



**PNEUMATIC TOOLS
FOR PROFESSIONALS
2020 CATALOG**

SP AIR CORPORATION



MADE IN JAPAN



⚠ WARNING

This must be read and understood by operating personnel and safety manager.
 Protection to operating personnel, as well as adjacent areas, shall be maintained and inspect tools in accordance with any applicable safety codes and regulations at all times.
 Stop using tools when tool produces unusual sound, repair immediately.



ISO9001



A complete range of high quality automotive, industrial and general service pneumatic tools manufactured in Japan for professionals.

Specifications subject to change without notice.
 Performance figures are at 90 psi pressure with 3/8"ID 2m long air hose.
IMPACT WRENCH:
 Torque figures developed on Skidmore-Wilhelm torque-tension tester at 90psi air pressure.
 Working torque figures are after 5 seconds of impacting.
 Maximum torque figures are after 15 seconds impacting.



SP AIR tools satisfy the requirements of EC Machine Directive (2006/42/EC).

- Measurements according to ISO-2787.
- Noise levels according to ISO-15744.
- Vibration levels according to ISO-8662, ISO-28927.

Warranty Policy

SP AIR Corporation offers a limited warranty against defects on all products. Basic warranty coverage is as follows:
 Limited Warranty - All Products One (1) Year from Date of Purchase. Warranty Procedure:
 Defective products within warranty will be replaced or repaired, and are not to be destroyed in the field.

- Faulty products in Warranty are to be returned to SP AIR Corporation customer service center address at right.
- The product will not be warranty protected unless you provide proof of purchase.

SP AIR USA, Inc.

1571 Westbelt Drive Columbus, OH 43228
 Toll Free : 855-438-5313
 TEL : 614-529-6600 FAX : 614-529-6700
 E-Mail : sales@spairusa.com

Contents

	Model	Page	
	SP-1764HD	1/4" Mini Impact Ratchet Wrench	3
	SP-1765HD	3/8" Mini Impact Ratchet Wrench	3
	SP-7260RP	1/4" The Perfect Impact Ratchet	4
	SP-7265RP	3/8" The Perfect Impact Ratchet	4
	SP-7730	3/8" Reaction Free High Speed Impact Ratchet	5
	SP-7250H	Low Profile Hex Bit Driver	6
	SP-7260	1/4" Sealed Flat Head Mini Ratchet	7
	SP-7265	3/8" Sealed Flat Head Mini Ratchet	7
	SP-7265W	3/8" Wobble Anvil Sealed Flat Head Mini Ratchet	7
	SP-7770	1/4" Rotational Head Ratchet Wrench	8
	SP-7772	3/8" Rotational Head Ratchet Wrench	8
	SP-7786	3/8" Heavy-Duty Sealed Flat Head Ratchet Wrench	9
	SP-7787	1/2" Heavy-Duty Sealed Flat Head Ratchet Wrench	9
	SP-7780	3/8" Heavy-Duty Sealed Flat Head Ratchet Wrench [Short Version]	10
	SP-7144	1/2" Composite Impact Wrench	11
	SP-1140EX	1/2" Heavy-Duty Impact Wrench	12
	SP-1140EXL	1/2" Heavy-Duty Impact Wrench [2"Extend Anvil]	12
	SP-7146EX	1/2" Composite Mini Impact Wrench	13
	SP-7146EXS	3/8" Composite Mini Impact Wrench	13
	SP-7825	3/8" Composite Mini Impact Wrench	14
	SP-7825S	1/4" Composite Mini Impact Wrench	14
	SP-1850	3/8" Palm Impact Wrench	15
	SP-1850S	1/4" Palm Impact Wrench	15
	SP-7150-V8	3/4" Composite Impact Wrench	16
	SP-1158	3/4" Impact Wrench	16
	SP-1193GE-6	1" Impact Wrench	17
	SP-1194DX-6	1" Impact Wrench	17
	SP-7610	Recipro Saw [Gear Type]	18
	SP-7231	3" Flex Head Cut-Off Tool	19
	SP-7231R	3" Reversible Flex Head Cut-Off Tool	20
	7231AWC	Adjustable Wheel Cover	21
	SP-7234	4" Extended Reach Cut Off Tool	22
	SP-1900	1/8" Micro Grinder	22
	SP-7220	1/4" Heavy-Duty Straight Die Grinder	23
	SP-7211	1/4" Heavy-Duty 90 degree Angle Head Die Grinder	23
	SP-7212	1/4" Heavy-Duty 120 degree Angle Head Die Grinder	23
	SP-7230	3" Cut-Off Tool	23
	SP-4BS	Carbide Burr 4pc Set for Ferrous Materials	24
	SP-4NF	Carbide Burr 4pc Set for Aluminum / Non-Ferrous Materials	24
	SP-7252F	Air Mini Beveler	25
	SP-1370A	3/8" & 1/2" x 13" Belt Sander	26
	SP-1380	3/4" x 20-1/2" Belt Sander	26
	SP-1350	5" High Speed Sander	27
	SP-7201DA	2" Mini D/A Sander	27
	SP-7500AHM	3" Mini Polisher	27
	SP-7527	1/2" Composite Air Drill	28
	SP-7527KL	1/2" Composite Air Drill [Keyless Chuck]	28
	SP-1460	Needle Scaler [Small]	29
	SP-1470	Needle Scaler [Large]	29
	SP-7825HU	1/4" Hex. Composite Impact Driver	30
	SP-7146HX	1/4" Hex. Composite Impact Driver	30
	SP-8102BU	1/4" Hex. Impact Driver	30

SP-1764HD

1/4" SUPER FAST MINI IMPACT RATCHET

SP-1765HD

3/8" SUPER FAST MINI IMPACT RATCHET

SUPER FAST

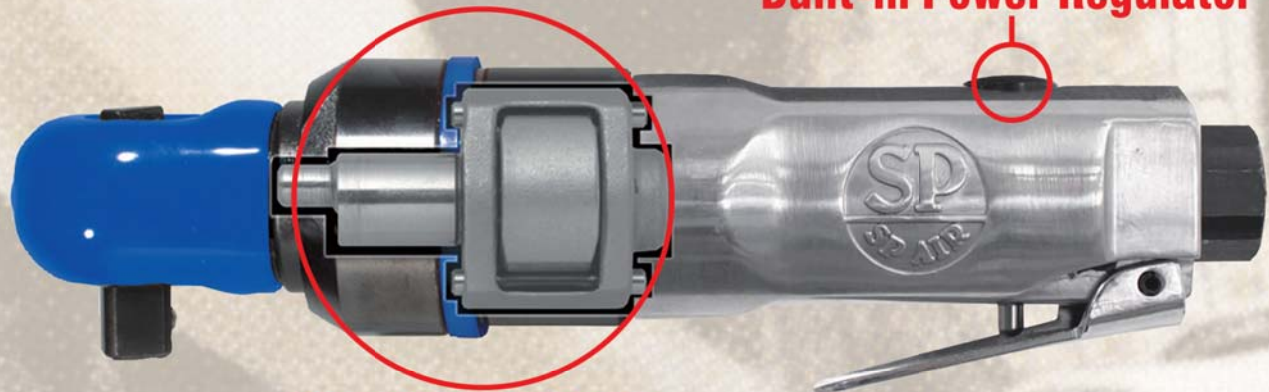
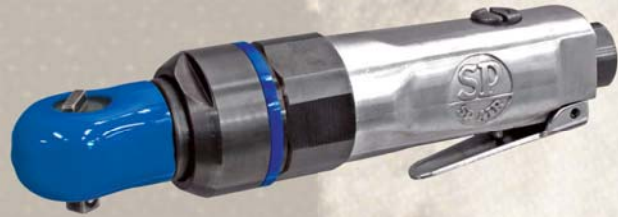

Built-in Power Regulator



**IMPACT MECHANISM
[PATENTED]**

Single Dog Clutch

Scan to watch Demo Video



High Speed



High Torque



Reaction Free

700rpm/55ft-lbs.

Model No.	Sq. Drive	Bolt Capacity	Max. Torque	Free Speed
SP-1764HD	1/4"	5/16"	55 ft-lbs.	700 rpm
SP-1765HD	3/8"	3/8"	55 ft-lbs.	700 rpm
	Overall Length	Net Weight	Sound Level	
SP-1764HD	6.9"	1.4 lbs.	84.4 dB	
SP-1765HD	6.9"	1.4 lbs.	84.4 dB	

SP-7260RP

1/4" THE PERFECT IMPACT RATCHET

SP-7265RP

3/8" THE PERFECT IMPACT RATCHET

SEALED FLAT RATCHET MECHANISM [PATENTED]

Sealed Flat Head For Long Life

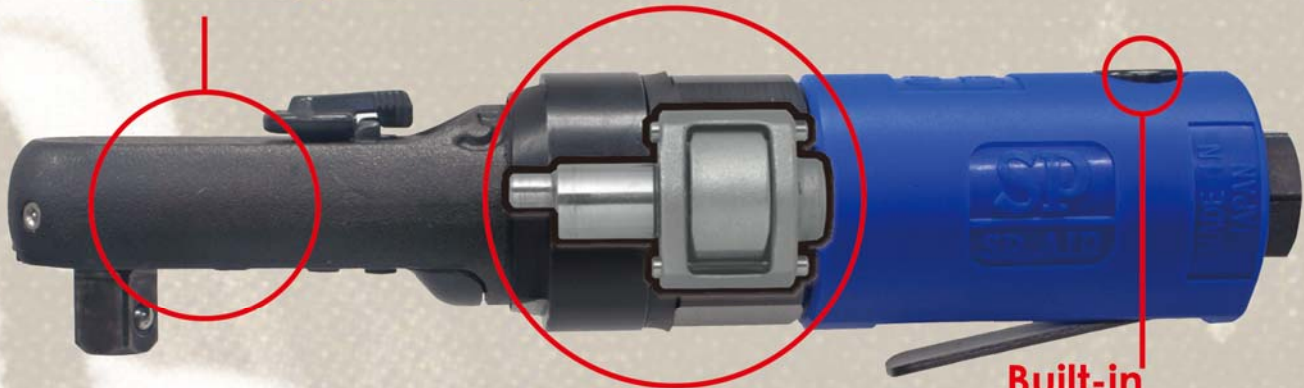

IMPACT MECHANISM [PATENTED]

Built-in
Power Regulator



Single Dog Clutch



Scan to watch
Demo Video



600rpm/45ft-lbs.

Model No.	Sq. Drive	Bolt Capacity	Max. Torque	Free Speed
SP-7260RP	1/4"	5/16"	45 ft-lbs.	600 rpm
SP-7265RP	3/8"	3/8"	45 ft-lbs.	600 rpm
	Overall Length	Net Weight	Sound Level	
SP-7260RP	7.5"	1.6 lbs.	88.1 dB	
SP-7265RP	7.5"	1.6 lbs.	88.1 dB	

SP-7730

3/8" REACTION FREE HIGH SPEED IMPACT RATCHET

HIGH TORQUE

SIZE COMPARISON

SP-7730 ▼



SP-1765HD
3/8" SUPER FAST MINI
IMPACT RATCHET ▶



**IMPACT MECHANISM
[PATENTED]**

Single Dog Clutch



Built-in Power Regulator

**Scan to watch
Demo Video**



450rpm/100ft-lbs.

Model No.	Sq. Drive	Bolt Capacity	Max. Torque	Free Speed
SP-7730	3/8"	3/8"	100 ft-lbs.	450 rpm
	Overall Length		Net Weight	Sound Level
SP-7730	11.6"		3.1 lbs.	88.2 dB

SP-7250H

LOW PROFILE HEX BIT DRIVER

- Low profile for use in tight areas
- Use with any 1/4" drive bit
- Ratchet style for ease of use



REVERSE LEVER

- One hand operation.

AIR REGULATOR



SEALED FLAT HEAD

Sealed Flat Head For Long Life



SWIVEL AIR INLET with 360° EXHAUST SLEEVE

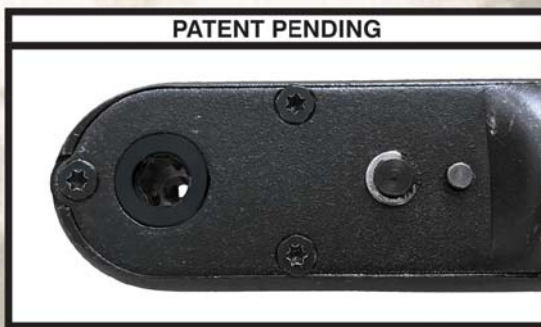

Model No.	Hex. Drive	Max. Torque	Free Speed
SP-7250H	1/4"	25 ft-lbs.	290 rpm
	Overall Length	Net Weight	Sound Level
SP-7250H	8"	1.5 lbs.	82 dB

SP-7260

1/4" SEALED FLAT HEAD MINI RATCHET

SP-7265

3/8" SEALED FLAT HEAD MINI RATCHET

SP-7265W

3/8" WOBBLE ANVIL SEALED FLAT HEAD MINI RATCHET

SEALED FLAT HEAD MINI RATCHET

Reverse Lever
• One-handed operation.

Built-in
Air Regulator

360°
Exhaust Sleeve



mini

Light Weight

[PATENTED] SEALED FLAT RATCHET MECHANISM



Sealed Flat Head for Long Life



Model No.	Sq. Drive	Bolt Capacity	Max. Torque	Free Speed
SP-7260	1/4"	5/16"	25 ft-lbs.	290 rpm
SP-7265	3/8"	3/8"	25 ft-lbs.	290 rpm
SP-7265W	3/8"	3/8"	25 ft-lbs.	290 rpm
	Overall Length		Net Weight	Sound Level
SP-7260	8"		1.5 lbs.	87 dB
SP-7265	8"		1.5 lbs.	87 dB
SP-7265W	8"		1.5 lbs.	87 dB

SP-7770

1/4" ROTATIONAL HEAD RATCHET WRENCH

SP-7772

3/8" ROTATIONAL HEAD RATCHET WRENCH



To adjust head, slide the ring forward and turn the ratchet housing. <PATENT PENDING>



Model No.	Sq. Drive	Bolt Capacity	Max. Torque	Free Speed
SP-7770	1/4"	5/16"	25 ft-lbs.	220 rpm
SP-7772	3/8"	3/8"	25 ft-lbs.	220 rpm
	Overall Length	Net Weight	Sound Level	
SP-7770	7.9"	1.3 lbs.	82 dB	
SP-7772	7.9"	1.3 lbs.	82 dB	

SP-7786

3/8" HEAVY-DUTY SEALED FLAT HEAD RATCHET WRENCH

SP-7787

1/2" HEAVY-DUTY SEALED FLAT HEAD RATCHET WRENCH

SEALED FLAT HEAD RATCHET



Reverse Lever
• One-handed operation.

High Power

Sealed head design promotes longevity of the tool by preventing ingress of dirt and debris. Shift-on-the-fly directional lever allows one-handed operation.

(PATENTED) SEALED FLAT RATCHET MECHANISM



Sealed Flat Head for Long Life



Model No.	Sq. Drive	Bolt Capacity	Max. Torque	Free Speed
SP-7786	3/8"	3/8"	80 ft-lbs.	200 rpm
SP-7787	1/2"	1/2"	80 ft-lbs.	200 rpm
	Overall Length	Net Weight	Sound Level	
SP-7786	12"	3.3 lbs.	84.5 dB	
SP-7787	12"	3.3 lbs.	84.5 dB	

SP-7780

3/8" HEAVY-DUTY SEALED FLAT HEAD RATCHET WRENCH [SHORT VERSION]

Reverse Lever
• One-handed operation.



High Power

Sealed head design promotes longevity of the tool by preventing ingress of dirt and debris.

Shift-on-the-fly directional lever allows one-handed operation.



(PATENTED) SEALED FLAT RATCHET MECHANISM



Sealed Flat Head for Long Life



Model No.	Sq. Drive	Bolt Capacity	Max. Torque	Free Speed
SP-7780	3/8"	3/8"	80 ft-lbs.	200 rpm
	Overall Length		Net Weight	Sound Level
SP-7780	9.75"		3.5 lbs.	82.6 dB

SP-7144

1/2" COMPOSITE IMPACT WRENCH

Composite body greatly reduces weight to allow longer, fatigue free, operation when compared to heavier models with comparable torque and speed specifications.



Twin Dog Clutch



SAS (Side And Side) System

Forward / Reverse for one hand operation.



Air Regulator

4 torque setting and full power reverse.

Model No.	Sq. Drive	Bolt Capacity	Max. Torque	Free Speed
SP-7144	1/2"	5/8"	(F) 750 ft-lbs. (R) 800 ft-lbs.	(F) 5,700 rpm (R) 6,500 rpm
	Overall Length		Net Weight	Sound Level
SP-7144	6.1"		4 lbs.	93.1 dB

SP-1140EX

1/2" HEAVY DUTY IMPACT WRENCH

SP-1140EXL

1/2" HEAVY DUTY IMPACT WRENCH
2" EXTEND ANVIL



Reverse Button



Twin Dog Clutch

Ideal choice for heavy automotive and truck work such as tire changing, shock and spring work, farm, body shop, front end work and anywhere else an extra powerful tool is needed.

Features

Twin dog clutch provides more power and smooth balanced blows.

Produced 800ft-lbs. of bolt removing torque.

Visual forward regulator with 4 torque settings and one full power reverse setting.

Model No.	Sq. Drive	Bolt Capacity	Max. Torque	Free Speed
SP-1140EX	1/2"	5/8"	800 ft-lbs.	6,000 rpm
SP-1140EXL	1/2"	5/8"	800 ft-lbs.	6,000 rpm
	Overall Length	Net Weight	Sound Level	
SP-1140EX	7.5"	5.7 lbs.	88.8 dB	
SP-1140EXL	9.5"	6.6 lbs.	88.8 dB	

SP-7146EX

1/2" COMPOSITE MINI IMPACT WRENCH

SP-7146EXS

3/8" COMPOSITE MINI IMPACT WRENCH

Ultralight



Compact with superb power



Twin Dog Clutch



SAS (Side And Side) System

Forward / Reverse for one hand operation.



Air Regulator

4 torque setting.

Model No.	Sq. Drive	Bolt Capacity	Max. Torque	Free Speed
SP-7146EX	1/2"	5/8"	440 ft-lbs.	10,000 rpm
SP-7146EXS	3/8"	1/2"	380 ft-lbs.	10,000 rpm
	Overall Length	Net Weight	Sound Level	
SP-7146EX	5.2"	2.1 lbs.	93.1 dB	
SP-7146EXS	5.2"	2.1 lbs.	93.1 dB	

SP-7825 SP-7825S

3/8" COMPOSITE MINI IMPACT WRENCH

1/4" COMPOSITE MINI IMPACT WRENCH

Ultralight



Double Hammer Clutch

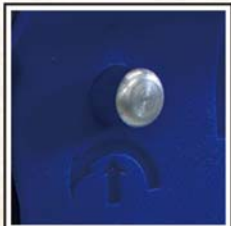

SAS (Side And Side) System

Forward / Reverse for one hand operation.



Air Regulator

4 torque setting.

Model No.	Sq. Drive	Bolt Capacity	Max. Torque	Free Speed
SP-7825	3/8"	3/8"	94 ft-lbs.	17,000 rpm
SP-7825S	1/4"	3/8"	94 ft-lbs.	17,000 rpm
	Overall Length	Net Weight	Sound Level	
SP-7825	4.3"	1.5 lbs.	84.2 dB	
SP-7825S	4.3"	1.5 lbs.	84.2 dB	

SP-1850

SP-1850S

3/8" PALM IMPACT WRENCH

1/4" PALM IMPACT WRENCH

ACTUAL SIZE



Butterfly Throttle Lever

Swivel inlet allows use in tight spaces.



Double Hammer Clutch



Air Regulator
4 torque settings.



Palm Size

Model No.	Sq. Drive	Bolt Capacity	Max. Torque	Free Speed
SP-1850	3/8"	3/8"	72 ft-lbs.	10,000 rpm
SP-1850S	1/4"	3/8"	72 ft-lbs.	10,000 rpm
	Overall Length		Net Weight	Sound Level
SP-1850	5.4"		1.0 lbs.	87.4 dB
SP-1850S	5.4"		1.0 lbs.	87.4 dB

SP-7150-V8

3/4" COMPOSITE IMPACT WRENCH



Twin Dog Clutch



SAS (Side And Side) System
Forward / Reverse for one hand operation.



Air Regulator
Forward, Reverse button with 4 torque setting.



Eight vane motor delivers hard-hitting torque of more than 1,000 ft-lbs while housed in a composite housing weighing less than 8 lbs.

SP-1158

3/4" IMPACT WRENCH



Single Dog Clutch

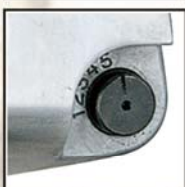

Air Regulator
Forward, Reverse button with 5 torque setting.



Model No.	Sq. Drive	Bolt Capacity	Max. Torque	Free Speed
SP-7150-V8	3/4"	1"	1,100 ft-lbs.	4,300 rpm
SP-1158	3/4"	1"	1,200 ft-lbs.	5,500 rpm
	Overall Length	Net Weight	Sound Level	
SP-7150-V8	9.3"	7.9 lbs.	94.9 dB	
SP-1158	8.7"	12.0 lbs.	93.5 dB	

SP-1193GE-6

1" IMPACT WRENCH

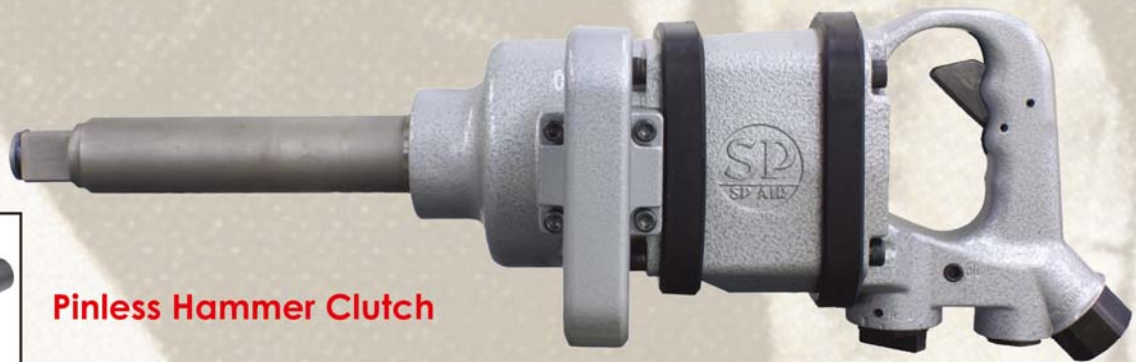

Pinless Hammer Clutch



Air Regulator
Forward, Reverse torque setting.

SP-1194DX-6

1" IMPACT WRENCH



Twin Dog Clutch
Twin dog clutch assembly operates within an oil bath to provide long life and reduced noise.



Air Regulator
4 torque setting.



Model No.	Sq. Drive	Bolt Capacity	Max. Torque	Free Speed
SP-1193GE-6	1"	1-1/2"	2,300 ft-lbs.	4,000 rpm
SP-1194DX-6	1"	1-1/2"	1,800 ft-lbs.	4,800 rpm
	Overall Length	Net Weight	Sound Level	
SP-1193GE-6	22"	28.7 lbs.	98.0 dB	
SP-1194DX-6	20.6"	17.2 lbs.	96.7 dB	

SP-7610 RECIPRO SAW (Gear Type)

- Reciprocating Saw with a gear mechanism is a motor driven saw with a powerful stroke, unlike the piston driven type.
- Cuts Steel, HTSS, FRP, Rubber, Resins and Bumpers etc.

Scan to watch Demo Video



<p>Blade Included</p>	<p>Tool Cutaway</p>
<p>SIDE VIEW</p>	
<p>(OPTION) 7610-200 Edge Blade</p>	<p>Accessories</p>
<p>Set of 10pcs.</p> <p>Durable 24 TPI blades.</p>	<p>Hex. Wrench x1</p> <p>Edge Blade x2</p>

Model No.	Stroke Per Minute	Stroke	Overall Length
SP-7610	5,300	0.47"	8.15"
	Net Weight	Sound Level	
SP-7610	1.3 lbs.	86.5 dB	

SP-7231

FLEX HEAD CUT-OFF TOOL
Disc Size : 3"



▼3-POSITION FLEX HEAD

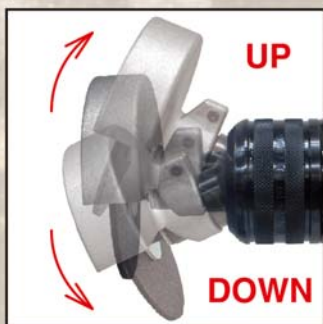

3-position, flexible head for greater access into tight work places. Ergonomic design cushion-grip handle. Rear exhaust. Safety throttle lever. Built-in power regulator. Direct drive motor. Graduated trigger. Metal guard. Cuts muffler clamps and hangers, sheet metal, radiator hose clamps, bumper bolts, and even steel rods up to 3/4".

Model No.	Disc Size	Free Speed	Overall Length
SP-7231	3"	18,000 rpm	8.6"
	Net Weight	Sound Level	
SP-7231	2.6 lbs.	90.0 dB	

SP-7231R

REVERSIBLE FLEX HEAD CUT-OFF TOOL
Disc Size : 3"

REVERSIBLE



Reversible Feature throws sparks and debris away from the operator.

▼ 3-POSITION FLEX HEAD



3-position, flexible head for greater access into tight work places. Ergonomic design cushion-grip handle. Rear exhaust. Safety throttle lever. Built-in power regulator. Direct drive motor. Graduated trigger. Metal guard. Cuts muffler clamps and hangers, sheet metal, radiator hose clamps, bumper bolts, and even steel rods up to 3/4".

Model No.	Disc Size	Free Speed	Overall Length
SP-7231R	3"	12,000 rpm	8.8"
	Net Weight	Sound Level	
SP-7231R	2.8 lbs.	90.0 dB	

7231AWC

ADJUSTABLE WHEEL COVER

- Fits SP AIR model #SP-7231, SP-7231R Fits also MAC AT35A (Mac Brand)
- Stabilizes cutting action
- Adjustable cut depth (Minimum 1/8")
- Protects sub-surface objects (Wiring Harnesses, etc...)
- Provides accurate and clean cuts 90 degree to surface

7231AWC
Adjustable Wheel
Cover



※ Tool Not Included

Scan to Watch Demo Video

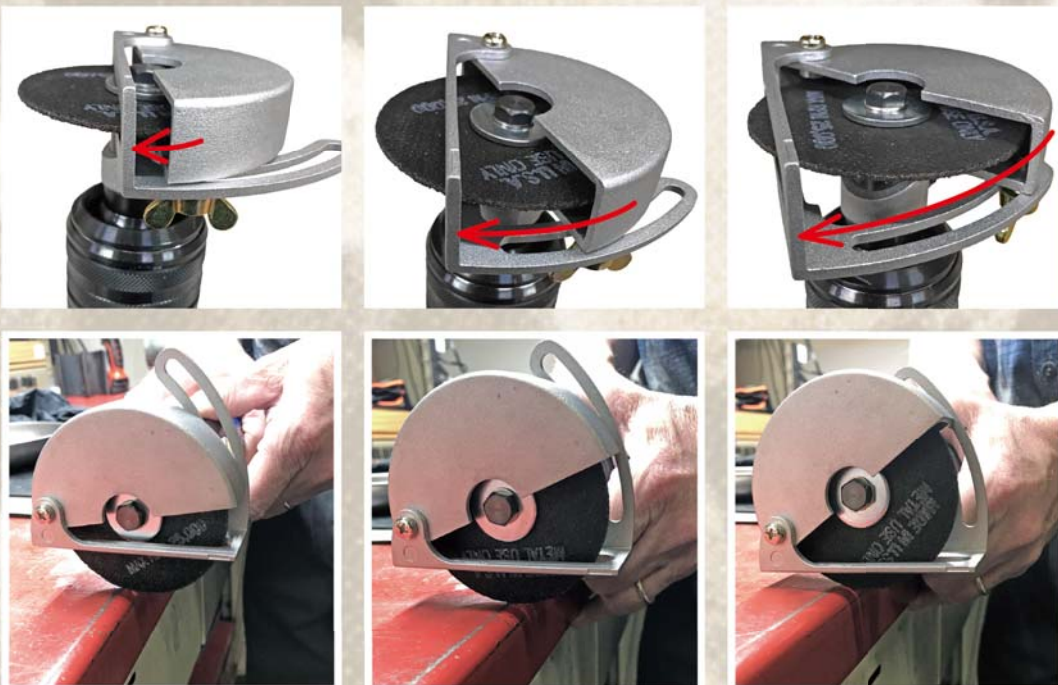

SP-1900

1/8" MICRO GRINDER

Features:

- Rear exhaust
- Flexible 59" long hose



SP-7234

4" EXTENDED REACH CUT OFF TOOL



Model No.	Disc Size	Collet Size	Free Speed
SP-1900	-	1/8"	70,000 rpm
SP-7234	4"	-	14,000 rpm
	Overall Length	Net Weight	
SP-1900	6"(without hose)	0.9 lbs.(without hose)	
SP-7234	13.8"	3.3 lbs.	

SP-7220

1/4" HEAVY-DUTY STRAIGHT DIE GRINDER



Ergonomic design cushion-grip handle. Rear exhaust. Built-in power regulator. Safety throttle lever. Direct drive motor with graduated trigger.

SP-7211

1/4" HEAVY-DUTY 90degree ANGLE HEAD DIE GRINDER



Ergonomic design cushion-grip handle. Rear exhaust. Built-in power regulator. Safety throttle lever.

SP-7212

1/4" HEAVY-DUTY 120degree ANGLE HEAD DIE GRINDER



120 degree Angle head. Ergonomic design cushion-grip handle. Rear exhaust. Built-in power regulator. Safety throttle lever.

SP-7230

CUT-OFF TOOL [DISC SIZE : 3"]



Ergonomic design cushion-grip handle. Rear exhaust. Safety throttle lever. Built-in power regulator. Direct drive motor. Graduated trigger. Metal guard. Cuts muffler clamps and hangers, sheet metal, radiator hose clamps, bumper bolts, and even steel rods up to 3/4".

Model No.	Collet Size	Disc Size	Free Speed
SP-7211	1/4"	-	18,000 rpm
SP-7212	1/4"	-	18,000 rpm
SP-7220	1/4"	-	20,000 rpm
SP-7230	-	3"	20,000 rpm
	Overall Length	Net Weight	Sound Level
SP-7211	6-7/8"	1.75 lbs.	87.8 dB
SP-7212	6-5/8"	1.69 lbs.	86.8 dB
SP-7220	6-7/8"	1.37 lbs.	90.1 dB
SP-7230	6-3/4"	1.50 lbs.	90.0 dB

SP-4BS

CARBIDE BURR 4pc SET FOR FERROUS MATERIALS

Feature & Benefit

For use with 1/4" High Speed Die Grinders.
For use in metalworking, mold and pattern making, die sinking, surface cleaning and maintenance.

Removes Burrs from Sheet metal or cast iron.
Cleans up welding areas.

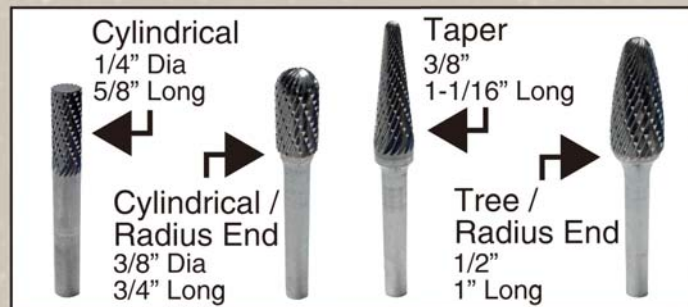

SP-4NF

CARBIDE BURR 4pc SET FOR ALUMINUM / NON-FERROUS MATERIALS

Feature & Benefit

Allowing rapid stock removal on non-ferrous and plastics materials

Avoiding Clogging

Ensures smooth cutting operation

Giving a guaranteed smoother grinding operation

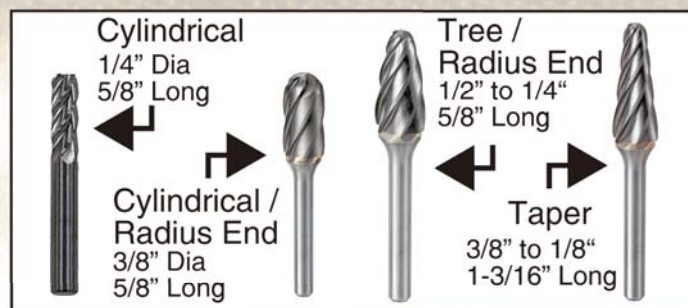

SP-7252F

AIR MINI BEVELER



Safety Throttle Lever

PALM SIZE



Scan to watch Demo Video

Front Exhaust for cooling metal.

Use the Palm Beveler to; Clean up welds, Beveling steel or aluminum edges for custom work. Automotive, Motorcycles, Marine and Aircraft uses. 45° Straight and Radius Blade available.



3 BLADE CUTTING HEAD



3 Edged Cutters

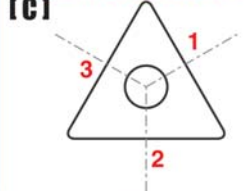

Flange with Scale To set depth of bevel.

APPLIED EXAMPLE

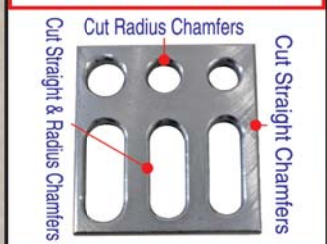

Machines chamfering capabilities

Cuts inside circles with a 0.27" diameter or more

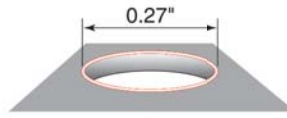

Cuts materials with a minimum of 0.1" thickness



Will make blind cuts with a minimum of 0.3" depth

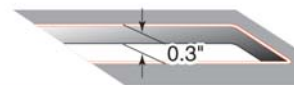

Model No.	Minimum Diameter	Chamfering Capacity	Free Speed
SP-7252F	0.27"	R0.06" C45°0.06"	23,000 rpm
	Overall Length	Net Weight	Sound Level
SP-7252F	4.4"	0.9 lbs.	81.5 dB

SP-1370A

3/8" & 1/2" x 13" BELT SANDER

Quick change belt guide allows belt replacement in seconds.



Belt Size
3/8" or 1/2"

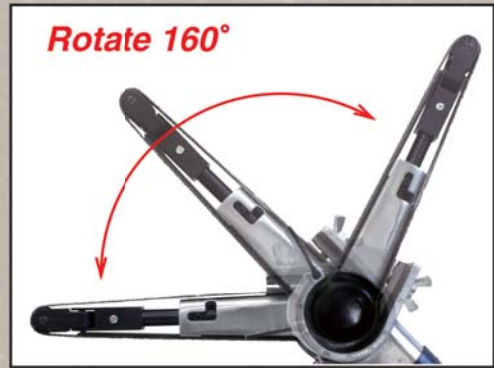

REPLACEMENT BELT



370-80-5P (60 Grit 3/8"x13")
Replacement Belt 5 Pack
370-80-10P (60 Grit 3/8"x13")
Replacement Belt 10 Pack

SP-1380

3/4" x 20-1/2" BELT SANDER



Belt Size
3/4"

REPLACEMENT BELT



380-60-5P (60 Grit 3/4"x20.5")
Replacement Belt 5 Pack
380-60-10P (60 Grit 3/4"x20.5")
Replacement Belt 10 Pack

Model No.	Belt Size	Free Speed	Overall Length
SP-1370A	3/8 & 1/2" x 13"	16,000 rpm	11"
SP-1380	3/4" x 20-1/2"	17,000 rpm	14.4"
	Net Weight	Sound Level	
SP-1370A	1.7 lbs.	82.0 dB	
SP-1380	3.1 lbs.	85.5 dB	

SP-1350

5" HIGH SPEED SANDER



Compact and lightweight.

SP-7201DA

2" MINI D/A SANDER



2" SANDING DISC 180 GRIT
 25 Pack #7201DA-18025P
 50 Pack #7201DA-18050P
 100 Pack #7201DA-180100P

2" SANDING DISC 320 GRIT
 25 Pack #7201DA-32025P
 50 Pack #7201DA-32050P
 100 Pack #7201DA-320100P

Compact and lightweight.

SP-7500AHM

3" MINI POLISHER

3" 100% Twist Wool Pad

3TWP ※Image

LOW SPEED SINGLE ACTION



- Well Balanced
- More Powerful
- Wide Range of Uses
- Polish Small Areas
- Polish Complex Shapes

Spindle Size: 5/16-24UNF

Model No.	Paper Size	Disc/Pad Size	Free Speed
SP-1350	5"	3" & 5"	15,000 rpm
SP-7201DA	-	2"	12,000 rpm
SP-7500AHM	-	3"	2,500 rpm
	Overall Length	Net Weight	Sound Level
SP-1350	5"	2.1 lbs.	77.8 dB
SP-7201DA	6.3"	1.3 lbs.	87.9 dB
SP-7500AHM	7.9"	1.7 lbs.	85.8 dB

SP-7527

SP-7527KL

1/2" COMPOSITE AIR DRILL

1/2" COMPOSITE AIR DRILL
[KEYLESS CHUCK]



**1/2"(13mm)
Drill Chuck**

**Light Weight
Composite Body**

400rpm

**1/2"(13mm)
Keyless Chuck**

Double Gear Mechanism

**Light Weight
Composite Body**



SAS (Side And Side) System

Forward / Reverse for one hand operation.



Air Exhaust with Muffler



Model No.	Chuck Size	Free Speed	Overall Length
SP-7527	1/2"	400 rpm	7"
SP-7527KL	1/2"	400 rpm	7.1"
	Net Weight	Sound Level	
SP-7527	2.9 lbs.	86.8 dB	
SP-7527KL	2.9 lbs.	86.8 dB	

SP-1460

NEEDLE SCALER [SMALL]

SP-1470

NEEDLE SCALER [LARGE]

SP-1460 ▼



SP-1470 ▼



Model No.	Piston Dia.	Piston Stroke	Number of Needles	Blows / min.
SP-1460	3/4"	1/2"	12pc	5,000 bpm
SP-1470	1"	7/8"	19pc	4,000 bpm
	Overall Length	Net Weight	Vibration Level:a	Air Consumption
SP-1460	9"	2.8 lbs.	27.87 m/s ²	0.8 cfm
SP-1470	16"	5.7 lbs.	31.68 m/s ²	2.0 cfm

SP-7825HU

1/4" HEX. COMPOSITE IMPACT DRIVER



Double Hammer Clutch



SAS (Side And Side) System

Forward / Reverse for one hand operation.



Air Regulator

Ultralight

1/4" Hexagonal

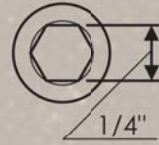
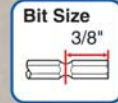

SP-7146HX

1/4" HEX. COMPOSITE IMPACT DRIVER



Double Hammer Clutch



SAS (Side And Side) System

Forward / Reverse for one hand operation.



Air Regulator

Ultralight

1/4" Hexagonal

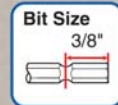

SP-8102BU

1/4" HEX. IMPACT DRIVER



Double Hammer Clutch



Reverse Lever



Air Regulator

1/4" Hexagonal

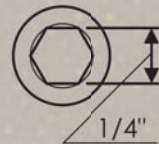

Model No.	Hex. Drive	Max. Torque	Free Speed
SP-7825HU	1/4"	94 ft.-lbs.	17,000 rpm
SP-7146HX	1/4"	100 ft.-lbs.	8,500 rpm
SP-8102BU	1/4"	100 ft.-lbs.	11,500 rpm
	Overall Length	Net Weight	Sound Level
SP-7825HU	4.7"	1.5 lbs.	85.5 dB
SP-7146HX	5.3"	2.1 lbs.	92.0 dB
SP-8102BU	6"	2.6 lbs.	90.0 dB

Manufacturer:



SP AIR CORPORATION

Tokyo, Japan

<http://www.spair.co.jp/>

USA Office:

SP AIR USA, Inc.

<http://www.spairusa.com/>

1571 Westbelt Drive Columbus, OH 43228-3829

Toll Free: 855-438-5313

TEL: 614-529-6600 FAX: 614-529-6700

E-Mail: sales@spairusa.com