

Makita®



2021.10

GENERAL CATALOGUE
KATALOG PRODUK 综合产品目录



XGT

40V^{Li-ION}max

XGT X2
80V^{max}



18V Lithium-ion



Teknologi Ekstrim Litium-ion
鋰离子技术

18V LITHIUM-ION

18V Lithium-ion | 18V 锂离子



18V x2

360+ TOOLS

6.0Ah 5.0Ah 4.0Ah
3.0Ah 2.0Ah 1.5Ah

Expand Your Lithium Line Up

INDEX Indeks 索引

CORDLESS Tanpa Kord 充电式	26 - 128
LED FLASHLIGHT Lampu Suluh LED LED 照明灯	129 - 133
VACUUM CLEANER Pembersih Vakum 吸尘器	134 - 167
DRILLING FASTENING Gerudi Pengetat 钻孔 紧固	168 - 173
IMPACT DRILLING DEMOLITION Gerudi Pemecah 石工钻孔 凿壁加工	174 - 185
CUTTING Pemotong 切割	186 - 192
GRINDING SANDING Pengisar Pelicin 研磨 打磨	193 - 211
SAWING Gergaji 锯切	212 - 219
PLANING ROUTERING Pengetam Tanggam 刨削 雕刻	220 - 223
OTHERS Lain-lain 其他	224 - 227
OUTDOOR POWER EQUIPMENT Alatan Kerja Luar 园林·户外	228 - 238
Makita -int-	239 - 248
1	
1805N	221
1911B	220
2	
2012NB	221
2107F	190
2416S	191
2704	214
2712	215
3	
3501N	221
3600H	223
3612BR	223
3709	222
3901	222
4	
4100KB	189
4100NH	189
4100NH2Z	189
4100NH3Z	189
4107R	189
4112HS	186
4114S	186
4131	186
4190DW	117
4300BV	218
4327	218

4327M	218
4329	217
4350CT	217
4351CT	217
4403	223
5	
5008MG	216
5016B	229
5103N	216
5402	217
5806B	216
6	
6016	169
6271DWE	117
6305	168
6413	168
6905B	172
6906	172
6922NB	173
6924N	173
9	
9031	210
9035H	210
9045B	210
9215SB	204
9237C	205
9401	209
9404	209
9553HBG	193
9553HNG	193
9556HNG / HN / NB	194
9556HPG / PB	194
9557HNG / NBG	196
9557HPG	196
9558HNG / NBG	198
9558HPG	198
9563C	195
9565CR / PC	199
9903	209
9911	209
9924DB	209
A	
ADP05	122
ADP06	123
ADP08	123
AF353	224
AF506	224
AF601	224
AF635	224
AT638A	225
B	

BBC231UZ BC231UDWBE	118
BHX2500	235
BML360Z	118
BO3710	210
BO4510H	211
BO4556	211
BO4901	210
BO5031	211
BO5041	211
BO6050J	211
BUH550RD / Z UH550DWB	118
BUH650RD / Z UH650DWB	118
BUN490RD	118
C	
CA5000X	192
CB100DB	128
CC300DW / DZ	114
CC301DWME / DWAE / DZ	108
CF100DZ	122
CF101DZ	122
CG100DZA	109
CL001GA127 / GA116 / GZ04 / GZ10	140
CL070DZ	147
CL100DW / DZ	146
CL102DW / DZ	146
CL104DWYX / DWY	146
CL105DW / DWX	147
CL106FDWYW / FDZW	145
CL107FDWYW / FDZW	145
CL108FDWYW / FDZW	145
CL111DWI / DWR	146
CL114FDWI	146
CL121DZ	145
CL183DZX	147
CP100DWA / DZ	107
D	
DA3010F	170
DA332DWAE / DZ	106
DBO180Z	87
DCB200B	128
DCC500Z	78
DCE090Z	45
DCF102Z	121
DCF201Z	121
DCF203Z	121
DCG180RFE / RFEB / ZB / Z	94
DCL180FRFW / RFB / ZB / Z	144
DCL181FZWX	144
DCL182FRFW / FZW	144
DCL184Z	145

DCL280FZW / FZB / FZ	143
DCL281FZW / FZB / FZ	143
DCL282FZW / FZ	143
DCL500Z	139
DCL501Z	139
DCM501Z	123
DCO180Z	92
DCO181Z	92
DCS231T	232
DCS520-53	230
DCS550RFE / Z	74
DCS551RFJ / Z	74
DCS552Z	73
DCS553Z	73
DCS6401-50	231
DCS7301-60	231
DCS7901-70	231
DCS9010-76	231
DCU180Z	101
DCV202YXL	128
DDA351Z	65
DDA450Z	65
DDA460ZK	39
DDF083RTE / RFE / Z	57
DDF453RME / RFE / SYE / Z	57
DDF458RME / RFE / Z	56
DDF459RME / Z	57
DDF481RTE / RME / RFE / Z	56
DDF482RME / RFE / Z	56
DDF483RTE / RME / RFE / Z	57
DDF484RTE / RME / RFE / Z	56
DDF485RFE / Z	56
DDF486RTE / Z	55
DDF487RAJ / Z	55
DDG460ZX7	44
DF001DW	116
DF001GD201 / GZ	29
DF002GD201 / GA201 / GZ	29
DF012DSE	115
DF0300	168
DF030DWE	113
DF031DSME / DWAE / DWYE / DZ	103
DF032DSME / DSAE / DZ	102
DF033DSME / DWAE / DZ	102
DF330DWE	113
DF331DSME / DZ	102
DF332DSME / DSAE / DZ	102
DF333DSME / DWAE / DWYE / DZ	102
DF488DWE	117
DFJ201ZM / ZL / ZXL	128
DFJ211ZM / ZL / ZXL	125

Double Insulation
Penebat Berganda | 双重绝缘

Variable Speed
Kelajuan Boleh Ubah | 无段变速

Brake
Brek | 电子自动刹车

Reversing
Mengundur | 正逆转

Electronic Ignition
Penyalakan Elektronik | 电子式启动装置

Mechanical 2-Speed
2-kelajuan Mekanikal | 机器式双速

Electronic 2-Speed
2-kelajuan Elektronik | 电子式双速

Electronic 3-Speed
3-kelajuan Elektronik | 电子式三速

Electronic 4-Speed
4-kelajuan Elektronik | 电子式四速

Keyless Chuck
Chuck Pengetatan Diri | 自锁夹头

Torque Setting 6
Pelarasan Tork 6 | 6档扭力调整

Torque Setting 9
Pelarasan Tork 9 | 9档扭力调整

Torque Setting 16
Pelarasan Tork 16 | 16档扭力调整

Torque Setting 18
Pelarasan Tork 18 | 18档扭力调整

Torque Setting 20
Pelarasan Tork 20 | 20档扭力调整

DFJ212ZM / ZL / ZXL	126
DFJ213ZM / ZL / ZXL	126
DFJ214ZM / ZL / ZXL	126
DFJ2140M / L / XL / ZXL	126
DFJ216ZL	125
DFJ300ZXL	127
DFJ311ZM / ZL / ZXL	125
DFJ400ZXL	127
DFJ411ZM / ZL / ZXL	125
DFJ416ZL	125
DFN350Z	93
DFR550Z	66
DFS250RTE / RFE / Z	66
DFS251RTE / RFE / Z	66
DFS452Z	66
DFV210ZM / ZL / ZXL / Z2XL	127
DFV214A01 / A02	127
DGA402RFE / Z	81
DGA404RTE / RFE / Z	80
DGA405RFE / Z	81
DGA406RME / RFE / Z	80
DGA408RME / RFE / Z	80
DGA411Z	79
DGA414Z	80
DGA418Z	80
DGA419Z	79
DGA452RME / RFE / Z	81
DGA456RFE / Z	81
DGA458RFE / Z	81
DGA505RFE / Z	83
DGA508RFE / Z	83
DGA511Z	82
DGA514Z	83
DGA518Z	83
DGA519Z	82
DGA700Z	40
DGA701Z	40
DGA900Z	40
DGA901Z	40
DGD800Z	84
DGD801Z	84
DGP180RT / Z	91
DHK180Z	73
DHP453RME / RFE / SYE / Z	61
DHP458RME / RFE / Z	60
DHP459Z	61
DHP481RTE / RFE / Z	60
DHP482RME / RFE / Z	60
DHP483RME / RFE / Z	61
DHP484RME / RFE / Z	60
DHP485RFE / Z	60

DHP487RAJ / Z	59
DHR165RME / RFE / Z	73
DHR171RTE / RFE / Z	72
DHR182ZWJ	72
DHR202RME / RFE / Z	72
DHR241RFE / Z	72
DHR242RTE / RME / RFE / Z	72
DHR263PM4 / RF4 / Z	39
DHR280PT2J / Z	38
DHR282PT2J / Z	38
DHR400ZKN	38
DHS630RME / RFE / Z	88
DHS661RFJ / Z	88
DHS680RMJ / RFJ / Z	88
DHS710RM2J / RF2J	42
DHS782Z	43
DHS783Z	43
DHS900PT2 / Z	43
DHW080ZK	54
DJN161Z	75
DJR181RFE	89
DJR183Z	89
DJR186RME / RFE / Z	89
DJR187RME / RFE / Z	89
DJR188Z	89
DJR360RF4 / Z	42
DJS101Z	74
DJS130RFE / Z	74
DJS161Z	74
DJV180RFE / Z	90
DJV181RFE / Z	90
DJV182RME / RFE / Z	90
DKP180RFE / Z	91
DKP181RTJ / Z	91
DLM160Z	97
DLM380Z	49
DLM382PT2 / CM2 / Z	49
DLM431PT2 / Z	49
DLM432PT2 / Z	49
DLM460Z	48
DLM532Z	48
DLM533Z	48
DLS111Z	41
DLS211Z	41
DLS600Z	87
DLS713RME / Z	87
DLS714PM2 / Z	41
DLW140Z	42
DML186	132
DML801	131
DML802	131

DML805	132
DML808	130
DML807	130
DML810	130
DML812	131
DMP180Z	94
DMR114	120
DMR203	120
DP2010	168
DPB180Z	77
DPB182Z	77
DPB183Z	78
DPB184Z	78
DPJ180Z	90
DPO500Z	84
DPO600Z	84
DPP200ZK	76
DPT353Z	93
DPV300Z	84
DRC200Z	138
DRS780Z	42
DRT50Z / ZJX9	92
DRV150Z	75
DRV250Z	75
DS4012	169
DS5000	169
DSC102ZJ	76
DSC121ZK	76
DSC162Z	77
DSC163ZK	77
DSC191Z	77
DSC251ZK	77
DSD180Z	90
DSL800Z	85
DSL801Z	85
DSP600Z	41
DSP601Z	41
DSS501Z	88
DSS610Z	88
DST121ZK	93
DST221Z	93
DST421ZK	93
DTD149RFE / Z	64
DTD152RME / RFE / Z	64
DTD153RTE / RFE / Z	63
DTD154RME / RFE / Z	63
DTD155RME / Z	64
DTD156SF / Z	64
DTD157RAJ / Z	63
DTD170RME / RFE / Z	63
DTD171RTJ / RFJ / Z	63

DTL061Z	65
DTL062Z	116
DTL063Z	71
DTM50Z	87
DTM51RFE / Z	87
DTM52RTJX1 / Z	86
DTP141RFE / Z	64
DTR180ZJ	75
DTS141RFE / Z	65
DTW152Z	116
DTW180Z	70
DTW181RFE / Z	70
DTW190RME / RFE / Z	70
DTW251RME / RFE / Z	69
DTW285RME / RFE / Z	69
DTW300RTJ / Z	69
DTW301RTJ / Z	69
DTW450RME / RFE / Z	69
DTW700RTJ / Z	68
DTW701RTJ / Z	68
DTW800RMJ / RFJ / Z	68
DTW1001RTJ / RMJ / RFJ / Z	68
DTW1002RTJ / RMJ / RFJ / Z	68
DUA300ZB	50
DUA301ZB	50
DUB182Z	100
DUB183Z	100
DUB185Z	100
DUB186Z	100
DUB361Z	53
DUB362RT2 / RM2 / Z	53
DUB363ZV	53
DUC122RME / Z	99
DUC252PM4 / Z	51
DUC254Z	99
DUC353Z	51
DUC355Z	51
DUC356Z	51
DUC406Z	50
DUH523RME / RFE / Z	97
DUH601Z	97
DUH651Z	52
DUH754SRT / SZ	97
DUM111SYX	99
DUM168Z	99
DUM604Z	99
DUN500WZ	98
DUN600LZ	98
DUP361Z	47
DUP362ZN	47

Torque Setting 21
Pelarasan Tork 21 | 21档扭力调整

SDS-PLUS Shank
Batang SDS-PLUS | 四坑柄

SDS-MAX Shank
Batang SDS-MAX | 五坑柄

17mm Hex Shank
Batang Heksagon 17mm | 17mm六角柄

30mm Hex Shank
Batang Heksagon 30mm | 30mm六角柄

21mm Hex Shank
Batang Heksagon 21mm | 21mm六角柄

28.6mm Hex Shank
Batang Heksagon 28.6mm | 28.6mm六角柄

Torque Limiter
Pengehad Tork | 扭力限制器 (安全离合器)

Constant Speed
Kelajuan Tetap | 电子定速

Soft Start
Penghidupan Secara Perlahan | 缓速起功

Bevel Cutting L45 R5
Pemotongan Serong Kiri 45° Kanan 5° | 斜角切割(左45°/右5°)

Bevel Cutting 45 left
Pemotongan Serong Kiri 45° | 斜角切割(左45°)

Bevel Cutting 45 LR
Pemotongan Serong Kiri Kanan 45° | 斜角切割(左右各45°)

Orbital Cutting
Pemotongan Orbit | 轨道切割

Makita Shank Jig Saw Blade
Bilah Gergaji Ukir Makita | M型式锯片

DUR181Z	96	EBH340R	228	GA5020	198	HM1317C	182
DUR182LRF / LZ	96	EE2650H	228	GA5030	197	HM1501 NEW	182
DUR184LZ	96	EH5000W	233	GA5030R	198	HM1511 NEW	183
DUR187LRF / LZ	96	EH6000W	233	GA5034	198	HM1810	183
DUR188LRF / LZ	95	EK6101	236	GA5040	199	HM1812	183
DUR188URFE	96	EK7651H / X1	236	GA5041C	199	HP001GD201 / GZ	29
DUR189Z	95	ELM3311X	236	GA5080R NEW	199	HP002GD201 / GA201 / GZ NEW	29
DUR190LRT2 / LZ2	95	ELM3320	235	GA6010	200	HP0300	174
DUR191LRT2 / LZ2 NEW	95	ELM3711X	235	GA6020C	200	HP1230	174
DUR192LST / LZ NEW	95	ELM3720	235	GA6040	200	HP1630	174
DUR364LPM4 / LRM2 / LZ	46	ELM4121	235	GA7020	202	HP2050	175
DUR368APT2 / AZ	47	EM3400U	228	GA7040R	202	HP330DWE	113
DUR368LPT2 / LZ	47	EN4951SH	233	GA7050	201	HP331DSME / DWAE / DWYE	103
DUR369LZ	46	ETR2500	228	GA7060	202	HP332DSME / DSAE / DZ	103
DUT130RFE / Z	73	EY2650H25H	232	GA7060R	201	HP333DSME / DWAE / DWYE / DZ	103
DUT131Z	73	F		GA7061R	201	HP488DWE NEW	117
DUX18RGX4 / Z NEW	97	FJ203DZL / DZLL	127	GA7062	201	HR001GM201	28
DUX60ZM3 / Z	52	FJ301DZM / DZL / DZLL	127	GA7063R	201	HR002GM201	28
DVC150LZ	135	FJ401DZL / DZLL / DZ3L	127	GA9020	203	HR003GM201 / GZ	28
DVC151LZ	135	FJ502DZM / ZL / ZLL	126	GA9050	202	HR005GM201 / GZ NEW	28
DVC152LZ	135	FN001GD101 / GZ NEW	34	GA9060	203	HR006GZ NEW	27
DVC153LZ	135	FS2300	170	GA9060R	203	HR140DWYE1	106
DVC154LZ / LZX	135	FS2500	170	GA9061R	203	HR166DSMJ / DWAJ / DZ	106
DVC155LZX3	136	FS2700	171	GB602	207	HR1830	175
DVC157LZX5	136	FS4200	171	GB801	208	HR1840	175
DVC260Z / ZX	138	FS6300	171	GD0600	205	HR1841F	175
DVC261Z	137	G		GD0601	206	HR2020	175
DVC265ZX	137	GA003GM201 / GD201 / GZ	31	GD0603	206	HR2320T / X2	176
DVC350Z	144	GA005GM201 / GD201 / GZ	32	GD0800C	206	HR2470X5	176
DVC560Z NEW	139	GA011GM201 / GD201 / GZ	31	GD0801C	206	HR2611FT	176
DVC660Z	138	GA013GM201 / GD201 / GZ	32	GD0811C	206	HR2630X3	176
DVC665Z	138	GA021GM201 / GD201 / GZ	31	GS5000	207	HR2631FTX2	176
DVC750LZ / LZX1	144	GA023GM201 / GD201 / GZ	32	GS6000	207	HR2652	177
DVC860LZ	136	GA027GM201 / GD201 / GZ	32	GV5010	204	HR2810	177
DVC862LPT2 / LRT2 / LZ	136	GA029GM201 / GD201 / GZ	32	GV6010	204	HR3001CJ NEW	177
DVC863LPT2 / LRT2 / LZ	136	GA035GZ NEW	33	GV7000C	204	HR3011FCJ NEW	177
DVC864LZ	137	GA036GZ NEW	33	H		HR3200C	178
DVC865LZX3 NEW	137	GA037GT201 / GM201 / GZ NEW	33	HB500	173	HR3210C	178
DVC867LZX1 NEW	137	GA038GT201 / GM201 / GZ NEW	33	HG5030K	226	HR3530	178
DVF154Z	101	GA4030	194	HG6031VK	226	HR4001C	178
DVP180Z	92	GA4030R	193	HG6530VK	225	HR4002	178
DVR450Z	94	GA4031	194	HK1820	183	HR4003C	179
DWR180Z NEW	71	GA4034	194	HM001GM202 / GZ NEW	28	HR4013C	179
DWT310ZK	39	GA4040	195	HM002GZ03 NEW	27	HR4030C	179
E		GA4040C	195	HM0810TA	180	HR4501C	179
EA3110T30B	231	GA4041C	195	HM0870C	181	HR4511C	179
EA3201S40B	230	GA4051R NEW	195	HM0871C	181	HR5202C	180
EA4301F45B	230	GA4530	196	HM1201	181	HR5211C	180
EA5600F53G	232	GA4530R	196	HM1203C	181	HR5212C	180
EA6100P	230	GA4540	197	HM1213C	181	HS004GM201 / GZ	34
EA7900P70E	230	GA4540R	197	HM1214C	182	HS0600	216
EB5300TH	234	GA4541C	197	HM1306	182	HS100	227
EB7660TH	234	GA5010	199	HM1307C	182	HS300DW	114

 **Bayonet Shank Jig Saw Blade**
Bilah Gergaji Ukir Jenis Bayonet | B型曲线锯锯片

 **Laser Marker**
Penanda Laser | 雷射标志

 **Hook & Loop**
Strap Velcro | 魔术贴式

 **Depth Adjustment**
Pelarasan Kedalaman | 深度调整

 **Anti Vibration**
Anti Getaran | 防震

 **Automatic Oiling**
Fungsi Pelinciran Automatik | 自动润滑功能

 **Chain Brake**
Brek Rantai | 链条刹车





 **Primer Pump**
Pam Utama | 按压吸油

 **Capacitor Discharge Ignition**
Pencucuhan Nyahcas Kapasitor | 电容放电式点火











 **Decompression Valve**
Injap Penyahmampatan | 减压阀

 **Auto Decompression**
Penyahmampatan Automatik | 自动减压



 **Rapid Start**
Penghidupan Cepat | 快速启动

HS301DSME / DWAE / DZ	108
HS6100	215
HS6600	215
HS7010	215
HS7600	215
HTR7610	233
HW102	238
HW121	238
HW1200	238
HW1300	238
J	
JN1601	191
JN3201	191
JR001GM201 / GZ	34
JR100DWE	115
JR102DWE	115
JR105DWAE / DZ	109
JR3050T	218
JR3051TK	219
JR3061T 	219
JR3070CT	219
JS1300	192
JS1601	192
JS1602	192
JS3201	192
JV0600K	218
JV100DWE	114
JV101DWAE / DWYE / DZ	108
JV102DZ	109
JV103DSMJ / DWAJ / DZ	109
K	
KP0800X	220
KP0810	220
L	
LB1200F	219
LC1230	187
LD030P	226
LD050P	227
LD080P / PI	227
LF1000	214
LH1201FL	213
LM001CZ 	48
LS002G 	33
LS0714	213
LS1018L	212
LS1019L	212
LS1030N 	214
LS1040	212
LS1219L	212
LS1440	214
LW1400	190
LW1401	190
M	

ML103	133
ML104	132
ML105	132
ML106	132
MLT100	214
MP100DZ	111
N	
N1900B	220
N5900B	216
P	
PC5000C	208
PC5001C	208
PC5010C	208
PJ7000	221
PK5001C	204
PLM4620N2	236
PLM5120N2	236
PM7650H	234
PO5000C	205
PO6000C	205
PT354DZ	109
PTR2500	234
PV301DZ 	108
PV7000C	205
PW5001C	208
R	
RP0900	222
RP1801	223
RP2301FC	222
RT0700C / X2	222
S	
SA5040C	203
SC103DZJ	107
SD100DWAJ / DZ	108
SG1251J	186
SJ401	219
SK104Z	226
SK105DZ	112
SK105GDZ	112
SK106DZ	112
SK106GDZ	112
SK209GDZ	112
SK312GDZ	112
SP6000J	217
T	
TD001GD201 / GZ	29
TD0100	170
TD0101F	170
TD020DSW	115
TD022DSE	115
TD090DWE	113
TD091DWE	114
TD110DSME / DWAE / DWYE / DZ	104

TD111DSME / DWAE / DWYE / DZ	103
TL064DSME / DWAE / DZ	106
TL065DSME / DWAE / DZ	106
TM30DWAE / DWAEX1 / DZ	107
TM3000C	207
TM3010CX6	207
TW001GM201 / GZ	30
TW005GD201 / GZ 	30
TW0200	173
TW0350	173
TW060DZ	105
TW100DWE	114
TW140DZ	104
TW141DSME / DWAE / DZ	104
TW160DZ	104
TW161DSME / DWAE / DZ	104
TW1000	172
U	
UB001CZ 	53
UB001GZ 	37
UB100DZ 	110
UB101DZ 	110
UB1103	227
UC3541A	229
UC3551A	229
UC4041A	229
UC4051A	229
UH004GZ 	36
UH006GZ 	36
UH201DWAX / DZ	111
UH353DWA	111
UH7580X	233
UM110DWYX 	117
UM600DWA / DZ	111
UR003GZ 	35
UR100DSME / DZ	111
UR201CZ	46
UT1305	172
UT2204	172
UX01GZ 	35
V	
VC1310LX1	155
VC2000L 	155
VC2211M	154
VC2510L	155
VC3210L	155
VC3211M	154
W	
WR100DWA / DZ	105

M0400G / M0400B	246
M0600G / M0600B	240
M0801G / M0801B	241
M0900G / M0900B	242
M0910G / M0910B	242
M1100G / M1100B	247
M1901G / M1901B	247
M1902G / M1902B	247
M2300G / M2300B	245
M2400G	246
M2401G / M2401B	247
M3600G / M3600B	247
M3601G / M3601B	247
M3700G / M3700B	248
M3701G / M3701B	248
M4000G / M4000B	248
M4001G / M4001B	248
M4100G / M4100B	246
M4301G / M4301B	246
M4302G / M4302B	245
M4501G / M4501B	246
M5801G / M5801B	245
M6001G / M6001B	240
M6200G / M6200B	240
M6501G / M6501B	240
M6600XG / M6600XB	240
M8100G / M8100B	241
M8103G / M8103B	241
M8600G / M8600B	242
M8700G / M8700B	241
M8701X3G / M8701X3B	241
M9000G / M9000B	244
M9001G / M9001B	244
M9002G / M9002B	243
M9200G / M9200B	245
M9201G / M9201B	245
M9202G / M9202B	244
M9204G / M9204B	244
M9400G / M9400B	244
M9503G / M9503B	243
M9504G	243
M9506G / M9506B	242
M9508G / M9508B	243
M9509G / M9509B	242
M9511G / M9511B	243
M9512G / M9512B	242
M9513G / M9513B	242
M9800G / M9800B	248

-  **Stainless Tank**
Tangki Tahan Karat | 不锈钢箱体
-  **Revolving Hose**
Hos Pusingan | 旋转软管
-  **Static Free Hose**
Hos Bebas Statik | 防静电胶管
-  **Dust Collecting**
Pengumpulan Habuk | 吸尘器连接

-  **Built-in Job Light**
Lampu Kerja Terbina | 内置工作灯
-  **Wooden Carrying Case**
Kotak Peralatan Kayu | 木制携带箱
-  **Carrying Case**
Kotak Peralatan | 携带箱
-  **Sequential or Bump-fire**
Sentakan Tunggal atau Berangkai | 连发模式

-  **Auto Firing Stop**
Nyalaan Terhenti Secara Auto | 自动停止发射
-  **Clutch-equipped**
Pelarasan tork | 扭力调整值



XGT is a new system with its own tools, batteries, and chargers. A combination of innovative tool design and higher output batteries provide a genuine solution for high demand industrial users.

XGT adalah sistem baru dengan alat, baterai dan pengecas yang unik. Kombinasi reka bentuk alat inovatif dengan baterai output tinggi memberikan penyelesaian bagi pengguna industri permintaan tinggi.

采用全新的XGT智能充电供电系统，具有独特的工具、电池和充电器。
创新的工具设计和高输出的电池相结合，为高需求的工业用户提供了真正的解决方案。

Tool ↔ Battery ↔ Battery Charger Digital communication

Alat Kuasa ↔ Bateri ↔ Pengecas Bateri | 工具 ↔ 电池 ↔ 充电器
Komunikasi digital | 数码通讯



Optimum power supply system and Optimum charging system

The XGT range of tools and batteries come with a built-in program, providing digital communication between the battery and tool. Allowing not only for the battery to talk with tool but also the tool to talk to the battery. Battery technology and motor engineering that work together for optimum performance.

Sistem Bekalan Kuasa dan Pengecasan Pintar XGT
Bateri alat kuasa siri XGT mempunyai program terpasang untuk mewujudkan komunikasi dua hala antara bateri dan alat kuasa. Prestasi yang optimum dicapai dengan komunikasi antara teknologi bateri dan kejuruteraan motor yang berfungsi bersama
XGT智能充电供电系统

XGT系列产品工具的电池都有一个内置程序，实现电池与工具之间双向的通信，使电池和电机达到理想的性能。

Optimum charging system

Auto maintenance system with two cooling fans for providing more optimum fast charging

Sistem pengecasan pintar
Pengecas mempunyai sistem penyelenggaraan automatik dan mempunyai dua kipas penyejuk
智能充电系统
充电器具有自动维护系统，并且拥有两个冷却风扇

Built Tough

High durability specifications specially designed for 40Vmax Li-ion batteries

Spesifikasi ketahanan tinggi direka khas untuk bateri Li-ion 40Vmax
专为40Vmax 锂电池设计的高耐用性结构

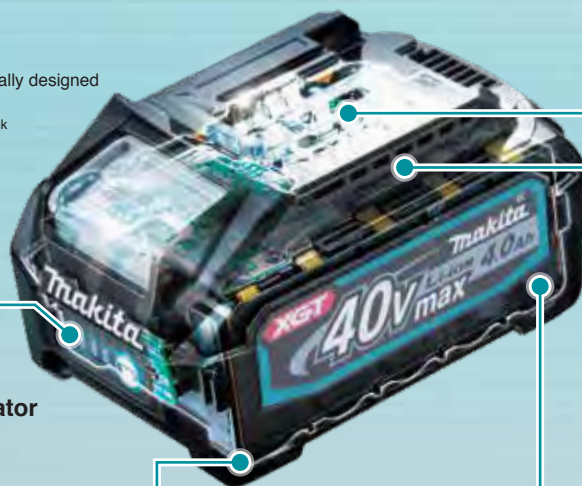

4-LED fuel gauge indicator

Penunjuk tahap bateri
电池电量计指示灯



Heavy duty outer casing and cell holder
Bekas lindung dan alas bateri yang kukuh 坚固的外壳和电池架

Create a space to absorb impact
Ruang tambahan untuk menyerap hentaman
创造额外吸收冲击力的空间

Shock absorption structure

Struktur penyerapan kejutan
减震结构

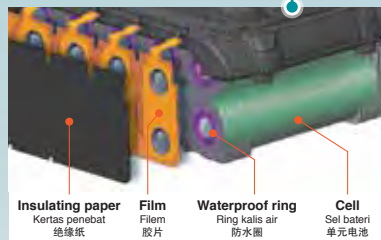

Insulating paper Kertas penebat 绝缘纸
Film Filem 胶片
Waterproof ring Ring kalis air 防水圈
Cell Sel bateri 单元电池

Waterproof Triple-layer Structure

prevents cell failure due to water and dust
Struktur kalis air tiga lapisan
Mencegah kerosakan bateri akibat air dan habuk
三层防水结构
防止因水和灰尘引起的电池故障



Terminal short-circuit prevention structure

The protection wall is provided between terminals against water and dust

Struktur pencegahan litar pintas terminal
Terdapat dinding pelindung kalis air dan tahan debu di antara terminal
端子防短路结构
端子之间设有防水防尘保护墙



High Rigidity Battery Rails

Durable slide in battery rail that holds the battery and the tools firmly and securely to withstand high power products

Slaid bateri berkekuatan tinggi
Slaid tahan lama di rel bateri untuk pegangan bateri dan alat kuasa dengan kukuh, sesuai untuk kerja yang berbeban tinggi
高强度电池滑轨
耐用的滑动式滑轨，可牢固地连接电池和工具，更适合高负荷的工作

OPTIMUM CHARGING SYSTEM

Sistem Pengecasan Terbaik 智能充电系统



• It is necessary to cool down before start charging when the battery temperature is high
Bateri yang baru diguna bersuhu tinggi, ia perlu didinginkan sebelum pengecasan bermula
刚使用完的电池处于高温状态, 要冷却后才能开始充电

• Built-in fan circulates air through the battery before start charging and during the charging process to cool the battery for faster charge time
Kipas akan terus menyejukkan bateri semasa pengecasan untuk mencapai pengecasan cepat
开始充电后, 风扇会持续冷却电池, 令充电时间更短

FAST CHARGING
Pengecasan Cepat 快速充电

22 MINUTES
to fully charge a 3.0Ah slide Li-ion battery

*Charge time may vary depending on battery model or conditions of use
Masa pengecasan mungkin berbeza bergantung kepada model bateri atau syarat penggunaan
充电时间可能因电池型号或使用条件而异



Makita

Optimum charging system

Sistem Pengecasan Terbaik 智能充电系统

Forced air cooling



Fast charging



Optimum charging system

Sistem Pengecasan Terbaik 智能充电系统

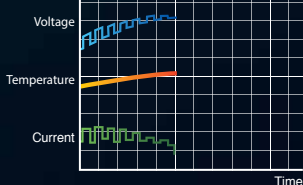

Competitor

General charging method

Kaedah Pengecasan Umum 一般充电方式

Natural heat dissipation



Waiting time for charging



General charging method

Kaedah Pengecasan Umum 一般充电方式

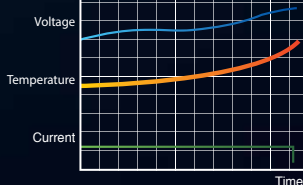

The Makita Rapid Optimum Charger communicates with the battery's built-in chip throughout the charging process to optimize battery life by actively controlling current, voltage and temperature

Makita Pengecas berkomunikasi dengan setiap sel unit dan mengawal arus, voltan dan suhu, membolehkan pengecasan pantas dan memanjangkan hayat bateri

Makita充电器与每个单元电池进行通信并控制电流, 电压和温度, 实现了快速充电, 且延长电池使用寿命

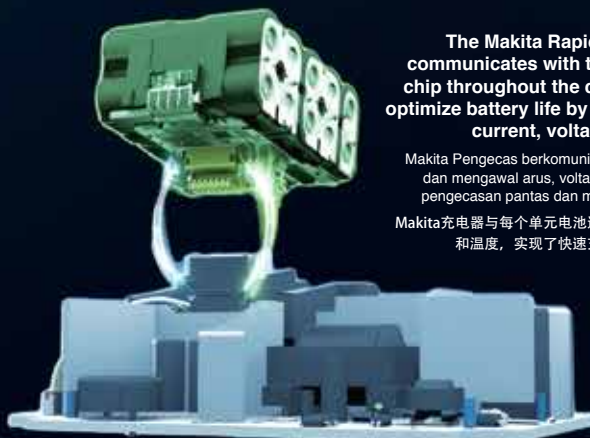

BATTERY PROTECTION FUNCTION

Fungsi Perlindungan Bateri 电池保护功能

Shock Absorbing

Tahan getaran 坚固耐震

Heavy Duty Pack
Pembungkusan tugas berat
重型包装

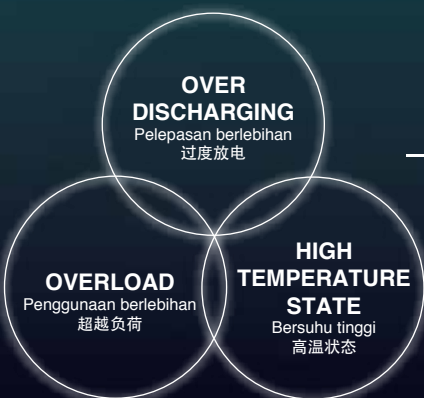

Built-In-CPU

CPU dibina dalam 内置CPU



Anytime Charge

Caj pada bila-bila masa 随时充电

- No Memory Effect
Tiada Kesan Memori 不受记忆影响
- No Discharging Required
Tiada pelepasan diperlukan 不需要放电



Teknologi Ekstrim Litium-ion
锂离子技术



12Vmax LITHIUM-ION
12V Lithium-ion
12V 锂离子

CXT
Teknologi Ekstrim Kompak
紧凑极限技术

OPTIMUM CHARGING SYSTEM

Sistem Pengecasan Terbaik 智能充电系统

FAST CHARGING
Pengecasan Cepat 快速充电
22 MINUTES
to fully charge a 1.5Ah slide Li-ion battery



* Charge time may vary depending on battery model or conditions of use
Masa pengecasan mungkin berbeza bergantung kepada model bateri atau syarat penggunaan
充电时间可能因电池型号或使用条件而异



LI-ION BATTERY

Sistem bateri Li-ion 锂电池系统

Multi-Contact Slide-type Terminal

Terminal slaid dengan pelbagai sambungan
多触点滑动式终端

- Ensures stable contact with tool even under extreme vibration
- Allows tools to be equipped with an ergonomic handle design
- Memastikan sambungan yang stabil dengan alat walaupun di bawah getaran yang melampau
- Membolehkan alat dilengkapi dengan reka bentuk pemegang ergonomik
- 即使在极端的振动下也能确保与工具的稳定连接
- 允许工具配备符合人体工程学的手柄设计



Battery fuel gauge

Penunjuk Tahap Bateri 电量显示

The power remaining in the battery can be indicated in 4 stages simply by pushing a button

Menekan butang untuk penunjuk tahap bateri
只需按一下按钮，电池中剩余的电量就可以分四个阶段显示出来



Charging status indicator

Penunjuk Status Mencegas 充电状态显示灯



shows the charging status of a battery being charged in 2 stages: less than 80% and 80% or more.

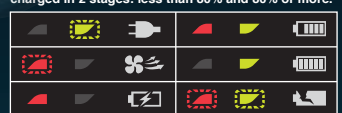

BATTERY & CHARGER TIME REFERENCE, COMPATIBILITY CHART

Panduan tempoh pengecasan dan bateri 电池充电时间参考表, 兼容性图表

		<p>5.0Ah BL4050F (-)</p>	<p>4.0Ah BL4040 (191B26-6)</p>	<p>2.5Ah BL4025 (191B36-3)</p>	<p>2.0Ah BL4020 (191L29-0)</p>
<p>Fast Charger DC40RA (191E08-6) Pengecas Pantas 快速充电器</p>	<p>Two Port Multi Fast Charger DC40RB (191N14-5) Pengecas Pantas Dua Port 两端快速充电器</p>	<p>50 min. </p>	<p>45 min. </p>	<p>28 min. </p>	<p>22 min. </p>
<p>Standard Charger DC40RC (191M92-9) Pengecas Standard 标准充电器</p>		<p>85 min.</p>	<p>67 min.</p>	<p>38 min.</p>	<p>30 min.</p>

		<p>Fast Charger DC40RA (191E08-6) Pengecas Pantas 快速充电器</p>	<p>Adapter ADP10 (191C11-5)</p>	<p>Rapid Charger DC18RC (195586-8) Pengecas Pantas 快速充电器</p>	<p>Two Port Multi Rapid Charger DC18RD (196934-4) (630869-4) Pengecas Pantas Dua Port 两端快速充电器</p>	<p>Dual Port Fast Charger DC18RE (198446-3) Pengecas Pantas Dua Port 两端快速充电器</p>	<p>Standard Charger DC18SD (194534-4) Pengecas Standard 标准充电器</p>	<p>Automotive Charger DC18SE (194618-8) Pengecas Automotif 汽车充电器</p>
<p>6.0Ah BL1860B (197422-4)</p>	<p>40 min.</p>	<p>55 min. </p>	<p>130 min.</p>					
<p>5.0Ah BL1850B (197282-4)</p>	<p>40 min.</p>	<p>45 min. </p>	<p>110 min.</p>					
<p>4.0Ah BL1840B (197265-4) (197267-0)</p>	<p>29 min.</p>	<p>36 min. </p>	<p>90 min.</p>					
<p>3.0Ah BL1830B (197599-5)</p>	<p>22 min.</p>	<p>22 min. </p>	<p>60 min.</p>					
<p>2.0Ah BL1820B (197256-5)</p>	<p>24 min.</p>	<p>24 min. </p>	<p>45 min.</p>					
<p>1.5Ah BL1815N (196235-0)</p>	<p>15 min.</p>	<p>15 min. </p>	<p>30 min.</p>					
<p>1.3Ah BL1815 (194513-2)</p>	<p>15 min.</p>	<p>15 min. </p>	<p>30 min.</p>					

		<p>Speed Charger DC10SB (197346-4) Pengecas Pantas 快速充电器</p>	<p>Dual Port Fast Charger DC18RE (198446-3) Pengecas Pantas Dua Port 两端快速充电器</p>	<p>Standard Charger DC10WD (197450-9) Pengecas Standard 标准充电器</p>			<p>Standard Charger DC10WA (194589-9) Pengecas Standard 标准充电器</p>
<p>4.0Ah BL1041B (197406-2)</p>	<p>60 min. </p>	<p>130 min.</p>	<p>1.3Ah BL1013 (194550-6) (196066-7)</p>	<p>1.0Ah BL7010 (194355-4)</p>	<p>50 min. BL1013</p>	<p>30 min. BL7010</p>	
<p>2.0Ah BL1021B (197396-9)</p>	<p>30 min. </p>	<p>70 min.</p>	<p>18V G-Battery</p>		<p>Standard Charger DC18WA (195424-4) Pengecas Standard 标准充电器</p>		
<p>1.5Ah BL1016 (197393-5)</p>	<p>22 min. </p>	<p>50 min.</p>	<p>1.5Ah BL1815G (198186-3)</p>	<p>70 min.</p>			

<p>14.4V Ni-MH</p>	<p>12V Ni-MH</p>	<p>9.6V Ni-MH</p>	<p>Standard Charger DC18SD (194534-4)</p>	<p>Automotive Charger DC18SE (194618-8)</p>	<p>12V Ni-CD</p>	<p>9.6V Ni-CD</p>	<p>Standard Charger DC1414 (193865-8)</p>			
<p>3.1Ah BH1433 (193354-3)</p>	<p>3.1Ah BH1233C (193930-3)</p>	<p>3.1Ah BH9033A (193591-9)</p>	<p>70 min.</p>	<p>70 min.</p>	<p>1.9Ah 1222 (192597-4)</p>	<p>—</p>	<p>45 min.</p>			
<p>1.8Ah BH1420 (193351-9)</p>	<p>1.8Ah BH1220C (193928-0)</p>	<p>1.8Ah BH9020 (193631-3)</p>	<p>40 min.</p>	<p>40 min.</p>	<p>1.3Ah PA12 (193981-6)</p>	<p>1.3Ah 1220 (192681-5)</p>	<p>1.3Ah PA09 (193977-7)</p>	<p>1.3Ah 9120 (192638-6)</p>	<p>1.3Ah 9100 (192019-4)</p>	<p>30 min.</p>
<p>14.4V Ni-MH</p>	<p>12V Ni-MH</p>	<p>9.6V Ni-MH</p>	<p>Standard Charger DC1414 (193865-8)</p>		<p>9.6V Ni-CD</p>	<p>7.2V Ni-CD</p>	<p>Standard Charger DC1414 (193865-8)</p>			
<p>2.8Ah 1435 (193060-0)</p>	<p>2.8Ah 1235 (193059-5)</p>	<p>2.8Ah 9135 (193058-7)</p>	<p>70 min.</p>		<p>1.3Ah 9000 (191681-2)</p>	<p>1.3Ah 7000 (191679-9)</p>	<p>30 min.</p>			

BATTERY INFORMATION

Maklumat Bateri 关于电池的资讯

How to Keep Your Batteries at Their Best

Cara menggunakan prestasi bateri yang terbaik 如何使用才能发挥电池的最佳效能

Note the precautions below for keeping your batteries (Ni-Cd, Ni-MH, Li-ion) at their best to obtain maximum potential cycle life of batteries.

Perhatikan langkah penjagaan bateri berikut untuk memastikan bateri anda (Ni-Cd, Ni-MH, Li-ion) berada pada tahap terbaik untuk jangka hayat bateri berpotensi maksimum. 关于电池（镍镉、镍氢、锂电池）的最佳使用方法请参照下面的注意项目。电池将可得到最大的使用寿命。

1. No over-discharge

Stop using a tool and charge the battery when the tool power goes down or its motor speed slows down. Do not use a cordless tool when its power goes down. Otherwise, it will cause an imbalance of battery cells and reduction of battery cycle life.

Elakkan pelepasan berlebihan. Jika alat kuasa anda daya lemah (pengurangan kelajuan putaran motor) semasa penggunaan, berhenti menggunakannya dengan segera dan mengecas bateri (bateri dapat diisi semasa suhu turun ke suhu bilik). Dilarang terus menggunakan alat kuasa apabila kekuatannya semakin lemah kerana ketidakseimbangan sel bateri akan mengurangkan jangka hayat bateri.

避免过度放电在使用工具中如果感觉到力道减弱(马达的回转速降低)时, 须马上停止使用且稍后(电池温度降至室温即可充电)进行充电。严禁工具的力道减弱时还继续的使用。会因为元件容量的不均而导致电池寿命的短缺。

2. No quick discharge

Avoid overloading during tool operation that causes quick discharge.

Elakkan beban berlebihan semasa operasi alat kuasa yang akan menyebabkan pelepasan cepat.

避免急速放电使用时请注意避免有过负载现象发生。

3. No over-charge

Recharging a fully charged battery is called "Over-charge". This will cause reduction of battery cycle life.

Elakkan pengecasan berlebihan. Mengecas semula bateri yang dicas penuh disebut "Over-charge". Ini akan mengurangkan jangka hayat bateri.

避免过度充电。充电后满电状态又再次作充电动作。这称为[过充电]。是导致电池寿命降低的原因。

If a fully charged battery is about to be charged, Makita automatic maintenance function will stop recharging immediately to prevent battery deterioration.

Sekiranya bateri yang penuh dicas semula, fungsi penyelenggaraan automatik akan diaktifkan untuk menghentikan tindakan pengecasan untuk mengelakkan kerosakan bateri. 牧田滑动式电池对于充满电后又再次作充电时, 自动保养机能会启动, 将充电动作停止, 防止电池的劣化产生。

4. Charge your batteries at an ambient temperature from 10°C to 40°C

Do not charge batteries cold from storage at a low ambient temperature below 10°C, or they are damaged. Also batteries are damaged at a high ambient temperature above 40°C. as the deterioration of battery cell materials are hastened by such a high temperature. Therefore, optimum air temperature for charging of batteries is from 10°C to 40°C. When you recharge a battery hot from operation of tool, do not leave it in the tool, but set it on the Makita charger for slide style batteries that will cool down the hot battery fast and efficiently with its forced air cooling system before recharging. This unique system will surely protect batteries from deterioration from heat.

Mengecas bateri yang disimpan pada suhu persekitaran antara 10 °C hingga 40 °C. Pengecasan bateri yang disimpan pada suhu persekitaran rendah (di bawah 10 °C) akan menyebabkan kerosakan bateri. Pengecasan bateri yang disimpan pada suhu persekitaran tinggi (melebihi 40 °C), kemerosotan bahan dalaman bateri akan dipercepat dan menyebabkan kerosakan bateri. Keluarkan bateri yang panas dari alat kuasa selepas penggunaan dan letakkan bateri pada pengecas. Pengecas Makita akan menyejukkan bateri panas dengan cepat dan cekap dengan sistem penyejukan sebelum mengecas semula. Sistem yang unik ini melindungi bateri daripada kerosakan akibat panas.

在10°C以下的低温环境中保管的电池如果进行充电, 将对电池的本身造成伤害。另外, 在40°C以上的高温环境下, 会加速电池内部材料的劣化, 也会对电池的本身造成伤害。在10°C~40°C的温度内充电是最合适的。刚使用完且还有些发热的状态的电池, 不要插在电动工具上。需移置到充电器。充电器的冷却装置会很有效率的将电池散热后再进行充电, 如此, 可以防止发热导致电池劣化的情形发生。

5. Keep your batteries away from moisture

High humidity and extreme temperature swings cause dew drop, and it will cause rust and short-circuit.

Elakkan bateri dari wap air. Kelembapan tinggi dan perubahan suhu yang melampau akan menyebabkan karat dan litar pintas.

不要触碰水气。生锈是短路的原因, 高温, 极端的温度差会导致结露现象产生。

6. Do not exert any significant impact on batteries

String impact on battery will cause internal wire breakage or cracks on battery housing.

Elakkan hentakan ketara yang akan menyebabkan kerosakan wayar dalaman atau keretakan pada penutup bateri.

不要强烈撞击, 外壳的破损, 是内部断线的原因。

Charge the battery when the motor speed slows down!
Mengecas bateri apabila kelajuan motor alat kuasa menjadi perlahan
转速降低时, 立即停止使用, 准备充电!



Battery Care & Storage

Penjagaan & simpanan bateri 电池的保管方法

Store batteries at an ambient temperature below 35°C. Avoid storing batteries at a high air temperature and humidity

Simpan bateri pada suhu persekitaran di bawah 35°C, elakkan menyimpan bateri pada suhu dan kelembapan udara yang tinggi 将电池存放在低于35°C的环境温度下, 避免将电池存放在空气温度高和湿度高的地方

<p>Storage in fully charged condition</p> <p>Jenis bateri yang mesti disimpan dalam keadaan terisi penuh 须在充满电状态下保管的电池种类</p>  <p>Li-ion Battery Bateri Li-ion 锂电池</p>	 <p>Ni-MH Battery Bateri Ni-MH 镍氢电池</p>	<p>Storage in fully discharged condition</p> <p>Jenis bateri yang mesti disimpan dalam keadaan havis 须在放电状态下保管的电池种类</p>  <p>Ni-CD Battery Bateri Ni-CD 镍镉电池</p>
--	---	--

※ Ni-MH batteries have to be charged once a year due to its self-discharging nature. Bateri Ni-MH harus dicas setahun sekali kerana ciri pelepasan diri. 由于镍氢电池自放电特性, 建议每年充电一次。

※ Ni-CD batteries have to be fully discharged before storage. After storage for sometimes, ensure Ni-CD batteries are fully charged before use. Bateri Ni-CD mesti dilepaskan sepenuhnya sebelum disimpan. Setelah disimpan untuk jangka waktu tertentu, pastikan bateri Ni-CD dicas penuh sebelum digunakan. 镍镉电池必须在存放前完全放电。存放一段时间后, 请确保镍镉电池在使用前已充满电。

CORDLESS ADVANTAGE

Tanpa Kord 充电式优势

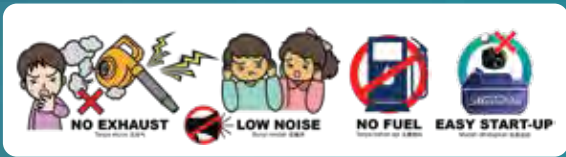

Easy to Use

Mudah digunakan 方便使用

Start-up

Dihidupkan 启动

Engine tools

Alat kuasa enjin 引擎工具



Engine tools need time and tips to start-up
Alat kuasa enjin memerlukan masa untuk dihidupkan
引擎工具需要时间和技巧来启动

Cordless tools

Alat kuasa tanpa kord 充电式工具



Cordless tools start just after inserting battery and switching on
Alat kuasa tanpa kord mudah dihidupkan dengan pemasangan bateri sahaja
安装电池后并开启充电式工具便可开始工作

Constant speed control

Kelajuan tetap 电子恒速控制

Engine tools

Alat kuasa enjin 引擎工具



Engine tools are hard to keep the constant rotation speed under load

Alat kuasa enjin sukar untuk mengekalkan kelajuan putaran berterusan
引擎工具很难在负载下保持恒定的转速

Cordless tools

Alat kuasa tanpa kord 充电式工具



Cordless tools keep rotation speed under load with "Constant speed control" function

Alat kuasa tanpa kord berfungsi "kawalan kelajuan putaran berterusan"
充电式工具保持旋转"恒定负载下的速度"控制功能

Low noise (Noise level comparison)

Bunyi rendah 低噪声

Engine tools

Alat kuasa enjin 引擎工具



Cordless tools

Alat kuasa tanpa kord 充电式工具



Clean & Easy Maintenance

Bersih dan mudah dijaga 清洁和容易保养



Zero emission

Tanpa pelepasan asap 无排气

Engine tools

Alat kuasa enjin 引擎工具



Cordless tools

Alat kuasa tanpa kord 充电式工具



Cordless tools don't generate any exhaust gas
Alat kuasa tanpa kord tidak mengeluarkan gas ekzos
充电式工具不会产生废气

Cost and time reduction

Kurangkan kos dan masa 减少成本和减少时间

Engine tools

Alat kuasa enjin 引擎工具



It takes time to prepare mixed fuel for engine
Mengambil masa untuk menyediakan bahan api campuran untuk Enjin
需时为发动机准备混合燃料

Cordless tools

Alat kuasa tanpa kord 充电式工具



Just insert battery and ready to use
Pasangkan bateri dan sedia untuk digunakan
只需安装电池即可使用

Easy maintenance

Penyelenggaraan mudah 易于维护

Engine tools

Alat kuasa enjin 引擎工具

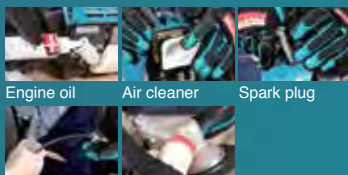

Fuel plug Grease up

Cordless tools

Alat kuasa tanpa kord 充电式工具



Cordless tools are maintenance - Free unlike engine tools
Alat kuasa tanpa kord bebas dari penyelenggaraan
充电式工具免维护

Long term storage

Penyimpanan jangka panjang 长期存放

Engine tools

Alat kuasa enjin 引擎工具



If you store the tool for a long period, when the fuel remained in the tank It may be a cause of trouble or defect

Alat kuasa enjin mungkin akan rosak sekiranya disimpan lama dengan bahan api dalam tangki
燃油长时间存放在油箱可能会造成工具故障

Cordless tools

Alat kuasa tanpa kord 充电式工具



Even if you store the tools for a long period, Just insert battery and ready to use

Walaupun menyimpan dalam jangka masa yang panjang, alat kuasa tanpa kord sedia digunakan dengan pemasangan bateri
充电式工具即使长时间存放, 只需安装电池即可使用



Motor tanpa berus
无碳刷马达

Purpose-built Brushless Motors

Motor tanpa berus 无碳刷马达

Makita-built Brushless Motor eliminates carbon brushes, enabling the motor to run cooler and more efficiently for longer life. The electronically controlled Brushless Motor efficiently uses energy to match torque and RPM to the changing demands of the application

Motor tanpa berus yang dibuat oleh Makita menghapuskan berus karbon, membolehkan motor berjalan lebih sejuk, lebih cekap dan lebih tahan lama. Motor tanpa berus yang dikawal secara elektronik dengan cekap menggunakan tenaga untuk menyesuaikan tork dan RPM kepada perubahan permintaan aplikasi
Makita制造的无碳刷马达消除了碳刷, 使马达更冷却的运作, 更有效, 更长使用寿命。电子控制的无碳刷马达有效地利用能量将扭矩和RPM以配合不断变化的需求



XPT

EXTREME PROTECTION TECHNOLOGY

Teknologi Perlindungan Ekstrim
防尘防水滴技术

Enhanced dust and drip-resistant performance of the tools

Prestasi tahan debu dan tahan titisan air
提高工具的防尘与防水滴性能, 令工具更耐用



Dust-resistant

Tahan debu 防尘



Drip-resistant

Tahan titisan air 防水滴

The pictures do not mean to ensure the products are perfectly durable against dust and water, though they are designed to prevent dust and water ingress.
Walaupun XPT direka untuk tahan titisan air dan tahan debu, ia tidak menjamin berlakunya kerosakan alat kuasa yang disebabkan oleh air atau debu
注意: 照片为示意图。
XPT设计虽然可以抑制水或粉尘所带来的影响, 但不能保证因为水或粉尘所导致的故障发生。XPT设计概念主要是在恶劣环境之下也可正常工作。

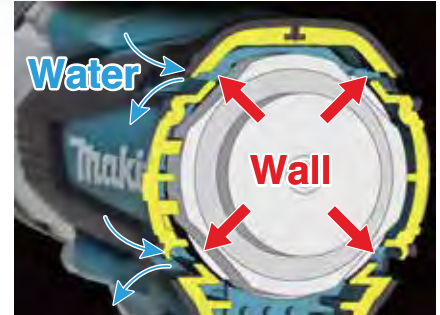

Because the walls are installed inside the vents, water and dust cannot enter easily.
Terdapat komponen elektronik yang dilapisi untuk menyekat kemasukan titisan debu dan air.
有包覆电子零组件阻隔粉尘、水滴入侵。

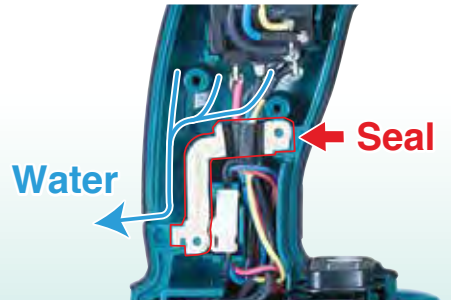

Moreover, even if water enters, it is discharged outside.
Sekiranya air masuk, ia dibuang ke luar.
若有水入侵时, 也被排出外部。

AWS

Auto - start Wireless System

Sistem permulaan wayarles automatik
无线自动启动系统



Connects to Compatible Vacuum Cleaners with Bluetooth

Sambungan tanpa wayar dengan pembersih vakum yang serasi dengan Bluetooth 通过蓝牙连接到兼容的吸尘器



WUT01 wireless unit

Enables wireless connection of Makita AWS™ capable tools with AWS™ Vacuum Cleaners

Untuk sambungan tanpa wayar alat kuasa AWS™ Makita dengan pembersih vacuum AWS™
Makita AWS™ 工具与AWS™ 吸尘器无线连接



Part No. 199393-1

WUT02 wireless unit adapter

Enables wireless connection of Makita AWS™ capable tools with most AC vacuum cleaner with auto start/ stop functions

Sambungan tanpa wayar alat kuasa AWS™ Makita dengan pembersih vakum AC yang berfungsi permulaan/ berhenti automatik
无线连接具有Makita AWS™ 功能的电动工具与具有自动启动/停止功能的AC吸尘器



Part No. 199809-6

AVT

ANTI VIBRATION TECHNOLOGY

Teknologi Anti Getaran
防振技术



- Vibration absorbing housing
- Active dynamic vibration absorber
- Damper spring

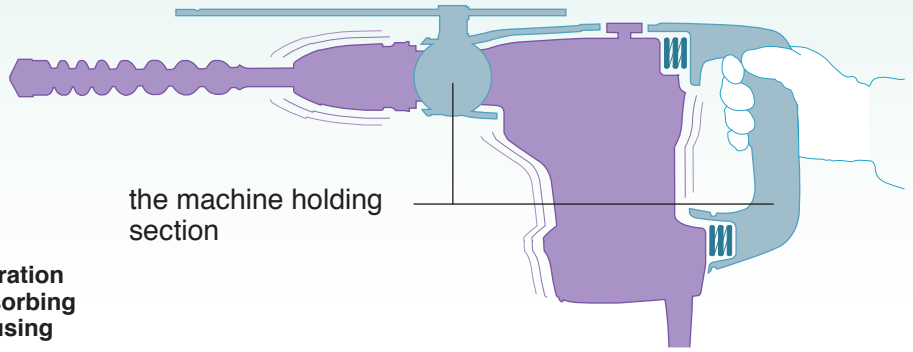

the machine holding section

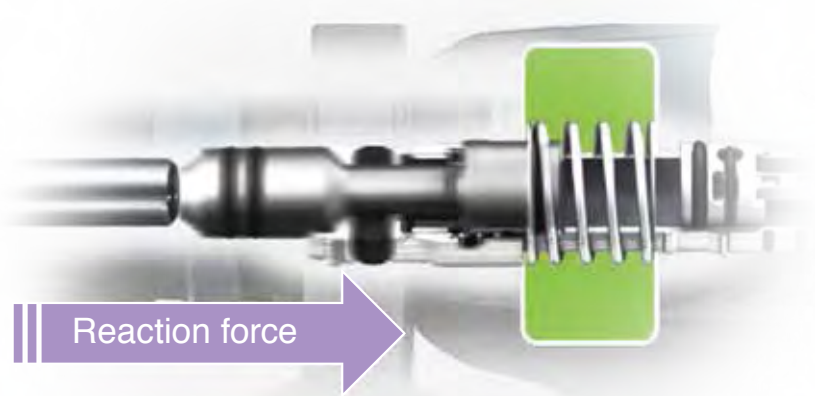
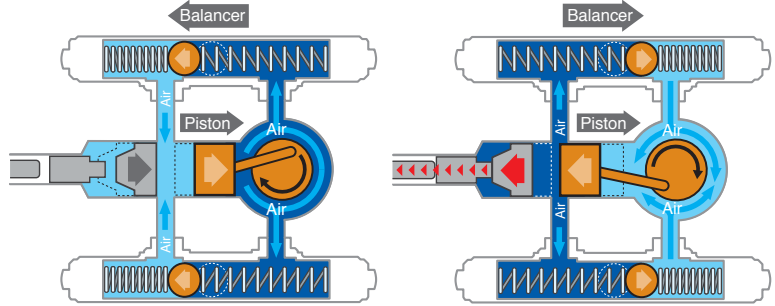

SOFT NO LOAD

Getaran rendah tanpa beban
无负载时低振动

During no-load



Suppression of motor speed

Penindasan kelajuan motor 电机转速的抑制

- reduces vibration of tool body when idling, accordingly decreases the amount of vibration to operator's hands during a day's operation
mengurangkan getaran badan alat ketika melahu, dengan itu mengurangkan jumlah getaran ke tangan pengendali semasa operasi sehari 减少空转时工具主体的振动, 从而减少一天操作中操作者手部的振动量
- minimizes deflection of bit tip from aiming point when starting chipping
meminimumkan pesongan bit tip dari titik sasaran apabila memulakan kerepotan 开始切屑时, 将刀尖从瞄准点的偏移减至最小

During no-load

Under load

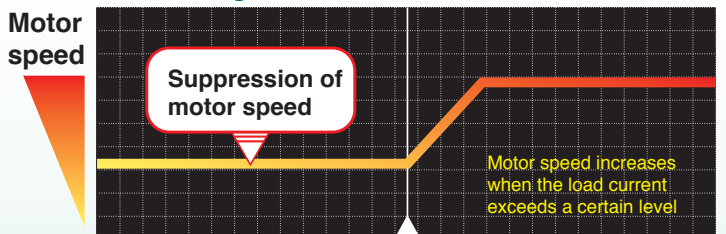

when starting chipping

Equipped with automatic speed control

Dilengkapi dengan kawalan laju automatik 设置自动速度控制功能



Automatically changes the cutting speed according to load conditions for an optimum operation

Fungsi pertukaran kelajuan automatik 自动变速功能

- On light duty: high-speed rotation mode
- On heavy duty: high torque mode
- Pada tugas ringan: mod putaran berkelajuan tinggi
- Pada tugas berat: mod torq tinggi
- 轻载: 高速旋转模式
- 重载: 高扭矩模式

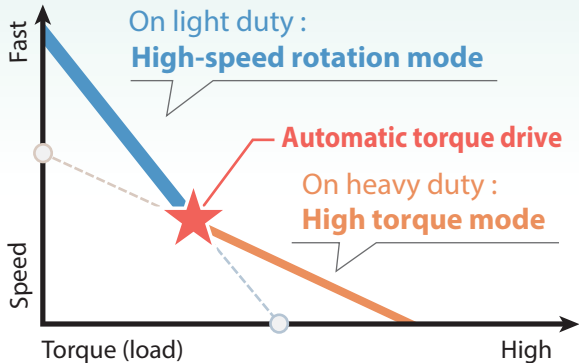

Smart function to minimize the danger of kick-back

Fungsi pintar untuk mengurangkan risiko kick-back 智慧型功能可减少反冲之危



Shuts down the tool to protect the user, if the rotation speed suddenly slows down

Jika kelajuan putaran tiba-tiba dikurangkan, alat akan dimatikan secara automatik untuk melindungi pengguna

若旋转速度突然降低, 工具将自动关闭以保护使用者

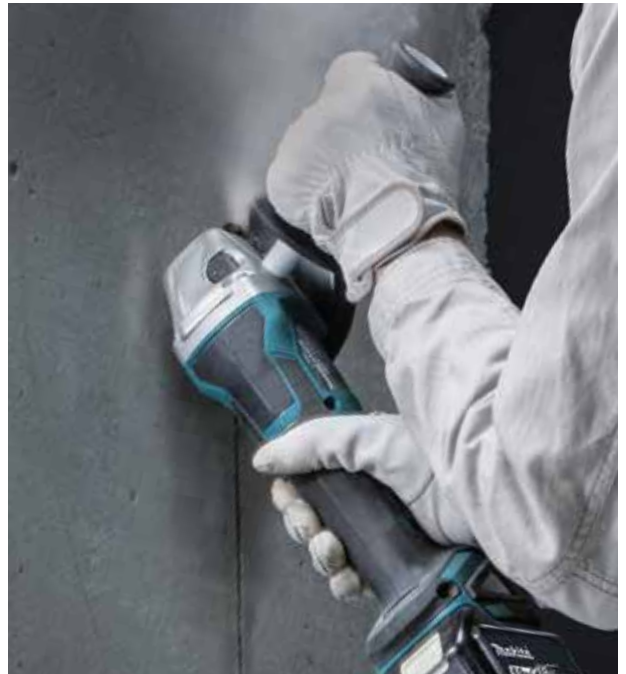
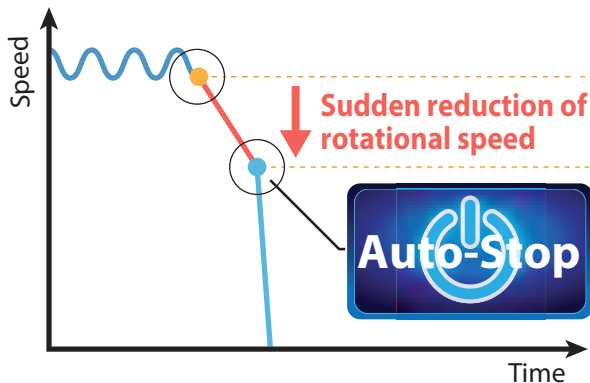

Electric brake

Brek elektrik 电子自动刹车

Electric brake is activated after the tool is switched off

Brek elektrik diaktifkan selepas alat dimatikan

电子自动刹车在工具关闭后被启动

Large switch lever

Tuas suis yang besar 大开关杆

with lock-off function (without lock-on function)

Lock-off function prevents the switch lever from being accidentally pulled

dengan fungsi mengunci

menghalang tuas suis daripada ditarik secara tidak sengaja

锁定功能可防止开关杆被意外拉动

Anti-restart function

Fungsi anti-restart 防止意外重启功能

The motor does not start up if battery is inserted when the switch slid to "on".

Selepas memuatkan bateri, motor tidak bermula jika suis ditetapkan ke kedudukan "ON"

装入电池后, 若开关设于「开启」位置时, 马达不会启动



Electric brake is activated after the tool is switched off

Brek elektrik diaktifkan selepas alat dimatikan

电子自动刹车在工具关闭后被启动





TO SUPPRESS VIBRATION TO OPERATOR

Menahan Getaran 在操作时能抑止震动

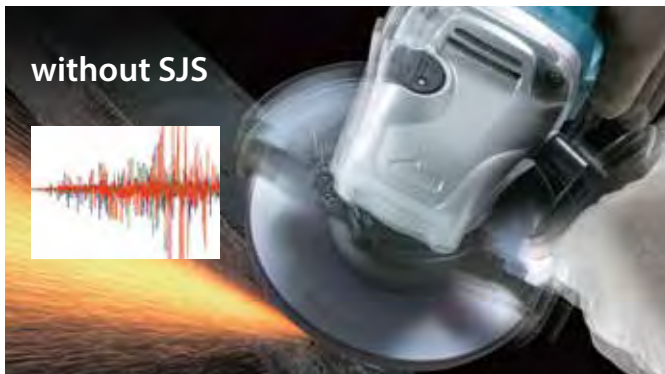

Structure of Super Joint System II

Struktur SJS generasi kedua 第二代 SJS 的结构

Leaf spring absorbs vibration and relieves shock during operation.

Leaf spring menyerap getaran dan mengurangkan kesan hentaman semasa operasi 在运行过程中，弹簧片吸收振动并减轻冲击



Absorption mechanism of vibration

Mekanisme penyerapan getaran 振动的吸收机能

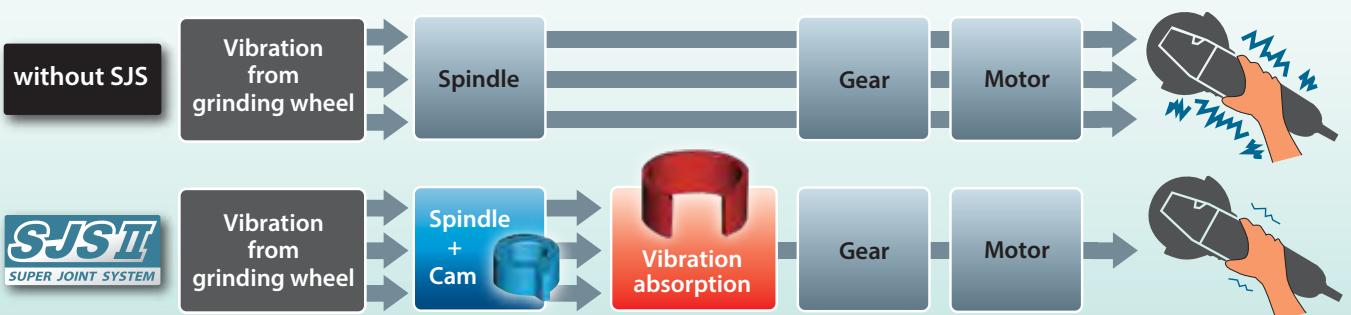

Automatic Self-cleaning Filtration System achieved by two filter units

Sistem Penapis Penyucian Automatik 自动清洗过滤系统

Constantly high suction power throughout operation because dust is removed from Prefilters every 10 seconds during operation

Kuasa penyedut yang berterusan sepanjang operasi kerana habuk dikeluarkan dari penapis setiap 10 saat semasa operasi
在整个运行过程中吸力保持在较高的水平，因为在运行过程中，每10秒就会从过滤器中除去灰尘

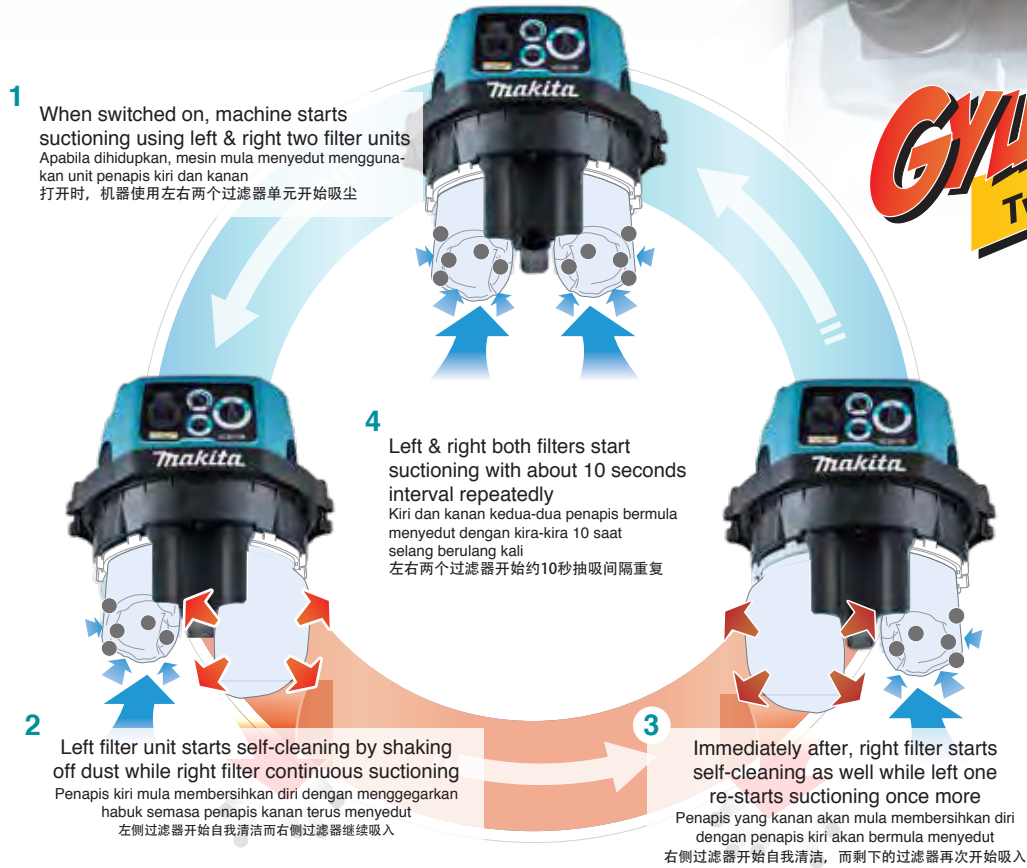

Automatic self-cleaning filter (VC1310L, VC2510L, VC3210L)

Sistem Penapis Penyucian Automatik 自动清洗过滤系统

obtained by Triple filter structure composed of: Powder filter + Damper + Prefilter

Kuasa penyedutan yang berterusan sepanjang operasi kerana habuk dikeluarkan dari Prefilters setiap 10 saat semasa operasi
由三重过滤器结构得到：粉末过滤器+阻尼器+预过滤器

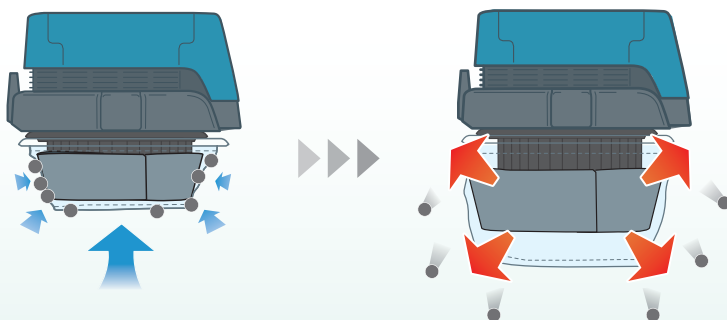

When the power is switched on, Prefilter collapses into itself to compress Damper, and fits closely over Damper and Powder filter.

Apabila kuasa dihidupkan, Prefilter runtuh ke dalamnya untuk memampatkan Damper, dan sesuai dengan penapis Damper dan Serbuk.
当接通电源时，Prefilter会自行折叠以压缩阻尼器，并紧密贴合阻尼器和粉末过滤器。

When the power is switched off, Damper expands back to its original size and shakes off dust from Prefilter automatically with its expanding power.

Apabila kuasa dimatikan, Damper mengembang kembali ke saiz asalnya dan mengelakkan habuk dari Prefilter secara automatik dengan kuasa yang berkembang.
当电源关闭时，阻尼器膨胀回到其原始尺寸，并通过扩展的功率自动将Prefilter的灰尘抖落。



DEEP CUTTING

Pemotongan dalam 深层切割

DXT

Deep and Exact Cutting Technology

Teknologi Pemotongan Ketepatan Dalam
深层精准切割技术

3-Stage reduction gear unit and Movable rear blade guard provide larger capacities of cutting Crown molding and Baseboard (Skirt board)

Peranti gear pengurangan tiga peringkat dan tutup belakang bilah gergaji boleh alih untuk pemotongan mudah diagonal garisan siling dan garis sudut (panel dinding) 三级减速齿轮装置及活动的后锯片护罩，方便斜切天花板线和墙角线(护壁板)

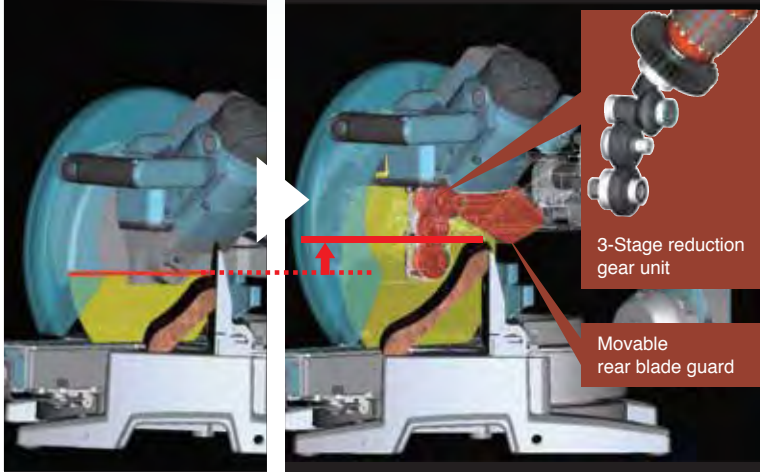

Capable of diagonal cutting up to **203mm (8")** crown molding



Capable of vertical cutting up to **165mm (6-1/2")** baseboard (skirt board)



EXACT CUTTING

Pemotongan ketepatan 精准切割

Double sliding mechanism

Teknologi pemotongan ketepatan dalam 双重滑动结构

Makita advantages obtained by using 4 short steel poles instead of 2 long poles are;

- Vibration-free, precise and exact cutting
- Compact tool design for jobsite portability

Gantikan 4 paip keluli panjang dengan 4 paip keluli pendek, supaya produk Makita mempunyai kelebihan berikut

- Bebas getaran, pemotongan tepat
- Reka bentuk alat padat untuk kemudahan medan

以4支短钢管取代2支长钢管，令牧田产品有以下优势之处

- 无振动，精确切割
- 紧凑的工具设计可实现现场便携性

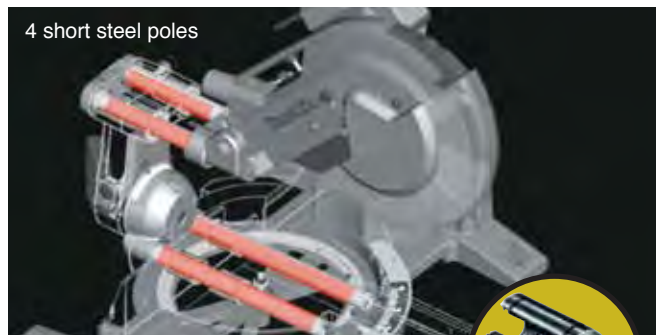

6 linear ball bearings are used to support the 4 poles for smooth and precise sliding cut.



Double sliding guide fence

Teknologi pemotongan ketepatan dalam 双重滑动引导栅

The upper and the lower sections slide independently for added convenience; each upper fence slides outwards for bevel cut, and each lower fence slide inwards to securely hold small workpiece for precise and exact cutting

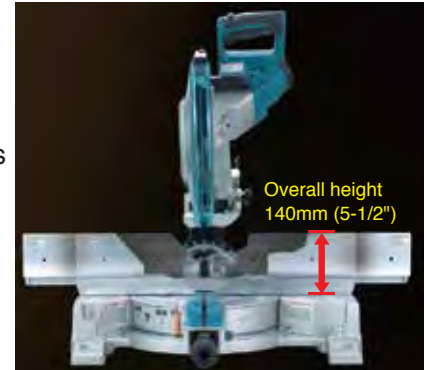

Bahagian atas dan bawah meluncur secara berasingan untuk kemudahan tambahan, grid panduan atas boleh meluncur ke luar pada sudut serong untuk dipotong, dan grid panduan bawah dapat meluncur ke dalam untuk memegang bahan-bahan kecil untuk memotong tepat

上下部分独立滑动以增加便利；上部引导栅能向外滑动斜角切割，而下部引导栅能向内滑动以牢牢地固定小材料，以进行精确的切割



Quick and accurate miter angle lock

Kunci sudut miter yang cepat dan tepat
快速准确的斜接角度锁定

- Miter angle can be locked/unlocked simply by turning the knob 90 degrees.
- With positive stops at 0, 15, 22.5, 31.6, 45 degrees



MAKPAC POWER SOURCE KIT

Set Bateri MAKPAC | MAKPAC锂电池套装

XGT 40Vmax **18V LITHIUM-ION**

- 1x Adapter ADP10 (191C11-5)
Penyesuaian 适配器
- 1x Fast Charger DC40RA (191E08-6)
Pengecas Pantas 快速充电器
- 1x 2.5Ah Battery BL4025 (191B36-3)
1x 6.0Ah Battery BL1860B (197422-4)
Bateri 锂电池

Makpac Connector Box Type 1 (821549-5)
Kotak Sambungan Makpac 工具连接箱

BASIC
40Vmax 2.5Ah + 18V 6.0Ah

PSKG1
(191T63-8)

XGT 40Vmax **18V LITHIUM-ION**

- 1x Fast Charger DC40RA (191E08-6)
Pengecas Pantas 快速充电器
- 2x 2.5Ah Battery BL4025 (191B36-3)
Bateri 锂电池

Makpac Connector Box Type 1 (821549-5)
Kotak Sambungan Makpac 工具连接箱

POWER
40Vmax 2.5Ah

MKP1G001
(191J86-6)

XGT 40Vmax **18V LITHIUM-ION**

- 1x Fast Charger DC40RA (191E08-6)
Pengecas Pantas 快速充电器
- 1x 4.0Ah Battery BL4040 (191B26-6)
Bateri 锂电池

BASIC
40Vmax 4.0Ah

PSKG0
(191J70-1)

XGT 40Vmax **18V LITHIUM-ION**

- 1x Fast Charger DC40RA (191E08-6)
Pengecas Pantas 快速充电器
- 4x 4.0Ah Battery BL4040 (191B26-6)
Bateri 锂电池

Makpac Connector Box Type 1 (821549-5)
Kotak Sambungan Makpac 工具连接箱

POWER
40Vmax 4.0Ah

MKP1G002
(191K02-4)

XGT 40Vmax **18V LITHIUM-ION**

- 1x Two Port Multi Fast Charger DC40RB (191N14-5)
Pengecas Pantas Dua Port 两端快速充电器
- 2x 5.0Ah Battery BL4050F (-)
Bateri 锂电池

Makpac Connector Box Type 3 (821551-9)
Kotak Sambungan Makpac 工具连接箱

ADVANCED
40Vmax 5.0Ah

PSKG3
(191U20-2)

XGT 40Vmax **18V LITHIUM-ION**

- 1x Two Port Multi Fast Charger DC40RB (191N14-5)
Pengecas Pantas Dua Port 两端快速充电器
- 4x 5.0Ah Battery BL4050F (-)
Bateri 锂电池

Makpac Connector Box Type 3 (821551-9)
Kotak Sambungan Makpac 工具连接箱

ULTIMATE
40Vmax 5.0Ah

PSKG3
(191U48-0)

18V LITHIUM-ION
18V Litium-ion | 18V锂离子

- 1x Rapid Charger DC18RC (195586-8)
Pengecas Pantas 快速充电器
- 1x 3.0Ah Battery BL1830B (197600-6)
Bateri 锂电池

Makpac Connector Box Type 1 (821549-5)
Kotak Sambungan Makpac 工具连接箱

BASIC
18V 3.0Ah

MKP1RF181
(197973-7)

18V LITHIUM-ION
18V Litium-ion | 18V锂离子

- 1x Rapid Charger DC18RC (195586-8)
Pengecas Pantas 快速充电器
- 3x 3.0Ah Battery BL1830B (197600-6)
Bateri 锂电池

Makpac Connector Box Type 1 (821549-5)
Kotak Sambungan Makpac 工具连接箱

POWER
18V 3.0Ah

MKP1RF182
(197974-5)

18V LITHIUM-ION
18V Litium-ion | 18V锂离子

- 1x Rapid Charger DC18RC (195586-8)
Pengecas Pantas 快速充电器
- 2x 4.0Ah Battery BL1840B (197265-4)
Bateri 锂电池

Makpac Connector Box Type 1 (821549-5)
Kotak Sambungan Makpac 工具连接箱

POWER
18V 4.0Ah

MKP1RM182
(191L71-1)

18V LITHIUM-ION
18V Litium-ion | 18V锂离子

- 1x Rapid Charger DC18RC (195586-8)
Pengecas Pantas 快速充电器
- 1x 5.0Ah Battery BL1850B (197282-4)
Bateri 锂电池

Makpac Connector Box Type 1 (821549-5)
Kotak Sambungan Makpac 工具连接箱

BASIC
18V 5.0Ah

MKP1RT181
(197801-6)

18V LITHIUM-ION
18V Litium-ion | 18V锂离子

- 1x Rapid Charger DC18RC (195586-8)
Pengecas Pantas 快速充电器
- 2x 5.0Ah Battery BL1850B (197282-4)
Bateri 锂电池

Makpac Connector Box Type 1 (821549-5)
Kotak Sambungan Makpac 工具连接箱

POWER
18V 5.0Ah

MKP1RT182
(197803-2)

18V LITHIUM-ION
18V Litium-ion | 18V锂离子

- 1x Two Port Multi Rapid Charger DC18RD (196934-4)
Pengecas Pantas Dua Port 两端快速充电器
- 2x 5.0Ah Battery BL1850B (197282-4)
Bateri 锂电池

Makpac Connector Box Type 3 (821551-9)
Kotak Sambungan Makpac 工具连接箱

ADVANCED
18V 5.0Ah

MKP3PT182
(198182-1)

18V LITHIUM-ION
18V Litium-ion | 18V锂离子

- 1x Two Port Multi Rapid Charger DC18RD (196934-4)
Pengecas Pantas Dua Port 两端快速充电器
- 4x 5.0Ah Battery BL1850B (197282-4)
Bateri 锂电池

Makpac Connector Box Type 3 (821551-9)
Kotak Sambungan Makpac 工具连接箱

ULTIMATE
18V 5.0Ah

MKP3PT184
(197627-6)

18V LITHIUM-ION
18V Litium-ion | 18V锂离子

- 1x Rapid Charger DC18RC (195586-8)
Pengecas Pantas 快速充电器
- 2x 6.0Ah Battery BL1860B (197422-4)
Bateri 锂电池

Makpac Connector Box Type 1 (821549-5)
Kotak Sambungan Makpac 工具连接箱

ADVANCED
18V 6.0Ah

MKP1RG182
(198119-8)

18V LITHIUM-ION
18V Litium-ion | 18V锂离子

- 1x Two Port Multi Rapid Charger DC18RD (196934-4)
Pengecas Pantas Dua Port 两端快速充电器
- 4x 6.0Ah Battery BL1860B (197422-4)
Bateri 锂电池

Makpac Connector Box Type 3 (821551-9)
Kotak Sambungan Makpac 工具连接箱

ULTIMATE
18V 6.0Ah

MKP3PG184
(198095-6)

12Vmax LITHIUM-ION
12V Litium-ion | 12V锂离子

- 1x Speed Charger DC10SB (197346-4)
Pengecas Pantas 快速充电器
- 1x 1.5Ah Battery BL1016 (197393-5)
Bateri 锂电池

Makpac Connector Box Type 1 (821549-5)
Kotak Sambungan Makpac 工具连接箱

BASIC
12Vmax 1.5Ah

MKP1SY122
(197654-3)

12Vmax LITHIUM-ION
12V Litium-ion | 12V锂离子

- 1x Speed Charger DC10SB (197346-4)
Pengecas Pantas 快速充电器
- 2x 2.0Ah Battery BL1021B (197396-9)
Bateri 锂电池

Makpac Connector Box Type 1 (821549-5)
Kotak Sambungan Makpac 工具连接箱

POWER
12Vmax 2.0Ah

MKP1SA122
(197664-0)

12Vmax LITHIUM-ION
12V Litium-ion | 12V锂离子

- 1x Speed Charger DC10SB (197346-4)
Pengecas Pantas 快速充电器
- 1x 4.0Ah Battery BL1041B (197406-2)
Bateri 锂电池

Makpac Connector Box Type 1 (821549-5)
Kotak Sambungan Makpac 工具连接箱

ULTIMATE
12Vmax 4.0Ah

MKP1SM122
(197640-4)

Comfortable For Long Hours Operation

Selesa untuk operasi masa panjang 舒适的长时间操作

Portable Power Pack

Bekalan kuasa mudah alih 背式电池扩充座

PDC1200



Capacity Kapasiti 能力	33.5Ah
Energy Capacity Keupayaan Tenaga 能量容量	1,206Wh
Power Supply Cord Kord Bekalan Kuasa 电源线	Battery Side: 1.1 m (3.6 ft) Adapter Side: 0.6 m (2.0 ft)



Quickly removable harness can be attached/ removed from the main unit with a single action
Tali sandang bahu cepat dilepaskan, ia boleh dipasang atau dikeluarkan dari unit utama dengan hanya satu operasi
快速拆卸式背带, 只需一次操作即可将其安装在主机上或从主机上卸下



Reflectors keep operator visible from a distance even in the dark
Reflektor meningkatkan keselamatan kerja malam
提高夜间作业安全性的反射材料



Charger DC4001
• Equipped with a fan to cool down the charging circuit board
• Removable AC inlet plug
Pengecap DC4001 dilengkapi dengan kipas untuk menyejukkan papan litar pengecasan dan soket kuasa AC yang boleh ditanggalkan
充电器 DC4001 配备风扇冷却充电电路板, 可拆卸交流电源插座

IPX4
Water Resistance

Cord length 1.1m
Panjang kord 电源线长度



PDC1200A01 included
- 18Vx2 Adapter (Part No. 191J51-5)
- DC4001 Battery Charger Set (Part No. 191L01-2)
- Harness Assembly (127668-8)

Optional for
PDC1200 & PDC01
40Vmax Adapter Set
(191N62-4)

Portable Power Pack

Bekalan kuasa mudah alih 背式电池扩充座

PDC01



Capacity Kapasiti 能力	18V x2 : 12 Ah (with BL1860B x4) 18V : 24 Ah (with BL1860B x4)
Energy Capacity Keupayaan Tenaga 能量容量	432Wh (BL1860Bx4)
Power Supply Cord Kord Bekalan Kuasa 电源线	1.7 m (5.6 ft)



IPX4
Water Resistance

Battery cover Protection from water and dust
Penutup bateri untuk perlindungan daripada air dan habuk
防水防尘电池盖

Comfortable, adjustable backpack harness
Tali sandang bahu yang selesa dan boleh laras
舒适可调节的背带



TWO VARIATIONS



1 PDC01 (191A62-6) included
- 18V Adapter (Part No. 191J50-7)
- 18Vx2 Adapter (Part No. 191J51-5)
- Harness Assembly



2 PDC01 (191A67-6) included
- 18Vx2 Adapter (Part No. 191J51-5)
- Harness Assembly

Lightweight
Ringan 轻量

7kg

with 4x BL1850B
5.0Ah Battery

Cord length 1.7m
Panjang kord 电源线长度

Fuel gauge for each battery indicates the battery status by two green lights
Penunjuk tahap bateri menunjukkan status bateri dengan dua lampu hijau
每个电池的电量计, 通过两个绿色指示灯指示电池状态

Main power switch With auto-off function
Suis kuasa utama dengan fungsi auto-off
主电源开关具有自动关机功能

Convenience for every OCCASION

Sesuai Untuk Pelbagai Kegunaan/ 适用于任何场合

Heat-resistant Temperature
0 ~ 60°c
Suhu tahan haba 0 ~ 60°c
保冷度 0 ~ 60°c

Maintaining COOL Temperature
Mengekalkan suhu sejuk
冷藏专用

MAKPAC Cool Box

Kotak Sejuk MAKPAC/ 层叠式冷藏箱

20mm thickness formed polystyrene, sealing strips are placed around the mating surface of lid and box

Dibuat dari ketebalan 20mm polistirena dan dipasang dengan jalur pengedap di sekeliling permukaan penutup dan kotak
箱体壁厚为20mm, 盖子和箱子的连接处配备密封条



11L

500mL x 10 | 2L x 2

(Type 3)

Part No. 198254-2

- Dimensions
Dimensi | 体积 (L x W x H)
295 x 395 x 210mm (11-5/8" x 15-1/2" x 8-1/4")
- Net weight
Berat bersih | 净重
2.9kg (6.3lbs)



• Both type can be equipped with a shoulder strap

Kedua-dua jenis Makpac boleh dipasang dengan tali pemegang bahu
两种型号皆可配备肩带



Come with Shoulder belt
Dilengkapkan dengan tali pemegang bahu | 配备背负肩带



18L

500mL x 20 | 2L x 4

(Type 4)

Part No. 198253-4

- Dimensions
Dimensi | 体积 (L x W x H)
295 x 395 x 315mm (11-5/8" x 15-1/2" x 12-3/8")
- Net weight
Berat bersih | 净重
3.7kg (8.1lbs)



Type 1
Part No. 821549-5

Type 2
Part No. 821550-0

Type 3
Part No. 821551-8

Type 4
Part No. 821552-6

• MAKPAC Box
Kotak Makpac
工具连接箱



Part No. TR00000002
• Able to stack on MAKPAC trolley for easy loading (option)

Boleh ditambah dan disambung atas troli Makpac untuk memudahkan kerja pengalihan kotak Makpac (pilihan)
Makita工具箱可以添加并连接到拖运车, 以方便搬运(选择性)



18V
Lithium-ion

LXT

Teknologi Ekstrim Lithium-ion
锂离子技术

CORDLESS COMBO KIT

Pakej kombo peralatan tanpa kord 充电式工具套装

18V
LITHIUM-ION
18V Lithium-ion | 18V 锂离子

CORDLESS COMBO KIT
Pakej kombo peralatan tanpa kord 充电式工具套装

DLX2248PT1



- 2** 1x DCL181F Cordless Cleaner
Pembersih Vakum Tanpa Kord
充电式便携吸尘器
1x 5.0Ah Battery (BL1850B)
Bateri 5.0Ah (BL1850B)
5.0Ah 电池 (BL1850B)



- 3** 1x Makita Tool Bag
Beg Alat Makita
Makita 工具袋



BL
MOTOR

Motor tanpa berus 无碳刷马达

- 1** 1x DVC260Z
Cordless Backpack Vacuum Cleaner
Pembersih Vakum Beg Galas Tanpa Kord
充电式背负吸尘器
2x 5.0Ah Battery (BL1850B)
Bateri 5.0Ah (BL1850B)
5.0Ah 电池 (BL1850B)



- 4** 1x Two Port Multi
Rapid Charger (DC18RD)
Pengecas Pantas Dua Port (DC18RD)
两端快速充电器 (DC18RD)

- 1x Round Brush (198877-6)
Berus Bulat 圆刷
1x Flexible Rubber Nozzle (197900-4)
Muncung Getah Fleksibel 弹性吸嘴
1x Nozzle Assembly (199037-9)
Komponen Muncung 吸嘴组件
1x Corner Nozzle (198918-8)
Muncung Sudut 角落吸嘴
1x Flexible Hose (198867-9)
Hos Fleksibel 软管



10pcs Paper Dust Bag
(197902-0)
Beg Habuk Kertas
纸制集尘袋

10pcs Filter
(198914-6)
Penapis 尘袋



CORDLESS COMBO KIT

Pakej kombo peralatan tanpa kord 充电式工具套装

DLX3131TX2



18V Litium-ion | 18V 锂离子



Motor tanpa berus 无碳刷马达



EXTREME PROTECTION TECHNOLOGY
Teknologi Perlindungan Ekstrem
防尘防水滴技术



- 1x DHR242 24mm (15/16")
Cordless Combination Hammer
Tukul Kombinasi Tanpa Kord 充电式冲击电钻电锤
1x 5.0Ah Battery (BL1850B)
Bateri 5.0Ah (BL1850B) 5.0Ah 电池 (BL1850B)



Motor tanpa berus 无碳刷马达



EXTREME PROTECTION TECHNOLOGY
Teknologi Perlindungan Ekstrem
防尘防水滴技术



- 1x DTW285 12.7mm (1/2")
Cordless Impact Wrench
Perengkuh Impak Tanpa Kord 充电式冲击套筒扳手
1x 5.0Ah Battery (BL1850B)
Bateri 5.0Ah (BL1850B) 5.0Ah 电池 (BL1850B)



Motor tanpa berus 无碳刷马达



EXTREME PROTECTION TECHNOLOGY
Teknologi Perlindungan Ekstrem
防尘防水滴技术



- 1x DGA404 100mm (4")
Cordless Angle Grinder
Pengisar Sudut Tanpa Kord 角向磨光机
1x 5.0Ah Battery (BL1850B)
Bateri 5.0Ah (BL1850B) 5.0Ah 电池 (BL1850B)
1x Depressed Centre Wheel (A-80852)
Cakera Abrasif 磨片



- 1x Two Port Multi
Rapid Charger (DC18RD)
Pengecap Pantas Dua Port (DC18RD)
两端快速充电器 (DC18RD)



- 1x Makita Tool Bag
(831271-6)
Beg Alat Makita
Makita 工具袋

CORDLESS COMBO KIT

Pakej kombo peralatan tanpa kord 充电式工具套装

DLX2218X



18V Litium-ion | 18V 锂离子



- 1x Rapid Charger (DC18RC)
Pengecap Pantas (DC18RC)
快速充电器 (DC18RC)



- 1x DHR165 16mm (5/8")
Cordless Rotary Hammer
Tukul Berputar Tanpa Kord 充电式电锤
1x 3.0Ah Battery (BL1830B)
Bateri 3.0Ah (BL1830B) 3.0Ah 电池 (BL1830B)



EXTREME PROTECTION TECHNOLOGY
Teknologi Perlindungan Ekstrem
防尘防水滴技术

- 1x DTW190 12.7mm (1/2")
Cordless Impact Wrench
Perengkuh Impak Tanpa Kord
充电式冲击套筒扳手
1x 3.0Ah Battery (BL1830B)
Bateri 3.0Ah (BL1830B) 3.0Ah 电池 (BL1830B)



- 1x Makita Aluminium
Suitcase
(831271-6)
Beg Bimbit Aluminium Makita
Makita 铝合金工具箱

CORDLESS COMBO KIT

Pakej kombo peralatan tanpa kord 充电式工具套装

DLX2220



18V Litium-ion | 18V 锂离子



- 1x Rapid Charger (DC18RC)
Pengecap Pantas (DC18RC)
快速充电器 (DC18RC)

- 1x DTD155 Cordless
Impact Driver
Pemutar Skru Impak Tanpa Kord
充电式冲击螺丝起子机
1x 3.0Ah Battery (BL1830B)
Bateri 3.0Ah (BL1830B) 3.0Ah 电池 (BL1830B)



Motor tanpa berus 无碳刷马达



EXTREME PROTECTION TECHNOLOGY
Teknologi Perlindungan Ekstrem
防尘防水滴技术



- 1x DDF483 13mm (1/2")
Cordless Driver Drill
Gerudi Pemutar Skru Tanpa Kord
充电式螺丝起子电钻
1x 3.0Ah Battery (BL1830B)
Bateri 3.0Ah (BL1830B) 3.0Ah 电池 (BL1830B)



Motor tanpa berus 无碳刷马达



EXTREME PROTECTION TECHNOLOGY
Teknologi Perlindungan Ekstrem
防尘防水滴技术



- 1x Makita Tool Bag
Beg Alat Makita
Makita 工具袋

CORDLESS COMBO KIT

Pakej kombo peralatan tanpa kord 充电式工具套装

DLX2424JX1**NEW**
BARU | 新

- 1 **1x Rapid Charger (DC18RC)**
Pengecas Pantas (DC18RC)
快速充电器 (DC18RC)



18V Lithium-Ion | 18V 锂离子电池



- 2 **1x DMP180**
Cordless Inflator
Inflator Tanpa Kord 充电式打气机
1x 5.0Ah Battery (BL1850B)
Bateri 5.0Ah (BL1850B)
5.0Ah 电池 (BL1850B)



- 3 **1x DTW300**
Cordless Impact Wrench
Perengkuh Impak Tanpa Kord 充电式冲击套筒扳手
1x 5.0Ah Battery (BL1850B)
Bateri 5.0Ah (BL1850B) 5.0Ah 电池 (BL1850B)



- 4 **Makpac Connector Box**
Kotak Sambungan Makpac 工具连接箱

CORDLESS COMBO KIT

Pakej kombo peralatan tanpa kord 充电式工具套装

DLX2417JX1**NEW**
BARU | 新

- 1 **1x Rapid Charger (DC18RC)**
Pengecas Pantas (DC18RC)
快速充电器 (DC18RC)



18V Lithium-Ion | 18V 锂离子电池



- 2 **1x DHP484**
Cordless Hammer Driver Drill
Tukul Pemutar Skru Bergerudi 冲击螺丝起子电钻
1x 3.0Ah Battery (BL1830B)
Bateri 3.0Ah (BL1830B)
3.0Ah 电池 (BL1830B)



- 3 **1x DTD156**
Cordless Impact Driver
Pemutar Skru Impak 冲击螺丝起子机
1x 3.0Ah Battery (BL1830B)
Bateri 3.0Ah (BL1830B) 3.0Ah 电池 (BL1830B)

- 4 **1x Double Ended Twist**
Torsion Screw Bit
Skrus Kilasan Pental Dua Mata
双头扭曲扭力螺丝批头
1x (+)(-) Bit
Mata Skru 螺丝批头



- 5 **Makpac Connector Box**
Kotak Sambungan Makpac 工具连接箱

CORDLESS COMBO KIT

Pakej kombo peralatan tanpa kord 充电式工具套装

DLX2414JX2**NEW**
BARU | 新

- 1 **1x Rapid Charger (DC18RC)**
Pengecas Pantas (DC18RC)
快速充电器 (DC18RC)



18V Lithium-Ion | 18V 锂离子电池



- 2 **1x DTD157**
Cordless Impact Driver
Pemutar Skru Impak 冲击螺丝起子机
1x 2.0Ah Battery (BL1820B)
Bateri 2.0Ah (BL1820B)
2.0Ah 电池 (BL1820B)



- 3 **1x DHP487**
Cordless Hammer Driver Drill
Tukul Pemutar Skru Bergerudi 冲击螺丝起子电钻
1x 2.0Ah Battery (BL1820B)
Bateri 2.0Ah (BL1820B) 2.0Ah 电池 (BL1820B)



- 4 **1x Double Ended Twist**
Torsion Screw Bit
Skrus Kilasan Pental Dua Mata
双头扭曲扭力螺丝批头
1x (+)(-) Bit
Mata Skru 螺丝批头



- 5 **Makpac Connector Box**
Kotak Sambungan Makpac 工具连接箱

CORDLESS COMBO KIT

Pakej kombo peralatan tanpa kord 充电式工具套装

DLX2423JX2**NEW**
BARU | 新

- 1 **1x Rapid Charger (DC18RC)**
Pengecas Pantas (DC18RC)
快速充电器 (DC18RC)



18V Lithium-Ion | 18V 锂离子电池



- 2 **1x DTD157**
Cordless Impact Driver
Pemutar Skru Impak 冲击螺丝起子机
1x 2.0Ah Battery (BL1820B)
Bateri 2.0Ah (BL1820B)
2.0Ah 电池 (BL1820B)



- 3 **1x DDF487**
Cordless Driver Drill
Gerudi Pemutar Skru 螺丝起子电钻
1x 2.0Ah Battery (BL1820B)
Bateri 2.0Ah (BL1820B) 2.0Ah 电池 (BL1820B)



- 4 **1x Double Ended Twist**
Torsion Screw Bit
Skrus Kilasan Pental Dua Mata
双头扭曲扭力螺丝批头
1x (+)(-) Bit
Mata Skru 螺丝批头

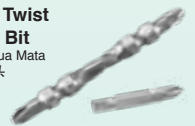

- 5 **Makpac Connector Box**
Kotak Sambungan Makpac 工具连接箱

CORDLESS COMBO KIT

Pakej kombo peralatan tanpa kord 充电式工具套装

DK0090SWX1

1 1x Standard Charger (DC18SD)
Pengecas Standard (DC18SD)
标准充电器 (DC18SD)

2 1x 1.5Ah Battery (BL1815N)
Bateri 1.5Ah (BL1815B)
1.5Ah 电池 (BL1815B)



1x Filter (443060-3)
Penapis 过滤器
1x Pre Filter (451208-3)
Penapis Depan 前置过滤器

3 1x DCL180 Cordless Cleaner (White)
Pembersih Vakum Tanpa Kord (Putih)
充电式便携吸尘器 (白)

1x Flexible Hose (198867-9)
Hos Fleksibel 软管
1x Round Brush (198877-6)
Berus Bulat 圆刷
1x Shelf Brush (198872-6)
Berus Rata 扁毛刷

4 1x DF001D 3.6V Cordless Screwdriver (Built-in Battery)
Pemutar Skru Tanpa Kord (Bateri terbina dalam)
充电式螺丝起子机 (内置电池)

5 1x ADP07 Adapter for USB
Pengecas
充电器



6 1x Makita Tool Bag (831271-6)
Beg Alat Makita
Makita 工具袋

CORDLESS COMBO KIT

Pakej kombo peralatan tanpa kord 充电式工具套装

DK0089WX1

1 1x Standard Charger (DC10WD)
Pengecas Standard (DC10WD)
标准充电器 (DC10WD)

2 1x 1.5Ah Battery (BL1016)
Bateri 1.5Ah (BL1016)
1.5Ah 电池 (BL1016)



5pcs Paper Filter (194506-1)
Penapis Kartas 纸制尘袋

3 1x CL107FD Cordless Cleaner (White)
Pembersih Vakum Tanpa Kord (Putih)
充电式便携吸尘器 (白)

1x Flexible Hose (198867-9)
Hos Fleksibel 软管
1x Round Brush (198877-6)
Berus Bulat 圆刷
1x Shelf Brush (198872-6)
Berus Rata 扁毛刷

4 1x DF001D 3.6V Cordless Screwdriver (Built-in Battery)
Pemutar Skru Tanpa Kord (Bateri terbina dalam)
充电式螺丝起子机 (内置电池)

5 1x ADP07 Adapter for USB
Pengecas
充电器



6 1x Makita Tool Bag (831271-6)
Beg Alat Makita
Makita 工具袋

CORDLESS COMBO KIT

Pakej kombo peralatan tanpa kord 充电式工具套装

CLX224

1 1x Standard Charger (DC10WD)
Pengecas Standard (DC10WD)
标准充电器 (DC10WD)



2 1x TD110D Cordless Impact Driver
Pemutar Skru Impak Tanpa Kord
充电式冲击螺丝起子机
1x 1.5Ah Battery (BL1016)
Bateri 1.5Ah (BL1016)
1.5Ah 电池 (BL1016)

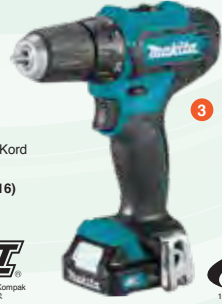

3 1x DF333D Cordless Driver Drill
Gerudi Pemutar Skru Tanpa Kord
充电式螺丝起子电钻
1x 1.5Ah Battery (BL1016)
Bateri 1.5Ah (BL1016)
1.5Ah 电池 (BL1016)



4 1x Makita Tool Bag
Beg Alat Makita
Makita 工具袋

CORDLESS COMBO KIT

Pakej kombo peralatan tanpa kord 充电式工具套装

CLX224X1

1 1x Standard Charger (DC10WD)
Pengecas Standard (DC10WD)
标准充电器 (DC10WD)



2 1x TD110D Cordless Impact Driver
Pemutar Skru Impak Tanpa Kord
充电式冲击螺丝起子机
1x 1.5Ah Battery (BL1016)
Bateri 1.5Ah (BL1016)
1.5Ah 电池 (BL1016)



3 1x DF333D Cordless Driver Drill
Gerudi Pemutar Skru Tanpa Kord
充电式螺丝起子电钻
1x 1.5Ah Battery (BL1016)
Bateri 1.5Ah (BL1016)
1.5Ah 电池 (BL1016)



4 1x Makita Aluminium Suitcase
Beg Bimbit Aluminium Makita
Makita 铝合金工具箱

CORDLESS COMBO KIT

Pakej kombo peralatan tanpa kord 充电式工具套装

CLX206AX2

1 1x Standard Charger (DC10WD)
Pengecas Standard (DC10WD)
标准充电器 (DC10WD)



2 1x TM30D Cordless Multi Tool
Mesin Pemotong Pelbagai Guna Tanpa Kord
充电式多功能切磨机
1x 2.0Ah Battery (BL1021B)
Bateri 2.0Ah (BL1021B)
2.0Ah 电池 (BL1021B)
1x Accessories Set
Set Aksesori 配件套装



3 1x DF331D Cordless Driver Drill
Gerudi Pemutar Skru Tanpa Kord
充电式螺丝起子电钻
1x 2.0Ah Battery (BL1021B)
Bateri 2.0Ah (BL1021B)
2.0Ah 电池 (BL1021B)
1x Phillips Bit
Mata Skru 螺丝批头



4 1x Makita Tool Bag (831253-8)
Beg Alat Makita
Makita 工具袋

XGT

40V Li-ion max

XGT X2 80Vmax

Rotary Hammer
HR006G



Demolition Hammer
HM002G



Rotary Hammer
HR005G



Demolition Hammer
HM001G



Combination Hammer
HR001G / HR002G /
HR003G / HR004G

Angle Grinder
GA003G / GA004G / GA005G / GA006G / GA007G / GA008G / GA011G /
GA012G / GA013G / GA014G / GA015G / GA016G / GA021G / GA022G /
GA023G / GA024G / GA025G / GA026G / GA027G / GA028G / GA029G /
GA030G / GA031G / GA032G / GA035G / GA036G / GA037G / GA038G



Slide Compound
Miter Saw
LS002G / LS003G

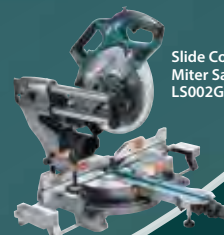

Rear Handle Saw
RS001G / RS002G



Circular Saw
HS003G / HS004G



Recipro Saw
JR001G



Multi Function
Power Head
UX01G



Cleaner
CL001G



Blower
UB001G

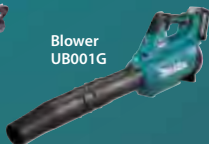

Fan
CF001G / CF002G



Flashlight
ML001G



LED Worklight
ML002G / ML003G



Driver Drill
DF001G / DF002G



Hammer Driver Drill
HP001G / HP002G



Impact Driver
TD001G



Impact Wrench
TW001G / TW004G / TW005G /
TW007G / TW008G



Angle Drill
DA001G / DA002G



Job Site Radio
MR001G / MR002G /
MR003G / MR004G



Brad Nailer
FN001G



Hedge Trimmer
UH004G / UH005G / UH006G /
UH007G / UH008G / UH009G

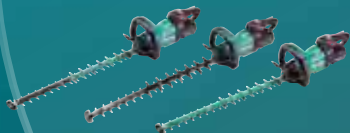

Earth Auger
DG001G



Grass Trimmer
UR002G / UR003G / UR006G /
UR007G / UR008G



High Power

Kuasa Tinggi 高马力

Durability

Ketahanan 超耐用

Digital Communication

Sistem Pintar 智能系统

Battery

BL4020 (2.0Ah) BL4025 (2.5Ah) BL4040 (4.0Ah) BL4050F (5.0Ah)



Charger

DC40RA DC40RB DC40RC

ADP10
Adapter for LXT Battery

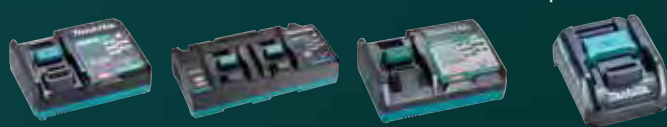



Li-ion Ah 5.0 4.0 2.5 2.0

*Compatible batteries

HM002GZ03

Price TBA

Cordless Demolition Hammer

Pemahat Tukul Tanpa Kord
充电式电动槌



*Recommended batteries 2.0Ah, 2.5Ah, 4.0Ah, 5.0Ah



- Anti-Vibration Technology (AVT) ensures extra-low vibration performance

Standard Equipment: Bull Point (A-80787), Bit Grease (194683-7), Side Handle, Cloth

• GZ03: Without Charger & Battery



Impact Energy Kekuatan Impak 单次最大锤击力	EPTA-Procedure 05/2009: 20.9J
Impacts Per Minute (IPM) Impak Per Minit 冲击数	950 - 1,900
Shank Diameter Diameter Shank 柄直径	18mm (11/16")
Dimensions (L x W x H) Dimensi 体积	574x146x324mm (22-5/8x5-3/4x12-3/4")
Net Weight Berat Bersih 净重	12.0 - 13.3kg (26.5 - 29.3lbs.)

Cordless Rotary Hammer

Tukul Putar Tanpa Kord 充电式电钻



Impact Energy
[EPTA-Procedure 05/2009]
Kekuatan Impak
单次最大锤击力

21.4
Joule

2
mode

Rotation + Hammering
penukulan dengan putaran
旋转并锤击

Hammering
penukulan sahaja
仅锤击

AWS Auto-start Wireless System

connects to compatible vacuum cleaner with Bluetooth.
The vacuum cleaner automatically runs while the switch is on.

Sambungkan ke pembersih vakum yang serasi melalui Bluetooth.
Pembersih vakum berfungsi secara automatik apabila suis dihidupkan.
通过蓝牙连接到兼容的吸尘器。
真空吸尘器在开关打开时自动运行。

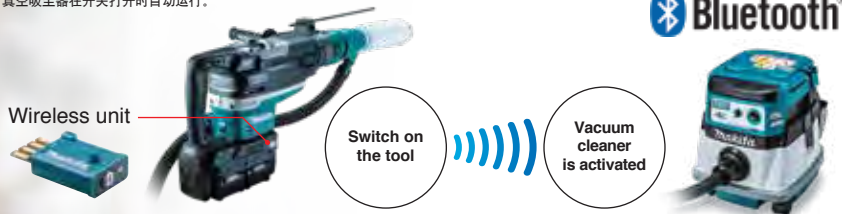

HR006GZ 52mm (2-1/16")

RM 8,002

Cordless Rotary Hammer

Tukul Putar Tanpa Kord
充电式电钻



*Recommended batteries 2.0Ah, 2.5Ah, 4.0Ah, 5.0Ah



- Powerful BL motor delivers 21.4J of impact energy to handle the most demanding applications

Standard Equipment: Side Handle, Side Grip, Depth Gauge, Bit Grease, Cloth

• GZ: Without Charger & Battery



Impact Energy Kekuatan Impak 单次最大锤击力	EPTA-Procedure 05/2009: 21.4J
Capacity Kapasiti 能力	Concrete (TCT Bit): 52mm (2-1/16") Concrete (Core Bit): 160mm (6-5/16")
Impacts Per Minute (IPM) Impak Per Minit 冲击数	1,100 - 2,250
No Load Speed (RPM) Kelajuan Tanpa Beban 回转数	150 - 310
Dimensions (L x W x H) Dimensi 体积	610x140x337mm (24x5-1/2x13-1/4")
Net Weight Berat Bersih 净重	12.9 - 14.3kg (28.4 - 31.5lbs.)

* All list price shown are for reference only (exclude SST).

* Semua harga yang ditunjukkan adalah untuk rujukan sahaja (tidak termasuk SST). 所有显示的建议零售价仅供参考 (不包括SST)。

Cordless Impact Driver
LED Flashlight
Vacuum Cleaner
Drilling / Fastening
Impact Drilling / Demolition
Cutting
Grinding / Sanding
Sawing
Planing / Routing
Others
Outdoor Power Equipment



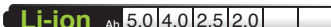

*Compatible batteries

HM001GM202 | HM001GZ
Price TBA | Price TBA

Cordless Demolition Hammer
Pemahat Tukul Tanpa Kord
充电式电动锤



*Recommended batteries 2.0Ah, 2.5Ah, 4.0Ah, 5.0Ah



- Anti-Vibration Technology (AVT) ensures extra-low vibration performance

Standard Equipment: Bit Grease, Side Grip, Cloth

- GM202: 1x Fast Charger, 2x 4.0Ah Battery
- GZ: Without Charger & Battery



Impact Energy Kekuatan Impak 单次最大锤击力	EPTA-Procedure 05/2009: 9.4J
Impacts Per Minute (IPM) Impak Per Minit 冲击数	0 - 2,650
Shank Diameter Diameter Shank 柄直径	18mm (11/16")
Dimensions (L x W x H) Dimensi 体积	481x113x258mm (19x4-7/16x10-1/8")
Net Weight Berat Bersih 净重	6.3 - 7.1kg (13.9 - 15.7lbs.)

HR005GM201 | HR005GZ 40mm (1-9/16")
RM 8,258 | RM 5,085

Cordless Rotary Hammer
Tukul Putar Tanpa Kord
充电式电钻



*Recommended batteries 2.0Ah, 2.5Ah, 4.0Ah, 5.0Ah



- Auto-start Wireless System (AWS) connects to compatible vacuum cleaners with Bluetooth

Standard Equipment: Side Handle, Side Grip, Depth Gauge, Bit Grease, Cloth

- GM201: 1x Fast Charger, 2x 4.0Ah Battery
- GZ: Without Charger & Battery



Impact Energy Kekuatan Impak 单次最大锤击力	EPTA-Procedure 05/2009: 8J
Capacity Kapasiti 能力	Concrete (w/ TCT Bit): 40mm (1-9/16")
Impacts Per Minute (IPM) Impak Per Minit 冲击数	1,450 - 2,900
No Load Speed (RPM) Kelajuan Tanpa Beban 回转数	250 - 500
Dimensions (L x W x H) Dimensi 体积	484x117x285mm (19x4-5/8x11-1/4")
Net Weight Berat Bersih 净重	7.5 - 8.0kg (16.5 - 17.6lbs.)

HR001GM201 28mm (1-1/8")
RM 6,373

Cordless Combination Hammer
Tukul Kombinasi Tanpa Kord
充电式冲击钻锤



*Recommended batteries 2.5Ah, 4.0Ah



- Auto-start Wireless System (AWS) connects to vacuum cleaner with Bluetooth

Standard Equipment: Side Grip, Depth Gauge, Cloth, Grease Vessel (194683-7)

- GM201: 1x Fast Charger, 2x 4.0Ah Battery



Impact Energy Kekuatan Impak 单次最大锤击力	EPTA-Procedure 05/2009: 2.8J Our experimental conditions: 3.2J
Capacity Kapasiti 能力	Concrete: 28mm(1-1/8") Steel: 13mm(1/2") Wood: 32mm(1-1/4") Core Bit: 54mm(2-1/8") Diamond Core Bit (Dry Type): 65mm (2-9/16")
Impact Per Minute (IPM) Impak Per Minit 冲击数	0 - 5,000
No Load Speed (RPM) Kelajuan Tanpa Beban 回转数	0 - 980
Dimensions (L x W x H) Dimensi 体积	358x102x232mm (14-1/8"x4"x9-1/8")
Net Weight Berat Bersih 净重	3.9 - 4.6kg (8.6 - 10.1lbs.)

HR002GM201 28mm (1-1/8")
RM 6,770

Cordless Combination Hammer
Tukul Kombinasi Tanpa Kord
充电式冲击钻锤



*Recommended batteries 2.5Ah, 4.0Ah



- Auto-start Wireless System (AWS) connects to vacuum cleaner with Bluetooth

Standard Equipment: Side Grip, Depth Gauge, Cloth, Grease Vessel (194683-7), Drill Chuck (199139-5)

- GM201: 1x Fast Charger, 2x 4.0Ah Battery



Impact Energy Kekuatan Impak 单次最大锤击力	EPTA-Procedure 05/2009: 2.9J
Capacity Kapasiti 能力	Concrete: 28mm(1-1/8") Steel: 13mm(1/2") Wood: 32mm(1-1/4") Core Bit: 54mm(2-1/8") Diamond Core Bit (Dry Type): 65mm (2-9/16")
Impact Per Minute (IPM) Impak Per Minit 冲击数	0 - 5,000
No Load Speed (RPM) Kelajuan Tanpa Beban 回转数	0 - 980
Dimensions (L x W x H) Dimensi 体积	389x102x232mm (15-1/4"x4"x9-1/8")
Net Weight Berat Bersih 净重	4.1 - 4.6kg (9.0 - 10.1lbs.)

HR003GM201 | HR003GZ 28mm (1-1/8")
RM 5,898 | RM 2,725

Cordless Combination Hammer
Tukul Kombinasi Tanpa Kord
充电式冲击钻锤

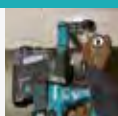

*Recommended batteries 2.5Ah, 4.0Ah



- 3-mode operation for "Rotation Only", "Hammering with Rotation" or "Hammering Only"

Standard Equipment: Side Grip, Depth Gauge

- GM201: 1x Fast Charger, 2x 4.0Ah Battery
- GZ: Without Charger, Battery & Carrying Case

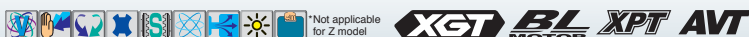

Impact Energy Kekuatan Impak 单次最大锤击力	EPTA-Procedure 05/2009: 2.8J Our experimental conditions: 3.2J
Capacity Kapasiti 能力	Concrete: 28mm(1-1/8") Steel: 13mm(1/2") Wood: 32mm(1-1/4") Core Bit: 54mm(2-1/8") Diamond Core Bit (Dry Type): 65mm (2-9/16")
Impact Per Minute (IPM) Impak Per Minit 冲击数	0 - 5,000
No Load Speed (RPM) Kelajuan Tanpa Beban 回转数	0 - 980
Dimensions (L x W x H) Dimensi 体积	358x121x232mm (14-1/8"x4-3/4"x9-1/8")
Net Weight Berat Bersih 净重	3.9 - 4.6kg (8.6 - 10.1lbs.)

* All list price shown are for reference only (exclude SST).

* Semua harga yang ditunjukkan adalah untuk rujukan sahaja (tidak termasuk SST). 所有显示的建议零售价仅供参考 (不包括SST)。





*Compatible batteries

DF002GD201 RM 3,892	DF002GA201 RM 3,035	DF002GZ 13mm (1/2") RM 1,085
-------------------------------	-------------------------------	--

Cordless Driver Drill
Gerudi Pemutar Skru Tanpa Kord
充电式螺丝起子电钻



*Recommended batteries 2.0Ah, 2.5Ah, 4.0Ah, 5.0Ah



• BL motor is electronically controlled to optimize battery energy use for longer run time per charge

Standard Equipment: (+/-) Bit, Belt Clip

- GD201: 1x Fast Charger, 2x 2.5Ah Battery
- GA201: 1x Standard Charger, 1x 2.0Ah Battery
- GZ: Without Charger, Battery & Carrying Case



*Not applicable for Z model



Capacity Kapasiti 能力	Steel: 13mm (1/2") Wood (Auger Bit): 38mm (1-1/2") Wood (Hole Saw): 51mm (2")
--------------------------------	---

Chuck Capacity Kapasiti Chuck 夹头能力	1.5 - 13mm (1/16" - 1/2")
--	---------------------------

No Load Speed (RPM) Kelajuan Tanpa Beban 回转数	High: 0 - 2,200 Low: 0 - 600
--	--------------------------------

Max Fastening Torque Tenaga Pemutaran Pengancing Maksimum 最大紧固扭力	Hard: 64N-m (570in.lbs.) Soft: 30N-m (270in.lbs.)
--	---

Max Lock Torque Pemutaran Tenaga Maksimum 最大扭力	65N-m (580in.lbs.)
--	--------------------

Clutch Torque Setting Tetapan Pemutaran 扭转设置	1.0 - 5.0N-m (9 - 44in.lbs.)
--	------------------------------

Dimensions (L x W x H) Dimensi 体积	164x86x272mm (6-1/2"x3-3/8"x10-3/4")
---	---

Net Weight Berat Bersih 净重	1.9 - 2.5kg (4.2 - 5.5lbs.)
--------------------------------------	-----------------------------

DF001GD201 RM 5,047	DF001GZ 13mm (1/2") RM 2,238
-------------------------------	--

Cordless Driver Drill
Gerudi Pemutar Skru Tanpa Kord
充电式螺丝起子电钻



*Recommended batteries 2.5Ah, 4.0Ah



• Excellent performance in continuous heavy duty applications

Standard Equipment: Side Grip, Belt Clip, (+/-) Bit, Bit Holder

- GD201: 1x Fast Charger, 2x 2.5Ah Battery
- GZ: Without Charger, Battery & Carrying Case



*Not applicable for Z model



Capacity Kapasiti 能力	Steel: 20mm (13/16") Wood (Auger-Bit): 50mm (2") Wood (Self-Feed Bit): 76mm (3") Wood (Hole Saw): 152mm (6") Siding Board: 220mm (8-5/8")
--------------------------------	---

Chuck Capacity Kapasiti Chuck 夹头能力	1.5 - 13mm (1/16" - 1/2")
--	---------------------------

No Load Speed (RPM) Kelajuan Tanpa Beban 回转数	High: 0 - 2,600 Low: 0 - 650
--	--------------------------------

Max Fastening Torque Tenaga Pemutaran Pengancing Maksimum 最大紧固扭力	Hard: 140N-m (1,240in.lbs.) Soft: 68N-m (600 in.lbs.)
--	---

Max Lock Torque Pemutaran Tenaga Maksimum 最大扭力	125N-m (1,100in.lbs.)
--	-----------------------

Dimensions (L x W x H) Dimensi 体积	181x86x275mm (7-1/8"x3-3/8"x10-7/8")
---	---

Net Weight Berat Bersih 净重	2.7 - 3.0kg (5.9 - 6.6lbs.)
--------------------------------------	-----------------------------

HP002GD201 RM 3,947	HP002GA201 RM 3,090	HP002GZ 13mm (1/2") RM 1,140
-------------------------------	-------------------------------	--

Cordless Hammer Driver Drill
Tukul Pemutar Skru Bergerudi Tanpa Kord
充电式冲击螺丝起子电钻

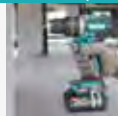

*Recommended batteries 2.0Ah, 2.5Ah, 4.0Ah, 5.0Ah



• Variable 2-speed (0-600 & 0-2,200 RPM) for a wide range of drilling, fastening and hammer drilling applications

Standard Equipment: (+/-) Bit, Belt Clip

- GD201: 1x Fast Charger, 2x 2.5Ah Battery
- GA201: 1x Standard Charger, 1x 2.0Ah Battery
- GZ: Without Charger, Battery & Carrying Case



*Not applicable for Z model



Capacity Kapasiti 能力	Steel: 13mm (1/2") Wood (Auger Bit): 38mm (1-1/2") Wood (Hole Saw): 51mm (2") Masonry: 13mm (1/2")
--------------------------------	---

Chuck Capacity Kapasiti Chuck 夹头能力	1.5 - 13mm (1/16" - 1/2")
--	---------------------------

Impacts Per Minute (IPM) Impak Per Minit 冲击数	High: 0 - 33,000 Low: 0 - 9,000
--	-----------------------------------

No Load Speed (RPM) Kelajuan Tanpa Beban 回转数	High: 0 - 2,200 Low: 0 - 600
--	--------------------------------

Max Fastening Torque Tenaga Pemutaran Pengancing Maksimum 最大紧固扭力	Hard: 64N-m (570in.lbs.) Soft: 30N-m (270in.lbs.)
--	---

Max Lock Torque Pemutaran Tenaga Maksimum 最大扭力	65N-m (580in.lbs.)
--	--------------------

Clutch Torque Setting Tetapan Pemutaran 扭转设置	1.0 - 5.0N-m (9 - 44in.lbs.)
--	------------------------------

Dimensions (L x W x H) Dimensi 体积	174x86x272mm (6-7/8"x3-3/8"x10-3/4")
---	---

Net Weight Berat Bersih 净重	2.0 - 2.6kg (4.4 - 5.7lbs.)
--------------------------------------	-----------------------------

HP001GD201 RM 5,100	HP001GZ 13mm (1/2") RM 2,293
-------------------------------	--

Cordless Hammer Driver Drill
Tukul Pemutar Skru Bergerudi Tanpa Kord
充电式冲击螺丝起子电钻

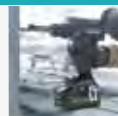

*Recommended batteries 2.5Ah, 4.0Ah



• Excellent performance in continuous heavy duty applications

Standard Equipment: Depth Gauge, Side Grip, Belt Clip, (+/-) Bit, Bit Holder

- GD201: 1x Fast Charger, 2x 2.5Ah Battery
- GZ: Without Charger, Battery & Carrying Case

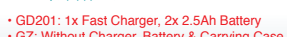

*Not applicable for Z model



Capacity Kapasiti 能力	Steel: 20mm (13/16") Wood (Auger-Bit): 50mm (2") Wood (Self-Feed Bit): 76mm (3") Wood (Hole Saw): 152mm (6") Siding Board: 220mm (8-5/8") Masonry: 20mm (13/16")
--------------------------------	--

Chuck Capacity Kapasiti Chuck 夹头能力	1.5 - 13mm (1/16" - 1/2")
--	---------------------------

Impacts Per Minute (IPM) Impak Per Minit 冲击数	High: 0 - 39,000 Low: 0 - 9,750
--	-----------------------------------

No Load Speed (RPM) Kelajuan Tanpa Beban 回转数	High: 0 - 2,600 Low: 0 - 650
--	--------------------------------

Max Fastening Torque Tenaga Pemutaran Pengancing Maksimum 最大紧固扭力	Hard: 140N-m (1,240in.lbs.) Soft: 68N-m (600 in.lbs.)
--	---

Max Lock Torque Pemutaran Tenaga Maksimum 最大扭力	125N-m (1,100in.lbs.)
--	-----------------------

Dimensions (L x W x H) Dimensi 体积	182x86x275mm (7-1/8"x3-3/8"x10-7/8")
---	---

Net Weight Berat Bersih 净重	2.7 - 3.0kg (6.0 - 6.6lbs.)
--------------------------------------	-----------------------------

TD001GD201 RM 4,525	TD001GZ RM 1,717
-------------------------------	----------------------------

Cordless Impact Driver
Pemutar Skru Impak Tanpa Kord
充电式冲击螺丝起子机



*Recommended batteries 2.5Ah, 4.0Ah



• 4-speed power selection plus 6 Assist modes (2 T-modes, 1 Wood mode, 3 Bolt modes)

Standard Equipment: Belt Clip

- GD201: 1x Fast Charger, 2x 2.5Ah Battery
- GZ: Without Charger, Battery & Carrying Case

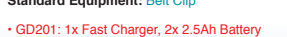

*Not applicable for Z model



Capacity Kapasiti 能力	Machine Screw: M4 - M8 (5/32" - 5/16") Standard Bolt: M5 - M16 (3/16" - 5/8")
--------------------------------	--

Hex Shank Batang Heksagon 六角柄	High Strength Bolt: M5 - M14 (3/16" - 9/16") Coarse thread (in length): 22 - 125 mm (7/8" - 4-7/8") 6.35 mm (1/4")
---	--

No Load Speed (RPM) Kelajuan Tanpa Beban 回转数	Max / Hard / Med / Soft / Wood / Bolt (1) / Bolt (2) / Bolt (3) / T (1) / T (2) mode: 0 - 3,700 / 3,200 / 2,100 / 1,100 / 1,800 / 2,500 / 3,700 / 3,700 / 2,400 / 3,700
--	---

Impacts Per Minute (IPM) Impak Per Minit 冲击数	Max / Hard / Med / Soft / Wood / Bolt (1) / Bolt (2) / Bolt (3) / T (1) / T (2) mode: 0 - 4,400 / 3,600 / 2,600 / 1,100 / 4,400 / N/A / 4,400 / 4,400 / N/A / 2,600
--	---

Max Fastening Torque Tenaga Pemutaran Pengancing Maksimum 最大紧固扭力	220N-m (1,950in.lbs.)
--	-----------------------

Fastening Torque Tenaga Pemutaran Pengancing 扭力	Hard: 170N-m(1,510in.lbs.) Med: 50N-m(440in.lbs.) Soft: 20N-m (180in.lbs.)
---	--

Dimensions (L x W x H) Dimensi 体积	120x86x245mm (4-3/4"x3-3/8"x9-5/8")
---	--

Net Weight Berat Bersih 净重	1.7 - 2.0kg (3.7 - 4.4lbs.)
--------------------------------------	-----------------------------

* All list price shown are for reference only (exclude SST).

* Semua harga yang ditunjukkan adalah untuk rujukan sahaja (tidak termasuk SST). 所有显示的建议零售价仅供参考 (不包括SST)。

Cordless Lampu Kordless
LED Flashlight Lampu Cahaya LED
Vacuum Cleaner Pembersih Vakuum
Drilling / Fastening
Impact Drilling / Demolition
Cutting / Trimming
Grinding / Sanding
Sawing / Chaining
Planing / Routing
Others
Outdoor Power Equipment





*Compatible batteries

Cordless Impact Wrench

Perengkuh Impak Tanpa Kord 充电式冲击套筒扳手



Pin detent TW005G

*Jumlah Kerja 工作量
Work Amount
 with BL4025 x2
 continuous tightening of M16 bolts
 in an environment with a
 temperature at 40 °C

560 bolts
 (approx.)

Number of bolts consecutively
 tightened under heavy load

Nut-busting Torque
 Tork Pengetatan Bolt
 螺栓拧紧扭力

630 N·m

Max Fastening Torque
 Tenaga Pemutaran Pengancing
 Maksimum 最大紧固扭力

350 N·m

TW005GD201 RM 4,463 | **TW005GZ** 12.7mm (1/2") RM 1,655

Cordless Impact Wrench
 Perengkuh Impak Tanpa Kord
 充电式冲击套筒扳手



*Recommended batteries 2.0Ah, 2.5Ah, 4.0Ah



• 3 modes of reaction time for automatic stop available both in forward and reverse rotation modes

Standard Equipment: Belt Clip, Tool Hanger Set (191K57-9)

- GD201: 1x Fast Charger, 2x 2.5Ah Battery
- GZ: Without Charger, Battery & Carrying Case

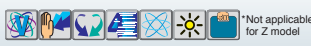

*Not applicable for Z model



Fastening Capacities Keupayaan Pengancing 紧固能力	Standard Bolt: M10 - M20 (3/8" - 3/4") High Strength Bolt: M10 - M16 (3/8" - 5/8")
Square Drive Skrus Persegi 方形螺栓	12.7mm (1/2"), Pin detent
No Load Speed (RPM) Kelajuan Tanpa Beban 回转数	Max: 0 - 3,200 Hard: 2,600 Medium: 1,800 Soft: 1,000
Impacts Per Minute (IPM) Impak Per Minit 冲击数	Max: 0 - 4,000 Hard: 3,400 Medium: 2,600 Soft: 1,800
Max Fastening Torque Pemutaran Tenaga Maksimum 最大扭矩	350N·m (260ft.lbs.)
Nut-Busting Torque Tork Pengetatan Bolt 螺栓拧紧扭力	630N·m (465ft.lbs.)
Dimensions (L x W x H) Dimensi 体积	144x86x248mm (5-5/8x3-3/8x9-3/4")
Net Weight Berat Bersih 净重	1.9 - 2.2kg (4.2 - 4.9lbs.)

TW001GM201 RM 6,568 | **TW001GZ** 19mm (3/4") RM 3,397

Cordless Impact Wrench
 Perengkuh Impak Tanpa Kord
 充电式冲击套筒扳手



*Recommended batteries 2.5Ah, 4.0Ah

• Higher torque and more compact than DTW1001

Standard Equipment: Belt Clip

- GM201: 1x Fast Charger, 2x 4.0Ah Battery
- GZ: Without Charger, Battery & Carrying Case



*Not applicable for Z model



QR Code: TW001G
 VIDEO CLIP
 Models and specs may vary by country



Fastening Capacities Kapasiti 能力	Standard Bolt: M12 - M36 (1/2" - 1-7/16") High Strength Bolt: M10 - M27 (3/8" - 1-1/16")
Square Drive Batang Segi Empat 四方头	19mm (3/4"), C-ring
No Load Speed (RPM) Kelajuan Tanpa Beban 回转数	Max: 0 - 1,800 Hard: 1,400 Mid: 1,150 Soft: 950
Impacts Per Minute (IPM) Impak Per Minit 冲击数	Max: 0 - 2,500 Hard: 2,400 Mid: 2,200 Soft: 1,900
Max Fastening Torque Tenaga Pemutaran Pengancing Maksimum 最大紧固扭力	1,800N·m (1,330ft.lbs.)
Nut-Busting Torque Tork Pengetatan Bolt 螺栓拧紧扭力	2,050N·m (1,510ft.lbs.)
Dimensions (L x W x H) Dimensi 体积	217x94x297mm (8-1/2"x3-11/16"x11-3/4")
Net Weight Berat Bersih 净重	3.9 - 4.2kg (8.6 - 9.3lbs.)
Work Amount (approx.) Jumlah Kerja 工作量	870pcs with BL4040 x2 Tightening of M24 bolts

* All list price shown are for reference only (exclude SST).

* Semua harga yang ditunjukkan adalah untuk rujukan sahaja (tidak termasuk SST). 所有显示的建议零售价仅供参考 (不包括SST)。

Cordless
Tempat Kerja 100%

LED Flashlight
Lampu Sinar LED
- LED LIGHT

Vacuum Cleaner
Penyedut Debu
- BLU

Drilling / Fastening
Galian / Pengancing
M10 / M12

Impact Drilling / Demolition
Galian / Pecah
M10 / M12

Cutting
Pemotongan
- 1/2"

Grinding / Smoothing
Pengiraan / Mulus
- 1/2"

Others
Lain-lain
- 1/2"

Outdoor Power Equipment
Alatan Kuat Daya
- 1/2"



*Compatible batteries

Cordless Angle Grinder

Pengisar Sudut Tanpa Kord 充电式角向磨光机

Delivers same power as 1,000W corded grinders

Memberi kuasa yang sama dengan Pengisar Sudut 1,000W
提供与1,000W有线打磨机相同的功率

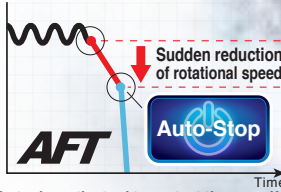

Shuts down the tool to protect the user, if the rotation speed suddenly slows down
Alat kuasa akan berhenti secara automatic untuk melindungi pengguna jika kelajuan putaran tiba-tiba melambat
若旋转速度突然降低，工具将自动关闭以保护使用者



Active Feedback Sensing Technology
Teknologi Sensor Maklum Balas Automatik
自动回馈感应科技

Model No. 型号					No Load Speed (rpm) Kelajuan Tanpa Beban 回转数	Switch Suis 开关	BL MOTOR	XPT	AFT	BRAKE	AWS	Anti-restart function Fungsi restart semula 防重启功能
100mm	125mm	150mm	180mm	230mm								
GA003G	GA005G	GA035G	-	-	8,500	Slide	•	•	•	•	•	•
GA011G	GA013G	GA036G	-	-	8,500	Paddle	•	•	•	•	•	•
GA021G	GA023G	-	-	-	3,000 - 8,500	Slide	•	•	•	•	•	•
GA027G	GA029G	-	GA037G	GA038G	3,000 - 8,500	Paddle	•	•	•	•	•	•

GA003GM201 RM 4,867 | **GA003GD201** RM 4,502 | **GA003GZ** 100mm (4") RM 1,695

Cordless Angle Grinder
Pengisar Sudut Tanpa Kord
充电式角向磨光机



Top Slide Switch
Suis Gelangsar Atas 顶部滑动开关
Convenient for left & right handed
Mudah diguna dengan tangan kiri atau kanan 方便左右手操作

*Recommended batteries 2.5Ah, 4.0Ah, 5.0Ah

• Excellent in continuous heavy-duty work

Standard Equipment: Grinding Wheel (A-80852), Wheel Cover, Side Grip, Lock Nut Wrench

- GM201: 1x Fast Charger, 2x 4.0Ah Battery
- GD201: 1x Fast Charger, 2x 2.5Ah Battery
- GZ: Without Charger, Battery & Carrying Case



Wheel Diameter 100mm (4")
Diameter Roda 轮片直径

Hole Diameter 16mm (5/8")
Diameter Lubang 孔直径

Max Wheel Thickness 6.4mm (1/4")
Ketebalan Roda Maksimum 最大轮片厚度

No Load Speed (RPM) 8,500
Kelajuan Tanpa Beban 回转数

Dimensions (L x W x H) 398x117x150mm
Dimensi 体积

Net Weight 2.8 - 3.3kg (6.2 - 7.3lbs.)
Berat Bersih 净重

GA011GM201 RM 4,960 | **GA011GD201** RM 4,595 | **GA011GZ** 100mm (4") RM 1,788

Cordless Angle Grinder
Pengisar Sudut Tanpa Kord
充电式角向磨光机

Paddle Switch
Suis Pemicu 扳机开关

*Recommended batteries 2.5Ah, 4.0Ah, 5.0Ah

• Genuine solution for high demand industrial applications

Standard Equipment: Grinding Wheel (A-80852), Wheel Cover, Side Grip, Lock Nut Wrench

- GM201: 1x Fast Charger, 2x 4.0Ah Battery
- GD201: 1x Fast Charger, 2x 2.5Ah Battery
- GZ: Without Charger, Battery & Carrying Case



Wheel Diameter 100mm (4")
Diameter Roda 轮片直径

Hole Diameter 16mm (5/8")
Diameter Lubang 孔直径

Max Wheel Thickness 6.4mm (1/4")
Ketebalan Roda Maksimum 最大轮片厚度

No Load Speed (RPM) 8,500
Kelajuan Tanpa Beban 回转数

Dimensions (L x W x H) 398x117x150mm
Dimensi 体积

Net Weight 2.8 - 3.4kg (6.2 - 7.5lbs.)
Berat Bersih 净重

GA021GM201 RM 5,055 | **GA021GD201** RM 4,690 | **GA021GZ** 100mm (4") RM 1,883

Cordless Angle Grinder
Pengisar Sudut Tanpa Kord
充电式角向磨光机

Top Slide Switch
Suis Gelangsar Atas 顶部滑动开关
Convenient for left & right handed
Mudah diguna dengan tangan kiri atau kanan 方便左右手操作

*Recommended batteries 2.5Ah, 4.0Ah, 5.0Ah

• Auto-start Wireless System (AWS) connects to compatible vacuum cleaners with Bluetooth

Standard Equipment: Grinding Wheel (A-80852), Wheel Cover, Side Grip, Lock Nut Wrench

- GM201: 1x Fast Charger, 2x 4.0Ah Battery
- GD201: 1x Fast Charger, 2x 2.5Ah Battery
- GZ: Without Charger, Battery & Carrying Case



Wheel Diameter 100mm (4")
Diameter Roda 轮片直径

Hole Diameter 16mm (5/8")
Diameter Lubang 孔直径

Max Wheel Thickness 6.4mm (1/4")
Ketebalan Roda Maksimum 最大轮片厚度

No Load Speed (RPM) 3,000 - 8,500
Kelajuan Tanpa Beban 回转数

Dimensions (L x W x H) 413x117x150mm
Dimensi 体积

Net Weight 2.8 - 3.4kg (6.2 - 7.5lbs.)
Berat Bersih 净重

* All list price shown are for reference only (exclude SST).

* Semua harga yang ditunjukkan adalah untuk rujukan sahaja (tidak termasuk SST). 所有显示的建议零售价仅供参考 (不包括SST)。

Cordless
Terdapat Kordless

LED Flashlight
Lampu Cahaya LED
LED BRIGHT

Vacuum Cleaner
Penyedut Vakum
MILK

Drilling / Fastening
Drool / Pengikat
MILK

Impact Drilling / Demolition
Drool / Demolish
MILK

Cutting / Finishing
Potong / Finishing
MILK

Grinding / Sanding
Grinding / Sanding
MILK

Sawing / Chaining
Gigit / Chaining
MILK

Planing / Routing
Planing / Routing
MILK

Others / Lain-lain
MILK

Outdoor Power Equipment
Alat Kuasa Luar
MILK

Makita
MILK

40V^{Li-ion} max

XGT

Li-ion Ah 5.0 4.0 2.5 2.0

*Compatible batteries

GA027GM201 RM 5,152 | **GA027GD201** RM 4,787 | **GA027GZ** 100mm (4") RM 1,980

Cordless Angle Grinder
Pengisar Sudut Tanpa Kord
充电式角向磨光机

Paddle Switch
Suis Pemicu 拨机开关

*Recommended batteries
2.5Ah, 4.0Ah, 5.0Ah

- Auto-start Wireless System (AWS) connects to compatible vacuum cleaners with Bluetooth

Standard Equipment: Grinding Wheel (A-80852), Wheel Cover, Side Grip, Lock Nut Wrench

- GM201: 1x Fast Charger, 2x 4.0Ah Battery
- GD201: 1x Fast Charger, 2x 2.5Ah Battery
- GZ: Without Charger, Battery & Carrying Case



*Not applicable for Z model



Wheel Diameter Diameter Roda 轮片直径	100mm (4")
Hole Diameter Diameter Lubang 孔直径	16mm (5/8")
Max Wheel Thickness Ketebalan Roda Maksimum 最大轮片厚度	6.4mm (1/4")
No Load Speed (RPM) Kelajuan Tanpa Beban 回转数	3,000 - 8,500
Dimensions (L x W x H) Dimensi 体积	413x117x150mm (16-1/4"x4-5/8"x5-7/8")
Net Weight Berat Bersih 净重	2.9 - 3.4kg (6.4 - 7.5lbs.)

GA005GM201 RM 4,865 | **GA005GD201** RM 4,502 | **GA005GZ** 125mm (5") RM 1,693

Cordless Angle Grinder
Pengisar Sudut Tanpa Kord
充电式角向磨光机

Top Slide Switch
Suis Gelang Atas 顶部滑动开关

*Recommended batteries
2.5Ah, 4.0Ah, 5.0Ah

Convenient for left & right handed
Mudah diguna dengan tangan kiri atau kanan 方便左右操作

- Genuine solution for high demand industrial applications

Standard Equipment: Grinding Wheel (A-80656), Wheel Cover, Side Grip, Lock Nut Wrench

- GM201: 1x Fast Charger, 2x 4.0Ah Battery
- GD201: 1x Fast Charger, 2x 2.5Ah Battery
- GZ: Without Charger, Battery & Carrying Case



*Not applicable for Z model

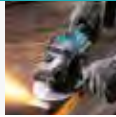

Wheel Diameter Diameter Roda 轮片直径	125mm (5")
Hole Diameter Diameter Lubang 孔直径	22.23mm (7/8")
Max Wheel Thickness Ketebalan Roda Maksimum 最大轮片厚度	7.2mm (9/32")
No Load Speed (RPM) Kelajuan Tanpa Beban 回转数	8,500
Dimensions (L x W x H) Dimensi 体积	398x140x156mm (15-5/8"x5-1/2"x6-1/8")
Net Weight Berat Bersih 净重	2.9 - 3.6kg (6.4 - 7.9lbs.)

GA013GM201 RM 4,960 | **GA013GD201** RM 4,595 | **GA013GZ** 125mm (5") RM 1,788

Cordless Angle Grinder
Pengisar Sudut Tanpa Kord
充电式角向磨光机

Paddle Switch
Suis Pemicu 拨机开关

*Recommended batteries
2.5Ah, 4.0Ah, 5.0Ah

- BL motor to run cooler and more efficiently for longer life

Standard Equipment: Grinding Wheel (A-80656), Wheel Cover, Side Grip, Lock Nut Wrench

- GM201: 1x Fast Charger, 2x 4.0Ah Battery
- GD201: 1x Fast Charger, 2x 2.5Ah Battery
- GZ: Without Charger, Battery & Carrying Case



*Not applicable for Z model

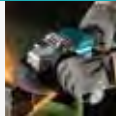

Wheel Diameter Diameter Roda 轮片直径	125mm (5")
Hole Diameter Diameter Lubang 孔直径	22.23mm (7/8")
Max Wheel Thickness Ketebalan Roda Maksimum 最大轮片厚度	7.2mm (9/32")
No Load Speed (RPM) Kelajuan Tanpa Beban 回转数	8,500
Dimensions (L x W x H) Dimensi 体积	398x140x156mm (15-5/8"x5-1/2"x6-1/8")
Net Weight Berat Bersih 净重	3.0 - 3.6kg (6.6 - 7.9lbs.)



VIDEO CLIP
Models and specs may vary by country

GA023GM201 RM 5,057 | **GA023GD201** RM 4,692 | **GA023GZ** 125mm (5") RM 1,885

Cordless Angle Grinder
Pengisar Sudut Tanpa Kord
充电式角向磨光机

Top Slide Switch
Suis Gelang Atas 顶部滑动开关

*Recommended batteries
2.5Ah, 4.0Ah, 5.0Ah

Convenient for left & right handed
Mudah diguna dengan tangan kiri atau kanan 方便左右操作

- Auto-start Wireless System (AWS) connects to compatible vacuum cleaners with Bluetooth

Standard Equipment: Grinding Wheel (A-80656), Wheel Cover, Side Grip, Lock Nut Wrench

- GM201: 1x Fast Charger, 2x 4.0Ah Battery
- GD201: 1x Fast Charger, 2x 2.5Ah Battery
- GZ: Without Charger, Battery & Carrying Case



*Not applicable for Z model

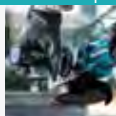

Wheel Diameter Diameter Roda 轮片直径	125mm (5")
Hole Diameter Diameter Lubang 孔直径	22.23mm (7/8")
Max Wheel Thickness Ketebalan Roda Maksimum 最大轮片厚度	7.2mm (9/32")
No Load Speed (RPM) Kelajuan Tanpa Beban 回转数	3,000 - 8,500
Dimensions (L x W x H) Dimensi 体积	413x140x156mm (16-1/4"x5-1/2"x6-1/8")
Net Weight Berat Bersih 净重	3.0 - 4.4kg (6.6 - 9.7lbs.)

GA029GM201 RM 5,152 | **GA029GD201** RM 4,787 | **GA029GZ** 125mm (5") RM 1,980

Cordless Angle Grinder
Pengisar Sudut Tanpa Kord
充电式角向磨光机

Paddle Switch
Suis Pemicu 拨机开关

*Recommended batteries
2.5Ah, 4.0Ah, 5.0Ah

- Auto-start Wireless System (AWS) connects to compatible vacuum cleaners with Bluetooth

Standard Equipment: Grinding Wheel (A-80656), Wheel Cover, Side Grip, Lock Nut Wrench

- GM201: 1x Fast Charger, 2x 4.0Ah Battery
- GD201: 1x Fast Charger, 2x 2.5Ah Battery
- GZ: Without Charger, Battery & Carrying Case



*Not applicable for Z model



Wheel Diameter Diameter Roda 轮片直径	125mm (5")
Hole Diameter Diameter Lubang 孔直径	22.23mm (7/8")
Max Wheel Thickness Ketebalan Roda Maksimum 最大轮片厚度	7.2mm (9/32")
No Load Speed (RPM) Kelajuan Tanpa Beban 回转数	3,000 - 8,500
Dimensions (L x W x H) Dimensi 体积	413x140x156mm (16-1/4"x5-1/2"x6-1/8")
Net Weight Berat Bersih 净重	3.0 - 4.5kg (6.6 - 9.9lbs.)

* All list price shown are for reference only (exclude SST).

* Semua harga yang ditunjukkan adalah untuk rujukan sahaja (tidak termasuk SST). 所有显示的建议零售价仅供参考 (不包括SST)。

Cordless
Tools & Accessories

LED Flashlight
Lampu Senter LED
- LED LIGHT

Vacuum Cleaner
Penyedut Hava
- BLUET

Drilling / Fastening
Gergaji / Pengikat
- BLUET

Impact Drilling / Demolition
Gergaji / Pecah
- BLUET

Cutting / Finishing
Gergaji / Finishing
- BLUET

Grinding / Sanding
Pengisar / Hiruskan
- BLUET

Sawing
Gergaji
- BLUET

Planing / Routing
Pajangan / Tugasan
- BLUET

Others
Lain-lain
- BLUET

Outdoor Power Equipment
Alatan Kuasa Luar
- BLUET

Thakita
- BLUET



*Compatible batteries

GA035GZ 150mm (6")
RM 1,705

Cordless Angle Grinder
Pengisar Sudut Tanpa Kord
充电式角向磨光机



Top Slide Switch

Suis Gelangsar Atas 顶部滑动开关
Convenient for left & right handed
Mudah diguna dengan tangan kiri atau kanan 方便左右手

*Recommended batteries
2.5Ah, 4.0Ah, 5.0Ah

Improved heat dissipation capacity of the controller allows for continuous heavy-duty applications

Standard Equipment: Grinding Wheel (A-80846), Toolless Wheel Cover, Side Grip, Lock Nut Wrench

*GZ: Without Charger & Battery



Wheel Diameter Diameter Roda Pengisar 砂轮片直径	150mm (6")
Hole Diameter Diameter Lubang 孔直径	22.23mm (7/8")
Max Wheel Thickness Ketebalan Roda Maksimum 最大砂轮片厚度	6.4mm (1/4")
No Load Speed (RPM) Kelajuan Tanpa Beban 回转数	8,500
Dimensions (L x W x H) Dimensi 体积	398x171x156mm (15-5/8x6-3/4x6-1/8")
Net Weight Berat Bersih 淨重	3.0-4.0kg (6.6-8.8lbs.)



GA035G/ZA036G
Models and specs may vary by country

GA036GZ 150mm (6")
RM 1,795

Cordless Angle Grinder
Pengisar Sudut Tanpa Kord
充电式角向磨光机



Paddle Switch

Suis Pemacu 扳机开关

*Recommended batteries
2.5Ah, 4.0Ah, 5.0Ah

Improved heat dissipation capacity of the controller allows for continuous heavy-duty applications

Standard Equipment: Grinding Wheel (A-80846), Toolless Wheel Cover, Side Grip, Lock Nut Wrench

*GZ: Without Charger & Battery



Wheel Diameter Diameter Roda Pengisar 砂轮片直径	150mm (6")
Hole Diameter Diameter Lubang 孔直径	22.23mm (7/8")
Max Wheel Thickness Ketebalan Roda Maksimum 最大砂轮片厚度	6.4mm (1/4")
No Load Speed (RPM) Kelajuan Tanpa Beban 回转数	8,500
Dimensions (L x W x H) Dimensi 体积	398x171x156mm (15-5/8x6-3/4x6-1/8")
Net Weight Berat Bersih 淨重	3.0-4.0kg (6.6-8.8lbs.)



GA035G/ZA036G
Models and specs may vary by country

GA037GT201 | **GA037GM201** | **GA037GZ** 180mm (7")
RM 5,587 | RM 4,968 | RM 1,795

Cordless Angle Grinder
Pengisar Sudut Tanpa Kord
充电式角向磨光机



Paddle Switch

Suis Pemacu 扳机开关

*Recommended batteries
2.5Ah, 4.0Ah, 5.0Ah

Auto-start Wireless System (AWS) Connects to Compatible Vacuum Cleaners with Bluetooth

Standard Equipment: Toolless Wheel Cover, Side Grip, Lock Nut Wrench

*GT201: 1x Fast Charger, 2x 5.0Ah Battery
*GM201: 1x Fast Charger, 2x 4.0Ah Battery
*GZ: Without Charger & Battery



Wheel Diameter Diameter Roda Pengisar 砂轮片直径	180mm (7")
Hole Diameter Diameter Lubang 孔直径	22.23mm (7/8")
Max Wheel Thickness Ketebalan Roda Maksimum 最大砂轮片厚度	7.2mm (1/4")
No Load Speed (RPM) Kelajuan Tanpa Beban 回转数	7,800
Dimensions (L x W x H) Dimensi 体积	499x200x180mm (19-5/8x7-7/8x7-1/8")
Net Weight Berat Bersih 淨重	4.4 - 5.2kg (9.7 - 11.0lbs.)



GA035G/ZA036G
Models and specs may vary by country

GA038GT201 | **GA038GM201** | **GA038GZ** 230mm (9")
RM 5,602 | RM 4,982 | RM 1,810

Cordless Angle Grinder
Pengisar Sudut Tanpa Kord
充电式角向磨光机



Paddle Switch

Suis Pemacu 扳机开关

*Recommended batteries
2.5Ah, 4.0Ah, 5.0Ah

Auto-start Wireless System (AWS) Connects to Compatible Vacuum Cleaners with Bluetooth

Standard Equipment: Toolless Wheel Cover, Side Grip, Lock Nut Wrench

*GT201: 1x Fast Charger, 2x 5.0Ah Battery
*GM201: 1x Fast Charger, 2x 4.0Ah Battery
*GZ: Without Charger & Battery



Wheel Diameter Diameter Roda Pengisar 砂轮片直径	230mm (9")
Hole Diameter Diameter Lubang 孔直径	22.23mm (7/8")
Max Wheel Thickness Ketebalan Roda Maksimum 最大砂轮片厚度	6.5mm (1/4")
No Load Speed (RPM) Kelajuan Tanpa Beban 回转数	6,600
Dimensions (L x W x H) Dimensi 体积	509x250x164mm (20x9-7/8x6-1/2")
Net Weight Berat Bersih 淨重	4.6 - 7.4kg (10.1 - 16.3lbs.)

LS002GZ 216mm (8-1/2")
Price TBA

Cordless Slide Compound Miter Saw
Gergaji Kompaun Miter Tanpa Kord
充电式斜锯



*Recommended batteries 2.5Ah, 4.0Ah, 5.0Ah

Auto-start Wireless System (AWS) connects to compatible vacuum cleaners with Bluetooth

Standard Equipment: Efficut TCT Saw Blade (E-07010), Dust Bag, Triangular Rule, Vertical Vise, Hex Wrench

*GZ: Without Charger & Battery



Blade Diameter Diameter Bilah 锯片直径	216mm (8-1/2")
Hole Diameter Diameter Lubang 孔直径	25.4mm (1")
Angle Sudut 角度	Miter: 60°L / 60°R Bevel: 48°L / 48°R
Max Cutting Capacity Kapasiti Pemotongan Maksimum 最大切割能力	(Bevel 45°L / Miter 45°LR) 50x220mm (2x8-5/8") (Bevel 45°L / Miter 0°) 50x312mm (2x12-1/4") (Bevel 45°R / Miter 45°LR) 30x220mm (1-3/16x8-5/8") (Bevel 45°R / Miter 0°) 30x312mm (1-3/16x12-1/4") (Bevel 0° / Miter 45°LR) 70x220mm (2-3/4x8-5/8") (Bevel 0° / Miter 0°) 70x312mm (2-3/4x12-1/4") (Bevel 0° / Miter 60°R) 70x155mm (2-3/4x6-1/8")
No Load Speed (RPM) Kelajuan Tanpa Beban 回转数	4,800
Dimensions (L x W x H) Dimensi 体积	702x551x557mm (27-5/8x21-3/4x22")
Net Weight Berat Bersih 淨重	16.4 - 17.0kg (36.2 - 37.6lbs.)

* All list price shown are for reference only (exclude SST).

* Semua harga yang ditunjukkan adalah untuk rujukan sahaja (tidak termasuk SST). 所有显示的建议零售价仅供参考 (不包括SST)。

Cordless Impact Driver
LED Flashlight
Vacuum Cleaner
Drilling / Fastening
Impact Drilling / Demolition
Cutting / Penetrating
Grinding / Sanding
Sawing
Planing / Routing
Others
Outdoor Power Equipment





Cordless Circular Saw

Gergaji Piring Tanpa Kord 充电式圆锯



Lightweight
Ringan 轻量
4.7 kg
with BL4040
4.0Ah Battery



Compatible with guide rail without adapter

Boleh bersambung dengan rel panduan tanpa penyesuai 直接连接导轨使用

HS004G

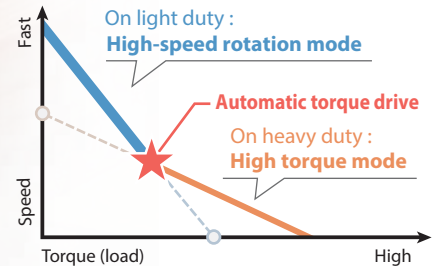

ADT
Automatic Torque Drive Technology
Teknologi Tork Automatik
自动扭力驱动科技

HS004GM201 | **HS004GZ** 190 / 185mm (7-1/2" / 7-1/4")
RM 6,220 | RM 3,048

Cordless Circular Saw
Gergaji Piring Tanpa Kord
充电式圆锯



*Recommended batteries 2.5Ah, 4.0Ah



• Lightweight & High Power

Standard Equipment: TCT Saw Blade (B-62022), Dust Nozzle, Hex Wrench, Guide Rule

• GM201: 1x Fast Charger, 2x 4.0Ah Battery
• GZ: Without Charger, Battery & Carrying Case



Blade Diameter Diameter Bilah 锯片直径	190mm (7-1/2") 185mm (7-1/4")
Max Cutting Capacity Kapasiti Pemotongan Maksimum 最大切割能力	90°: 62.5 / 60 mm (2-7/16" / 2-3/8") 45°: 44.5 / 43 mm (1-3/4" / 1-11/16") 48°: 42 / 41 mm (1-5/8" / 1-5/8")
No Load Speed (RPM) Kelajuan Tanpa Beban 回转数	6,000
Dimensions (L x W x H) Dimensi 体积	322x210x290mm (12-5/8"x8-1/4"x11-3/8")
Net Weight Berat Bersih 净重	4.4 - 4.7kg (9.7 - 10.4lbs.)
Work Amount (approx.) Jumlah Kerja 工作量	145pcs Melapi thickness: 60mm, width: 300mm 31pcs SPF 2 x 10 with BL4040

JR001GM201 | **JR001GZ**
RM 5,312 | RM 2,140

Cordless Recipro Saw
Gergaji Resipro Tanpa Kord
充电式往复锯

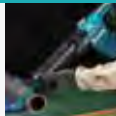

*Recommended batteries 2.5Ah, 4.0Ah



• Compact & High Power

Standard Equipment: Recipro Saw Blades 3pcs (B-05038, B-05044, B-05153)

• GM201: 1x Fast Charger, 2x 4.0Ah Battery
• GZ: Without Charger, Battery & Carrying Case



Length of Stroke Panjang Strok 冲程长度	32mm (1-1/4")
Strokes Per Minute (SPM) Kelajuan Strok 冲程速度	High: 0 - 3,000 Low: 0 - 2,300
Capacity Kapasiti 能力	Pipe: 130mm (5-1/8") Wood: 255mm (10")
Dimensions (L x W x H) Dimensi 体积	457x88x233mm (18"x3-1/2"x9-1/8")
Net Weight Berat Bersih 净重	4.2 - 4.5kg (9.3 - 9.9lbs.)



FN001GD101 | **FN001GZ**
Price TBA | Price TBA

Cordless Brad Nailer
Mesin Pemaku Tanpa Kord
充电式打钉机



*Recommended batteries 2.0Ah, 2.5Ah, 4.0Ah, 5.0Ah



• High power to drive brad nails up to 40mm; 35mm into hard materials such as red oak

Standard Equipment: Safety Goggles, Nose Adapter, Hex Wrench, Belt Clip

• GD101: 1x Fast Charger, 1x 2.5Ah Battery
• GZ: Without Charger, Battery & Carrying Case



Capacity Kapasiti 能力	Length: 15 - 40mm (5/8" - 1-5/8") Gauge: 18Ga
Magazine Capacity Bilangan Staples 装钉个数	100
Dimensions (L x W x H) Dimensi 体积	265x86x243mm (10-3/8x3-3/8x9-9/16")
Net Weight Berat Bersih 净重	2.6 - 3.2kg (5.7 - 7.1lbs.)
Work Amount (approx.) Jumlah Kerja 工作量	5000pcs with BL4025

Accessories (optional)			
Description	Size	Pcs/ Box	Part No.
Brad Nail 15mm (5/8")	F15	5,000	B-04307
Brad Nail 20mm (3/4")	F20	5,000	B-04313
Brad Nail 25mm (1")	F25	5,000	B-04329
Brad Nail 30mm (1-3/16")	F30	5,000	B-04335
Brad Nail 35mm (1-3/8")	F35	5,000	B-04357



* All list price shown are for reference only (exclude SST).

* Semua harga yang ditunjukkan adalah untuk rujukan sahaja (tidak termasuk SST). 所有显示的建议零售价仅供参考 (不包括SST)。

Cordless
Tempat
LED Flashlight
Vacuum Cleaner
Drilling / Fastening
Impact Drilling / Demolition
Cutting
Grinding / Sanding
Sawing
Planing / Routing
Others
Outdoor Power Equipment





*Compatible batteries

UR003GZ

RM 2,533

Cordless Grass Trimmer

Pemotong Rumput Tanpa Kord
充电式割草机

*Recommended batteries 2.0Ah, 2.5Ah, 4.0Ah, 5.0Ah

• WetGuard; Excellent water-resistant performance

Standard Equipment: Safety Goggle, Blade Cover, Nylon Cutting Head (198892-0), Accessory Bag, Hex Wrench, Shoulder Belt

• GZ: Without Charger & Battery



Cutting Width

Lebar Keratan 切割宽度

Metal Blade: 230mm (9")

TCT Saw Blade: 255mm (10")

Nylon Cutting Head: 350mm (13-3/4")

Plastic Blade: 255mm (10")

High: 0 - 6,500 | Mid: 5,300 |

Low: 3,500

M10 x 1.25LH

No Load Speed (RPM)

Kelajuan Tanpa Beban 回转数

Spindle Size

Saiz Spinde 主轴尺寸

Net Weight

Berat Bersih 淨重

Work Amount (approx.)

Jumlah Kerja 工作量

3.9 - 4.5kg (8.6 - 9.8lbs.)

290m² of area with BL4050F



Cordless Multi Function Power Head

Powerhead Pelbagai Fungsi Tanpa Kord
充电式多功能动力机



Brushcutter
Mesin potong rumput 割草器
EM400MP Part No. 195657-1
EM403MP Part No. 198760-7
*UX01G / DUX60 only

Power brush
Pembersih berus 毛刷清扫器
BR400MP
Part No. 199323-2

Power sweep
Penyapu lantai 地面扫除器
SW400MP
Part No. 199344-4

Ground trimmer
Pemangkas tanaman 地面修剪器
EN420MP (Angle adjustable)
Part No. 198061-3

Hedge trimmer
Pemangkas tanaman 篱笆修剪器
EN410MP (Straight)
Part No. 197742-6

Shaft extension attachment
Penyambung alat 延伸杆
LE400MP Part No. 191E23-0
Length: 1,080mm (42-1/2")
for Pole saw, Pole hedge trimmer
and Coffee harvester

Pole saw
Batang gergaji 高枝链锯
EY401MP Part No. 199925-4
EY403MP Part No. 191T41-8

Edger
Kemasan tepi 草坪修边机具
EE400MP
Part No. 196752-0

Cultivator
Penggembur 耕耘器
KR400MP Part No. 195716-1
KR401MP Part No. 199185-8

Grass Trimmer
Mesin potong rumput 割草器
EM408MP Part No. 191N34-9
EM409MP Part No. 191N46-2

Rotary scissors
Mesin potong rumput 割草器
EM407MP
Part No. 191M57-1

Blower
Penghembus angin 吹风机组
UB400MP Part No. 191F68-4
UB401MP Part No. 191P75-7

Pole hedge trimmer
Pemangkas tanaman 篱笆修剪器
EN401MP (Angle adjustable)
Part No. 196341-1

Max Output

Keluaran Maksima 最大输出

1.0kw

No Load Speed (RPM)

Kelajuan Tanpa Beban 回转数

Dimensions (L x W x H)

Dimensi 体积

Net Weight

Berat Bersih 淨重

High: 0 - 9,700 | Med: 0 - 8,200 |

Low: 0 - 5,700

1,001x320x209mm

(39-1/2x12-5/8x8-1/4")

4.2 - 4.8kg (9.3 - 10.6lbs.)

UX01GZ

RM 2,023

Cordless Multi Function Power Head

Powerhead Pelbagai Fungsi

Tanpa Kord

充电式多功能动力机

• WetGuard and IPX4; Excellent water-resistant performance

Standard Equipment: Shoulder Harness, Hex Wrench, Safety Goggles (195246-2), Accessory Bag

• GZ: Without Charger & Battery



UX01G

VIDEO CLIP
Models and specs may vary by country

* All list price shown are for reference only (exclude SST).

* Semua harga yang ditunjukkan adalah untuk rujukan sahaja (tidak termasuk SST). 所有显示的建议零售价仅供参考 (不包括SST)。



*Compatible batteries

Cordless Hedge Trimmer

Pemangkas Tanaman Pagar Tanpa Kord 充电式篱笆树剪



*Masa Penggunaan Berterusan
连续使用时间

Continuous Usage Time
with BL4040
(Low Speed)

370min
(approx.)

Optimum blade shape for smooth cutting of thin branches

Sharp Edge Curve Blade

UH004G
600mm (23-5/8")

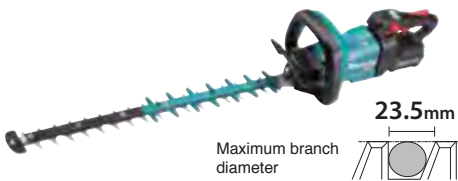

Optimum for rough cutting of thick branches

Sharp Edge Blade

UH006G
600mm (23-5/8")

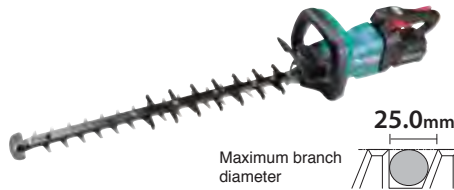
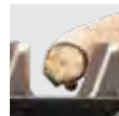

Strokes Per Minute
Kelajuan Strok 冲程速度

5,000 min⁻¹
High Speed Mode

UH006GZ

Price TBA

Cordless Hedge Trimmer
Pemangkas Tanaman Pagar Tanpa Kord
充电式篱笆树剪



*Recommended batteries 2.5Ah, 4.0Ah, 5.0Ah

- Reliable cutting performance like engine/ AC hedge trimmers
- Rough cutting

Standard Equipment: Blade Cover, Chip Receiver

* GZ: Without Charger & Battery



Blade Length Panjang Bilah 刀片长度	600mm (23-5/8")
Strokes Per Minute (SPM) Kelajuan Strok 冲程速度	High / Mid / Low: 4,000 / 3,000 / 2,000
Tooth Spacing Selang Gigi 牙齿间隔	38mm (1-1/2")
Max Cutting Capacity Kapazität Pemotongan Maksimum 最大切割能力	25.0mm (1")
Dimensions (L x W x H) Dimensi 体积	1,123x223x191mm (44-1/2x8-3/4x7-1/2")
Net Weight Berat Bersih 淨重	4.4 - 5.0kg (9.7 - 11.0lbs.)
Continuous Usage Time (approx.) Masa Penggunaan Berterusan 连续使用时间	Low: 195 min Med: 110 min High: 65 min with BL4040

UH004GZ

Price TBA

Cordless Hedge Trimmer
Pemangkas Tanaman Pagar Tanpa Kord
充电式篱笆树剪



*Recommended batteries 2.5Ah, 4.0Ah, 5.0Ah

- Ideal for smoothly and efficiently trimming twigs, thin branches or dense hedges
- Trimming

Standard Equipment: Blade Cover

* GZ: Without Charger & Battery



Blade Length Panjang Bilah 刀片长度	600mm (23-5/8")
Strokes Per Minute (SPM) Kelajuan Strok 冲程速度	High / Mid / Low: 5,000 / 3,600 / 2,000
Tooth Spacing Selang Gigi 牙齿间隔	35mm (1-3/8")
Max Cutting Capacity Kapazität Pemotongan Maksimum 最大切割能力	23.5mm (15/16")
Dimensions (L x W x H) Dimensi 体积	850 - 950x167x297mm (33-1/2-37-1/2x6-9/16x11-3/4")
Net Weight Berat Bersih 淨重	3.1 - 3.9kg (6.8 - 8.6lbs.)
Continuous Usage Time (approx.) Masa Penggunaan Berterusan 连续使用时间	Low: 370 min Med: 160 min High: 85 min with BL4040

* All list price shown are for reference only (exclude SST).

* Semua harga yang ditunjukkan adalah untuk rujukan sahaja (tidak termasuk SST). 所有显示的建议零售价仅供参考 (不包括SST)。

Cordless
Tempat Kerja Tanpa Kabel

LED Flashlight
Lampu Senter LED
- LED BRIGHT

Vacuum Cleaner
Penyedut Debu
- 2.5L

Drilling / Fastening
Gergaji / Pengikat
- 1/2" / 3/8"

Impact Drilling / Demolition
Gergaji / Pecah
- 1/2" / 3/8"

Cutting
Memotong
- 1/2"

Grinding / Smoothing
Mencuci / Mengkilap
- 1/2"

Sawing
Gergaji
- 1/2"

Planing / Routing
Mencuci / Mengkilap
- 1/2"

Others
Lain-lain
- 1/2"

Outdoor Power Equipment
Alat-alat Tenaga Listrik
- 1/2"

40V Li-ion max

XGT

Li-ion Ah 5.0 4.0 2.5 2.0

*Compatible batteries

Cordless Blower

Mesin Penghembus Angin Tanpa Kord 充电式吹风机

Powerful Blowing Force
Kekuatan Tiupan 强大的吹力

20N*

*Boost Mode

Net Weight
Ringan 轻量

3.1 kg

with BL4025 2.5Ah Battery

BL MOTOR
Motor tanpa berus
无碳刷马达

Lightweight design
Improvement in power efficiency makes BL motor more compact and lightweight
Reka bentuk ringan untuk peningkatan kecekapan kuasa menjadikan Motor BL lebih padat dan ringan
用于提高电源效率的轻量化设计使得 BL电机更小巧轻便



3-stage telescopic long nozzle with an adjustment range of 100mm (4")
Muncung panjang teleskopik 3 peringkat dengan jarak penyesuaian 100mm (4")
3级伸缩长喷嘴，调节范围为100mm (4")



WG WET GUARD
Rintangan air yang tinggi
高防水性

High water-resistance allows to operate the machine even if it is wet with water
Mesin dengan rintangan air yang tinggi boleh beroperasi walaupun basah
高防水性机器即使被水弄湿也能运行



UB001GM101 RM 3,730

UB001GZ RM 1,798

Cordless Blower
Mesin Penghembus Angin Tanpa Kord
充电式吹风机

• Compact and lightweight for single handed operation

Standard Equipment: Shoulder Belt (166094-6), End Nozzle (191P97-7), Adapter Pipe (191L96-5), Flat Nozzle (197889-6), Extension nozzle (197888-8)

• GM101: 1x Fast Charger, 1x 4.0Ah Battery
• GZ: Without Charger & Battery

NEW BARU 新

Max Air Volume Isipadu Angin Maksimum 最大风量	Cruise Control Mode: 0 - 13.5 m ³ /min
Max Air Velocity Velositi Angin Maksimum 最大风速	Boost Mode: 16.0 m ³ /min
Blowing Force Kekuatan Tiupan 强大的吹力	Cruise Control Mode: 53 m/s
No Load Speed (RPM) Kelajuan Tanpa Beban 回转数	Boost Mode: 64 m/s
Dimensions (L x W x H) Dimensi 体积	Cruise Control Mode: 0 - 12 N
Net Weight Berat Bersih 净重	Boost Mode: 17 N
Continuous Usage Time (approx.) Masa Penggunaan Berterusan 连续使用时间	Cruise Control Mode: 0 - 20,000
	Boost Mode: 23,000
	Dimensions (L x W x H) (33-1/2-37-1/2x6-9/16x11-3/4")
	Net Weight 3.1 - 3.9kg (6.8 - 8.6lbs.)
	Continuous Usage Time (approx.) Boost mode: 6 min with BL4040

* All list price shown are for reference only (exclude SST).
* Semua harga yang ditunjukkan adalah untuk rujukan sahaja (tidak termasuk SST). 所有显示的建议零售价仅供参考 (不包括SST)。

- Cordless
Tanpa Kord 充电式
- LED Flashlight
Lampu Cahaya LED
LED 闪光灯
- Vacuum Cleaner
Penyedut Vakuum
吸尘器
- Drilling / Fastening
Drool / Pengikat
电钻 / 螺絲起子
- Impact Drilling / Demolition
Drool / Demolisi
冲击钻 / 敲擊工具
- Cutting
Pemotongan
电剪
- Grinding / Sanding
Pengisar / Pasir
砂光机 / 砂纸机
- Sawing
Drool
电锯
- Planing / Routing
Pengelatan / Tumpang
刨花机 / 开槽机
- Others
Lain-lain
其他
- Outdoor Power Equipment
Alatan Kuasa Luar
户外动力工具





Li-ion Ah 6.0 5.0 4.0 3.0 2.0 1.5

Cordless Rotary Hammer

Tukul Putar Tanpa Kord 充电式电钻

Accessories (Optional)

Aksesori 配件



Dust Extractor Attachment Set
Part No. 196536-6



DHR400ZKN 40mm (1-9/16")
RM 5,552

Cordless Rotary Hammer
Tukul Putar Tanpa Kord
充电式电钻



- High power and excellent performance

Standard Equipment: Side Handle, Side Grip, Depth Gauge, Bit Grease (194683-7), Cleaning Cloth

- ZKN: With Carrying Case, Without Charger & Battery



Impact Energy Kekuatan Impak 单次最大锤击力	EPTA-Procedure 05/2009: 8.0J Our experimental conditions: 11.4J
Capacity Kapasiti 能力	Concrete (TCT Bit): 40mm (1-9/16") Concrete (Core Bit): 105mm (4-1/8")
Impacts Per Minute (IPM) Impak Per Minit 冲击数	1,450 - 2,900
No Load Speed (RPM) Kelajuan Tanpa Beban 回转数	250 - 500
Dimensions (L x W x H) Dimensi 体积	473x120x285mm (18-5/8"x4-3/4"x11-1/4")
Net Weight Berat Bersih 净重	7.3 - 8.1kg (16.1 - 17.9lbs.)
Work Amount (approx.) Jumlah Kerja 工作量	25 holes with BL1850B x2 Concrete Grade 40 D18mm x 140mm Depth

Cordless Combination Hammer

Tukul Kombinasi Tanpa Kord 充电式冲击电钻电锤

Accessories (Optional)

Aksesori 配件



HEPA Filter
Part No. 199557-7

Dust cup
Part No. 195173-3

Dust case
Part No. 199555-1

DX08

for DHR280, DHR282

Dust extraction system set
Part No. 199579-7

DHR282PT2J **DHR282Z** 28mm (1-1/8")
RM 3,818 RM 2,233

Cordless Combination Hammer
Tukul Kombinasi Tanpa Kord
充电式冲击电钻电锤



- Auto-start Wireless System (AWS) connects to vacuum cleaner with Bluetooth

Standard Equipment: Side Grip, Depth Gauge, Cleaning Cloth, Bit Grease (194683-7)

- PT2J: 1x Two Port Multi Fast Charger, 2x 5.0Ah Battery, 1x Makpac Connector Box
- Z: Without Charger, Battery & Carrying Case



Impact Energy Kekuatan Impak 单次最大锤击力	EPTA-Procedure 05/2009: 2.8J Our experimental conditions: 3.2J
Capacity Kapasiti 能力	Concrete: 28mm (1-1/8") Steel: 13mm (1/2") Wood: 32mm (1-1/4") Core Bit: 54mm (2-1/8") Diamond Core Bit (Dry Type): 65mm (2-9/16")
Impacts Per Minute (IPM) Impak Per Minit 冲击数	0 - 5,000
No Load Speed (RPM) Kelajuan Tanpa Beban 回转数	0 - 980
Chuck Capacity Kapasiti Chuck 夹头能力	1.5 - 13mm (1/16 - 1/2")
Max Output Keluasan Maksima 最大输出	680W
Dimensions (L x W x H) Dimensi 体积	373x134x232mm (14-3/4"x5-1/4"x9-1/8")
Net Weight Berat Bersih 净重	3.9 - 5.0 kg (8.6 - 11.0 lbs.)
Work Amount (approx.) Jumlah Kerja 工作量	187 holes with BL1850B x2 Concrete Grade 40 D10.5mm x 60mm Depth

DHR280PT2J **DHR280Z** 28mm (1-1/8")
RM 3,632 RM 2,045

Cordless Combination Hammer
Tukul Kombinasi Tanpa Kord
充电式冲击电钻电锤

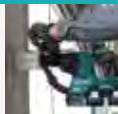

- High Power and Low Vibration

Standard Equipment: Side Grip, Depth Gauge, Cleaning Cloth, Bit Grease (194683-7)

- PT2J: 1x Two Port Multi Fast Charger, 2x 5.0Ah Battery, 1x Makpac Connector Box
- Z: Without Charger, Battery & Carrying Case



Impact Energy Kekuatan Impak 单次最大锤击力	EPTA-Procedure 05/2009: 2.8J Our experimental conditions: 3.2J
Capacity Kapasiti 能力	Concrete: 28mm (1-1/8") Steel: 13mm (1/2") Wood: 32mm (1-1/4") Core Bit: 54mm (2-1/8") Diamond Core Bit (Dry Type): 65mm (2-9/16")
Impacts Per Minute (IPM) Impak Per Minit 冲击数	0 - 5,000
No Load Speed (RPM) Kelajuan Tanpa Beban 回转数	0 - 980
Chuck Capacity Kapasiti Chuck 夹头能力	1.5 - 13mm (1/16 - 1/2")
Max Output Keluasan Maksima 最大输出	680W
Dimensions (L x W x H) Dimensi 体积	373x134x232mm (14-3/4"x5-1/4"x9-1/8")
Net Weight Berat Bersih 净重	3.9 - 4.9 kg (8.6 - 10.8 lbs.)
Work Amount (approx.) Jumlah Kerja 工作量	187 holes with BL1850B x2 Concrete Grade 40 D10.5mm x 60mm Depth

* All list price shown are for reference only (exclude SST).

* Semua harga yang ditunjukkan adalah untuk rujukan sahaja (tidak termasuk SST). 所有显示的建议零售价仅供参考 (不包括SST)。

Cordless
Tempat Kerja
LED Flashlight
Tempat Kerja
LED LIGHT
Vacuum Cleaner
Tempat Kerja
CLEAN
Drilling / Fastening
Galian / Pasang
MUL / PASANG
Impact Drilling / Demolition
Galian / Pasang
MUL / PASANG
Cutting
Galian / Pasang
MUL / PASANG
Grinding / Smoothing
Galian / Pasang
MUL / PASANG
Planing / Routing
Galian / Pasang
MUL / PASANG
Others
MUL / PASANG
Outdoor Power Equipment
MUL / PASANG
Makita
MUL / PASANG



Li-ion Ah 6.0 5.0 4.0 3.0 2.0 1.5

DHR263PM4 RM 4,042 | **DHR263RF4** RM 3,413 | **DHR263Z** 26mm (1") RM 1,798 442 mm

Cordless Combination Hammer

Tukul Kombinasi Tanpa Kord
充电式冲击钻锤



- 3-Mode operation for Rotation Only, Hammering with Rotation or Hammering Only

Standard Equipment: Side Grip, Depth Gauge, Cleaning Cloth, Bit Grease (194683-7)

- PM4: 1x Two Port Multi Fast Charger, 4x 4.0Ah Battery, 1x Tool Bag
- RF4: 1x Rapid Charger, 4x 3.0Ah Battery, 1x Carrying Case
- Z: Without Charger, Battery & Carrying Case



*Not applicable for Z model



DDA460ZK 13mm (1/2") RM 3,790

Cordless Angle Drill
Gerudi Sudut Tanpa Kord
充电式角向电钻



- Powerful drilling even large diameter holes

Standard Equipment: Chuck Key, Hex Wrench, Side Grip

- ZK: With Carrying Case, Without Charger & Battery



DDA460

VIDEO CLIP
Models and specs may vary by country

Impact Energy Kekuatan Impak 单次最大冲击力	EPTA-Procedure 05/2009: 2.5J Our experimental conditions: 3.0J
Capacity Kapasiti 能力	Concrete: 26mm (1") Steel: 13mm (1/2") Wood: 32 mm (1-1/4")
Impacts Per Minute (IPM) Impak Per Minit 冲击数	0 - 5,000
No Load Speed (RPM) Kelajuan Tanpa Beban 回转数	0 - 1,250
Dimensions (L x W x H) Dimensi 体积	350x116x232mm (13-3/4"x4-9/16"x9-1/8")
Net Weight Berat Bersih 净重	4.1 - 5.1kg (9.0 - 11.3lbs)
Work Amount (approx.) Jumlah Kerja 工作量	133 holes with BL1850B x2 Concrete Grade 40 D10.5mm x 60mm Depth

Capacity Kapasiti 能力	Steel: 13mm (1/2") Wood (Self-Feed Bit) Hi: 65mm (2-9/16") Wood (Self-Feed Bit) Lo: 118mm (4-5/8") Wood (Hole Saw) Hi: 105mm (4-1/8") Wood (Hole Saw) Lo: 159mm (6-1/4") Wood (Auger-Bit): 50mm (2")
No Load Speed (RPM) Kelajuan Tanpa Beban 回转数	High: 0 - 1,400 Low: 0 - 350
Max Fastening Torque Maksimum Tenaga Pemutaran Pengancing 最快扭力	High: 48N·m (430 in.lbs.) Low: 136N·m (1,210 in.lbs.)
Max Output Keluaran Maksima 最大输出	1,350 W
Dimensions (L x W x H) Dimensi 体积	538x128x223mm (21-1/4"x5"x8-3/4")
Net Weight Berat Bersih 净重	5.7 - 6.4kg (12.6 - 14.0lbs.)
Work Amount (approx.) Jumlah Kerja 工作量	80 holes with BL1850B x2 2 Layered SPF

Cordless Shear Wrench

Perengkuh Ricih Tanpa Kord 充电式扭断套筒扳手

Accessories (Optional)
Aksesori 配件

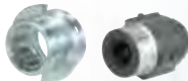

Sleeve size reference table

Pemilihan operasi 3-mod 3模式选择
*Type F (for HEXA TECH (GFD France)) ** for Chinese market

Bolt Size	Outer sleeve		Inner sleeve	
	L (mm)	Part No.	L (mm)	Part No.
M16	35	193804-8	36	195245-4
			36	*764421-7
M16	81	193807-2	82	193810-3
M16	100	764406-3	100	764400-5
M16	200	764407-1	200	764401-3
M20	37	193805-6	38	195217-9
M20	37	**196276-6		
M20	37	193805-6	38	*764422-5
M20	83	193806-4	84	193809-8
M20	100	764408-9	100	764402-1
M20	200	764409-7	200	764403-9

Bolt Size	Outer sleeve		Inner sleeve	
	L (mm)	Part No.	L (mm)	Part No.
M22, 7/8"	39	193960-4	39	195218-7
			39	*764423-3
M22, 7/8"	85	764364-3	85	764352-0
M22, 7/8"	100	764410-2	100	764404-7
M22, 7/8"	170	764365-1	170	764354-6
M22, 7/8"	200	764411-0	200	764405-5
5/8"	35	764362-7	36	764420-9
3/4"	37	764361-9	38	764419-4
3/4"	83	764363-5	84	764353-8
3/4"	168	764366-9	169	764355-4

DWT310ZK M20 (3/4"), M22 (7/8") RM 17,093

Cordless Shear Wrench
Perengkuh Ricih Tanpa Kord
充电式扭断套筒扳手



- Up to 14% Faster Fastening than Corded Model 6922NB

Standard Equipment: Screwdriver, Shoulder Belt, M20 Sleeve, M22 Sleeve

- ZK: With Carrying Case, Without Charger & Battery



Capacity Kapasiti 能力	High Strength Torque Shear Bolt (HTB): M16 (optional), M20, M22 (5/8", 3/4", 7/8") Super High Strength Torque Shear Bolt (SHTB): M16, M20 (5/8", 3/4")
No Load Speed (RPM) Kelajuan Tanpa Beban 回转数	14
Max Fastening Torque Maksimum Tenaga Pemutaran Pengancing 最快扭力	804N·m (593ft.lbs.)
Dimensions (L x W x H) Dimensi 体积	296x130x377mm (11-5/8"x5-1/8"x14-7/8")
Net Weight Berat Bersih 净重	6.5 - 7.1kg (14.3 - 15.7lbs.)
Work Amount (approx.) Jumlah Kerja 工作量	300 pcs with BL1850B x2 M22 (7/8") Torque Shear Bolts

* All list price shown are for reference only (exclude SST).

* Semua harga yang ditunjukkan adalah untuk rujukan sahaja (tidak termasuk SST). 所有显示的建议零售价仅供参考 (不包括SST)。

Cordless Target Kordless
LED Flashlight Lampu Cahaya LED
Vacuum Cleaner Penyedut Vakuum
Drilling / Fastening
Impact Drilling / Demolition
Cutting
Grinding / Sanding
Sawing
Planing / Routing
Others





Li-ion Ah 6.0 5.0 4.0 3.0 2.0 1.5



Cordless Angle Grinder

Pengisar Sudut Tanpa Kord 充电式角向磨光机

DGA701Z 180mm (7")
RM 1,795

Cordless Angle Grinder
Pengisar Sudut Tanpa Kord
充电式角向磨光机



- Auto-start Wireless System (AWS) connects to vacuum cleaner with Bluetooth



Standard Equipment: Wheel Cover, Side Grip, Lock Nut Wrench

• Z: Without Charger & Battery



Wheel Diameter Diameter Mata Canai 砂轮片直径	180mm (7")
Hole Diameter Diameter Lubang 孔直径	22.23mm (7/8")
Max Wheel Thickness Ketebalan Roda 轮片厚度	7.2 mm (1/4")
No Load Speed (RPM) Kelajuan Tanpa Beban 回转数	7,800
Max Output Keluasan Maksima 最大输出	1,500W
Dimensions (L x W x H) Dimensi 体积	499x200x158mm (19-5/8"x7-7/8"x6-1/4")
Net Weight Berat Bersih 净重	5.0 - 6.0kg (11.0 - 13.3lbs.)
Work Amount (approx.) Jumlah Kerja 工作量	17 cuts with BL1850B x2 Equiangular Angle Steel 50 x 50mm

DGA700Z 180mm (7")
RM 1,605

Cordless Angle Grinder
Pengisar Sudut Tanpa Kord
充电式角向磨光机



- Electric brake stops the grinding wheel in 4.5 seconds or less for increased operator safety



Standard Equipment: Wheel Cover, Side Grip, Lock Nut Wrench

• Z: Without Charger & Battery



Wheel Diameter Diameter Mata Canai 砂轮片直径	180mm (7")
No Load Speed (RPM) Kelajuan Tanpa Beban 回转数	7,800
Dimensions (L x W x H) Dimensi 体积	499x200x158mm (19-5/8"x7-7/8"x6-1/4")
Net Weight Berat Bersih 净重	5.0 - 6.0kg (11.02 - 13.23lbs)
Work Amount (approx.) Jumlah Kerja 工作量	17 cuts with BL1850B x2 Equiangular Angle Steel 50 x 50mm

DGA901Z 230mm (9")
RM 1,810

Cordless Angle Grinder
Pengisar Sudut Tanpa Kord
充电式角向磨光机



- Auto-start Wireless System (AWS) connects to vacuum cleaner with Bluetooth



Standard Equipment: Wheel Cover, Side Grip, Lock Nut Wrench

• Z: Without Charger & Battery



Wheel Diameter Diameter Mata Canai 砂轮片直径	230mm (9")
Hole Diameter Diameter Lubang 孔直径	22.23mm (7/8")
Max Wheel Thickness Ketebalan Roda 轮片厚度	6.5mm (1/4")
No Load Speed (RPM) Kelajuan Tanpa Beban 回转数	6,000
Max Output Keluasan Maksima 最大输出	1,500W
Dimensions (L x W x H) Dimensi 体积	499x250x158mm (19-5/8"x9-7/8"x6-1/4")
Net Weight Berat Bersih 净重	5.2 - 8.0kg (11.46 - 17.64lbs.)
Work Amount (approx.) Jumlah Kerja 工作量	17 cuts with BL1850B x2 Equiangular Angle Steel 50 x 50mm

DGA900Z 230mm (9")
RM 1,623

Cordless Angle Grinder
Pengisar Sudut Tanpa Kord
充电式角向磨光机

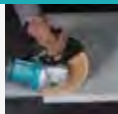

- Electric brake stops the grinding wheel in 4.5 seconds or less for increased operator safety



Standard Equipment: Wheel Cover, Side Grip, Lock Nut Wrench

• Z: Without Charger & Battery



Wheel Diameter Diameter Mata Canai 砂轮片直径	230mm (9")
No Load Speed (RPM) Kelajuan Tanpa Beban 回转数	6,000
Dimensions (L x W x H) Dimensi 体积	499x250x158mm (19-5/8"x9-7/8"x6-1/4")
Net Weight Berat Bersih 净重	5.2 - 8.0kg (11.46 - 17.71lbs.)
Work Amount (approx.) Jumlah Kerja 工作量	17 cuts with BL1850B x2 Equiangular Angle Steel 50 x 50mm

* All list price shown are for reference only (exclude SST).

* Semua harga yang ditunjukkan adalah untuk rujukan sahaja (tidak termasuk SST). 所有显示的建议零售价仅供参考 (不包括SST)。

Cordless
Tempat Kerja
LED Flashlight
Tempat Kerja LED
LED BRIGHT
Vacuum Cleaner
Penyedut Debu
BLU
Drilling / Fastening
Galian / Pasang
MIL / BUL
Impact Drilling / Demolition
Galian / Pecutan
MIL / BUL
Cutting
Potong
MIL
Grinding / Smoothing
Giling / Rata
MIL / BUL
Sawing
Gigit
MIL
Planing / Routing
Pajuan / Tuguan
MIL / BUL
Others
Lain-lain
MIL
Outdoor Power Equipment
Alatan Kuat Daya
MIL / BUL
Makita
MIL



Li-ion Ah 6.0 5.0 4.0 3.0 2.0 1.5

DSP601Z | **DSP600Z** 165mm (6-1/2")
RM 3,273 | RM 2,678

Cordless Plunge Cut Saw
Pensidar Sudut Tanpa Kord
充电式角向磨光机



- Auto-start Wireless System (AWS) connects to vacuum cleaner with Bluetooth

Standard Equipment: TCT Saw Blade (B-57364), Hex Wrench

- Z: Without Charger & Battery

ONLY FOR
DSP601



Blade Diameter Diameter Bilah 锯片直径	165mm (6-1/2")
Bevel Capacity Kapasiti Bevel 斜角容量	-1° - 48°
Max Cutting Capacity Kapasiti Pemotongan Maksimum 最大切割能力	90°: 56mm (2-3/16") 45°: 40 mm (1-9/16") 48°: 38 mm (1-1/2")
No Load Speed (RPM) Kelajuan Tanpa Beban 回转速数	2,500 - 6,300
Dimensions (L x W x H) Dimensi 体积	346x241x272mm (13-5/8"x9-1/2"x10-3/4")
Net Weight Berat Bersih 淨重	4.4 - 5.1kg (9.8 - 11.2lbs.)
Work Amount (approx.) Jumlah Kerja 工作量	48 cuts with BL1850B x2 Melamine Board 32mm (Thick) x 1000mm (Length)

Cordless Slide Compound Miter Saw

Gergaji Kompaun Miter Tanpa Kord 充电式斜断锯



DLS211Z 305mm (12")
RM 6,132

Cordless Slide Compound Miter Saw
Gergaji Kompaun Miter Tanpa Kord
充电式斜断锯



- Auto-start Wireless System (AWS) connects to vacuum cleaner with Bluetooth

Standard Equipment: TCT Saw Blade (B-67452), Dust Bag (1228520), Triangular Rule, Vertical Vise, Hex Wrench

- Z: Without Charger & Battery



Blade Diameter Diameter Bilah 锯片直径	305mm (12")
Miter Angle Sudut Miter 斜接角	60°L / 60°R
Bevel Angle Sudut Bevel 斜角	48°L / 48°R
Max Cutting Capacity Kapasiti Pemotongan Maksimum 最大切割能力	90°Miter: 107 x 363mm (4-1/4" x 14-1/4") 90° Miter: 92 x 382mm (3-5/8" x 15") 45° Miter, L/R: 107 x 255mm (4-1/4" x 10") 45° Miter, L/R: 92 x 268mm (3-5/8" x 10-1/2")
No Load Speed (RPM) Kelajuan Tanpa Beban 回转速数	4,400
Dimensions (L x W x H) Dimensi 体积	898x690x725mm (35-1/4"x27-1/4"x28-1/2")
Net Weight Berat Bersih 淨重	30.7 - 31.3kg (67.6 - 69.1lbs.)

DLS111Z 260mm (10-1/4")
RM 5,353

Cordless Slide Compound Miter Saw
Gergaji Kompaun Miter Tanpa Kord
充电式斜断锯



- Auto-start Wireless System (AWS) connects to vacuum cleaner with Bluetooth

Standard Equipment: TCT Saw Blade (B-64668), Dust Bag (1228520), Triangular Rule, Vertical Vise, Hex Wrench

- Z: Without Charger & Battery



Blade Diameter Diameter Bilah 锯片直径	260mm (10-1/4")
Miter Angle Sudut Miter 斜接角	60°L / 60°R
Bevel Angle Sudut Bevel 斜角	48°L / 48°R
Max Cutting Capacity Kapasiti Pemotongan Maksimum 最大切割能力	90° Miter: 91 x 279mm (3-5/8" x 11") 90° Miter: 68 x 310mm (2-11/16" x 12-1/4") 45° Miter, L/R: 91 x 197mm (3-5/8" x 7-3/4") 45° Miter, L/R: 68 x 218mm (2-11/16" x 8-5/8")
No Load Speed (RPM) Kelajuan Tanpa Beban 回转速数	4,400
Dimensions (L x W x H) Dimensi 体积	805x644x660mm (31-3/4"x25-3/8"x26")
Net Weight Berat Bersih 淨重	26.6 - 27.3kg (58.6 - 60.2 lbs.)

DLS714PM2 | **DLS714Z** 190mm (7-1/2")
RM 5,813 | RM 4,373

Cordless Slide Compound Miter Saw
Gergaji Kompaun Miter Tanpa Kord
充电式斜断锯

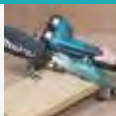

- Large cutting capacity; Crosscuts up to 52 x 300 mm (2-1/16" x 11-3/4") at 90°

Standard Equipment: TCT Saw Blade (B-03850), Dust Bag (1228520), Holder Set, Vertical Vise, Hex Wrench, Triangular Rule

- PM2: 1x Two Port Multi Fast Charger, 2x 4.0Ah Battery
- Z: Without Charger & Battery



Blade Diameter Diameter Bilah 锯片直径	190mm (7-1/2")
Miter Angle Sudut Miter 斜接角	47°L / 57°R
Bevel Angle Sudut Bevel 斜角	45°L / 5°R
Max Cutting Capacity Kapasiti Pemotongan Maksimum 最大切割能力	90°: 52 x 300mm (2-1/16" x 11-3/4") at 45° left: 40 x 300mm (1-9/16" x 11-3/4") at 5° right: 40 x 300mm (1-9/16" x 11-3/4")
No Load Speed (RPM) Kelajuan Tanpa Beban 回转速数	5,700
Dimensions (L x W x H) Dimensi 体积	655x430x445mm (25-3/4"x17"x17-1/2")
Net Weight Berat Bersih 淨重	12.6kg (27.8lbs)
Work Amount (approx.) Jumlah Kerja 工作量	350 pcs with BL1850B x2 SPF Material 2x4"

* All list price shown are for reference only (exclude SST).

* Semua harga yang ditunjukkan adalah untuk rujukan sahaja (tidak termasuk SST). 所有显示的建议零售价仅供参考 (不包括SST)。



Li-ion Ah 6.0 5.0 4.0 3.0 2.0 1.5

DJR360RF4 DJR360Z
RM 3,382 RM 1,768

Cordless Recipro Saw
Gergaji Resipro Tanpa Kord
充电式往复锯



- Electric 2 speed provides ideal RPM of high speed for wooden cutting and low speed for metal cutting



Standard Equipment: Recipro Saw Blades 2pcs (B-05175 & B-05169)

- RF4: 1x Rapid Charger, 4x 3.0Ah Battery
- Z: Without Charger, Battery & Carrying Case

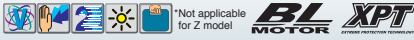

Length of Stroke Panjang Strok 冲程长度	32mm (1-1/4")
Strokes Per Minute (SPM) Kelajuan Strok 冲程速度	High: 0 - 3,000 Low: 0 - 2,300
Capacity Kapasiti 能力	Pipe: 130mm (5-1/8") Wood: 255mm (10")
Dimensions (L x W x H) Dimensi 体积	449x116x243mm (17-3/4"x4-9/16"x9-9/16")
Net Weight Berat Bersih 淨重	4.0 - 4.7kg (8.9 - 10.3lbs)
Work Amount (approx.) Jumlah Kerja 工作量	110 pcs with BL1850B x2 Steel Pipe (φ34 x 3mm)

Cordless Portable Cut-off

Mesin Pemotong Tanpa Kord 充电式无刷轻钢架砂轮切断机

CUTTING CAPACITY

A workpiece thinner than 1.6mm is recommended for cutting with this tool

Form of Materials	Diagram	Diagram	Diagram	Diagram
Miter Angle 0°	D: ø127mm (5")	H x W: 115 x 130 (4-1/2"x5-1/8") 102 x 194mm (4"x7-5/8") 70 x 233mm (2-3/4"x9-1/8")	H x W: 119 x 119mm (4-11/16"x4-11/16")	S x S: 137 x 137mm (5-3/8"x5-3/8")
Miter Angle 45°	D: ø127mm (5")	H x W: 115 x 103mm (4-1/2"x4-1/16")	H x W: 106 x 106mm (4-3/16"x4-3/16")	S x S: 100 x 100mm (4"x4")

D: Diameter | W: Width | H: Height | S: Side

DLW140Z 355mm (14")
RM 2,423

Cordless Portable Cut-off
Mesin Pemotong Tanpa Kord
充电式无刷轻钢架砂轮切断机



- World's First Cordless Portable Cut-off



Standard Equipment:
Cut-Off Wheel (B-64696)

- Z: Without Charger & Battery



VIDEO CLIP
Models and specs may vary by country

Wheel Diameter Diameter Mata Canai 砂轮片直径	355mm (14")
Hole Diameter Diameter Lubang 孔直径	25.4mm (1")
Max Wheel Thickness Ketebalan Roda 轮片厚度	3mm (1/8")
No Load Speed (RPM) Kelajuan Tanpa Beban 回转数	3,800
Capacity at 90° Kapasiti Pemotongan 切割能力	Round: 127mm (5") Rectangular: 115x130mm (4-1/2"x5-1/8") Rectangular: 102x194mm (4"x7-5/8") Rectangular: 70x233mm (2-3/4"x9-1/8")
Capacity at 45° Kapasiti Pemotongan 切割能力	Round: 127mm (5") Rectangular: 115x103mm (4-1/2"x4-1/16")
Dimensions (L x W x H) Dimensi 体积	537x280x640mm (21-1/8"x11"x25-1/4")
Net Weight Berat Bersih 淨重	17.2 - 17.8kg (37.9 - 39.3lbs.)
Work Amount (approx.) Jumlah Kerja 工作量	130 cuts with BL1850B x2 Metal Stud (H:75mm, W: 45mm, T: 0.8mm)

DRS780Z 185mm (7-1/4")
RM 1,905

Cordless Rear Handle Saw
Gergaji Piring Tanpa Kord
充电式后把手圆锯



- Cuts 3X Material in a Single Pass;
Blade Left Design



Standard Equipment: TCT Saw Blade (B-62022), Offset Wrench

- Z: Without Charger & Battery



Blade Diameter Diameter Bilah 锯片直径	185mm (7-1/4")
Max Cutting Capacity Kapasiti Pemotongan Maksimum 最大切割能力	90°: 65mm (2-9/16") 45°: 45mm (1-3/4") 53°: 38mm (1-1/2")
No Load Speed (RPM) Kelajuan Tanpa Beban 回转数	5,100
Dimensions (L x W x H) Dimensi 体积	446x196x270mm (17-1/2"x7-3/4"x10-5/8")
Net Weight Berat Bersih 淨重	5.0 - 5.6kg (11.1 - 12.4lbs.)

DHS710RM2J DHS710RF2J 190mm (7-1/2")
RM 2,568 RM 2,405

Cordless Circular Saw
Gergaji Piring Tanpa Kord
充电式圆锯



- Lightweight for operator comfort



Standard Equipment: TCT Saw Blade (D-09123), Rip Fence (Guide Rule), Hex Wrench

- RM2J: 1x Rapid Charger, 2x 4.0Ah Battery, 1x Makpac Connector Box
- RF2J: 1x Rapid Charger, 2x 3.0Ah Battery, 1x Makpac Connector Box



VIDEO CLIP
Models and specs may vary by country

Blade Diameter Diameter Bilah 锯片直径	190/185mm (7-1/2"/7-1/4")
Max Cutting Capacity Kapasiti Pemotongan Maksimum 最大切割能力	90°: 68.5/66mm (2-11/16"/2-5/8") 45°: 49/47.5mm (1-15/16"/1-7/8") 50°: 44/42.5mm (1-3/4"/1-11/16") 4,800
No Load Speed (RPM) Kelajuan Tanpa Beban 回转数	4,800
Dimensions (L x W x H) Dimensi 体积	356x217x298mm (14"x8-1/2"x11-3/4")
Net Weight Berat Bersih 淨重	3.9 - 4.6kg (8.6 - 10.1lbs)
Work Amount (approx.) Jumlah Kerja 工作量	205 pcs with BL1850B x2 SPF 2 x 10 (thickness 38mm, width 235mm), 90° cut

* All list price shown are for reference only (exclude SST).

* Semua harga yang ditunjukkan adalah untuk rujukan sahaja (tidak termasuk SST). 所有显示的建议零售价仅供参考 (不包括SST)。

Cordless
Tempat Kerja
Tempat Kerja

LED Flashlight
Lampu Senter LED
LED LIGHT

Vacuum Cleaner
Penyedut Debu
VACUUM

Drilling / Fastening
Gergaji / Pengikat
DRILL / FASTEN

Impact Drilling / Demolition
Gergaji / Pecutah
IMPACT DRILL / DEMO

Cutting
Pemotongan
CUT

Grinding / Sanding
Gergaji / Pasut
GRIND / SAND

Sawing
Gergaji
SAW

Planing / Routing
Pajuan / Tebang
PLAN / ROUT

Others
Lain-lain
OTHER

Outdoor Power Equipment
Alatan Kuat Daya
OUTDOOR POWER

Others
Lain-lain
OTHER

Makita
MAKITA



Li-ion Ah 6.0 | 5.0 | 4.0 | 3.0 | 2.0 | 1.5

Cordless Circular Saw

Gergaji Piring Tanpa Kord 充电式圆锯

Lightweight
Ringan 轻量

6.0kg

with BL1860B x2
6.0Ah Battery

Variable speed control by dial

Kawalan kelajuan berubah dengan dial 拨盘变速控制



Battery capacity warning lamp

Blower function

Fungsi Peniup 吹风功能



Twin LED Job light

Lampu kerja LED LED工作灯



Bevel cuts up to 1° left and 60° right

Potongan serong 1° kiri dan 60° kanan
斜切左 1° / 右 60°



DHS900PT2 | **DHS900Z** 235mm (9-1/4")
RM 5,645 | RM 4,060

Cordless Circular Saw
Gergaji Piring Tanpa Kord
充电式圆锯



- Auto-start Wireless System (AWS) connects to vacuum cleaner with Bluetooth

Standard Equipment: TCT Saw Blade (E-01959), Sub Base, Hex Wrench

- PT2: 1x Two Port Multi Fast Charger, 2x 5.0Ah Battery
- Z: Without Charger, Battery & Carrying Case



Blade Diameter Diameter Bilah 锯片直径	235mm (9-1/4")
Hole Diameter Diameter Lubang 孔直径	15.88mm (5/8") 25mm (1") 25.4mm (1") 30mm (1-3/16")
Max Cutting Capacity Kapasiti Pemotongan Maksimum 最大切割能力	90°: 85mm (3-3/8") 45°: 61mm (2-3/8") 60°: 44mm (1-3/4")
No Load Speed (RPM) Kelajuan Tanpa Beban 回转数	4,500
Dimensions (L x W x H) Dimensi 体积	413x196x316mm (16-1/4"x7-3/4"x12-1/2")
Net Weight Berat Bersih 净重	5.3 - 6.0kg (11.7 - 13.2lbs.)

DHS782Z 190mm (7-1/2") / 185mm (7-1/4")
RM 2,943

Cordless Circular Saw
Gergaji Piring Tanpa Kord
充电式圆锯



- Overload alert using ADT lamp

Standard Equipment: TCT Saw Blade, Dust Nozzle, Hex Wrench, Guide Rule

- Z: Without Charger & Battery



Blade Diameter Diameter Bilah 锯片直径	190mm (7 - 1/2") 185mm (7 - 1/4")
Hole Diameter Diameter Lubang 孔直径	15.88mm (5/8") 20mm (13/16") 30mm (1-3/16")
Max Cutting Capacity Kapasiti Pemotongan Maksimum 最大切割能力	90°: 62.5/ 60mm (2-7/16"/ 2-3/8") 45°: 44.5/ 43mm (1-3/4"/ 1-11/16") 48°: 42/ 41mm (1-5/8"/ 1-5/8")
No Load Speed (RPM) Kelajuan Tanpa Beban 回转数	6,000
Max Output Keluaran Maksima 最大输出	1,800W
Dimensions (L x W x H) Dimensi 体积	348x210x290mm (13-3/4"x8-1/4"x11-3/8")
Net Weight Berat Bersih 净重	4.5 - 5.1kg (9.9 - 11.3lbs.)



DHS782Z
Models and specs may vary by country

DHS783Z 190mm (7-1/2") / 185mm (7-1/4")
RM 3,228

Cordless Circular Saw
Gergaji Piring Tanpa Kord
充电式圆锯



- Auto-start Wireless System (AWS) connects to vacuum cleaner with Bluetooth

Standard Equipment: TCT Saw Blade (B-62022), Hex Wrench, Guide Rule, Dust Nozzle

- Z: Without Charger & Battery



Blade Diameter Diameter Bilah 锯片直径	190mm (7 - 1/2") 185mm (7 - 1/4")
Hole Diameter Diameter Lubang 孔直径	15.88mm (5/8") 20mm (13/16") 30mm (1-3/16")
Max Cutting Capacity Kapasiti Pemotongan Maksimum 最大切割能力	90°: 62.5/ 60mm (2-7/16"/ 2-3/8") 45°: 44.5/ 43mm (1-3/4"/ 1-11/16") 48°: 42/ 41mm (1-5/8"/ 1-5/8")
No Load Speed (RPM) Kelajuan Tanpa Beban 回转数	6,000
Max Output Keluaran Maksima 最大输出	1,800W
Dimensions (L x W x H) Dimensi 体积	348x210x290mm (13-3/4"x8-1/4"x11-3/8")
Net Weight Berat Bersih 净重	4.5 - 5.1kg (9.9 - 11.3lbs.)



DHS783Z
Models and specs may vary by country

* All list price shown are for reference only (exclude SST).

* Semua harga yang ditunjukkan adalah untuk rujukan sahaja (tidak termasuk SST). 所有显示的建议零售价仅供参考 (不包括SST)。

Cordless
Target Kordless
LED Flashlight
Lampu Cahaya LED
LEDBRIGHT
Vacuum Cleaner
Penyedut Vakum
BLUCH
Drilling / Fastening
Drovo / Pasang
M10 / M8
Impact Drilling / Demolition
Drovo / Demoli
M10 / M8
Cutting
Pemotongan
M10
Grinding / Sanding
Tungku / Pasang
M10 / M8
Sawing
Drovo
M10
Planing / Routing
Tungku / Pasang
M10 / M8
Drivers
Lampu
M10
Outdoor Power Equipment
Alat Kuasa Luar
M10 - 7.6





Li-ion Ah 6.0 5.0 4.0 3.0 2.0 1.5



*Jumlah Kerja 工作量
Work Amount
 with BL1860 x2
 (ø150mm, 600mm depth)
155 holes
 (approx.)

Cordless Earth Auger

Mesin Gerudi Tanah Tanpa Kord 充电式无刷弯角度地钻头



Reversing switch

enables to extract, in reverse rotation mode, an auger bit jammed in soil with high resistance like clay soil.



Suis putaran terbalik dalam mod putaran terbalik dapat mengeluarkan bit auger yang tersumbat dalam tanah yang berintang tinggi seperti tanah liat.
 反向开关可在反向旋转模式下提取堵塞在高阻力土壤如粘土中的螺旋钻头



Torque limiter

The torque limiter will actuate when a certain torque level is reached at the low speed setting.

The motor will disengage from the output shaft. When this happens, the drill bit will stop turning.

Pembatas tork akan aktif apabila tahap tork tertentu dicapai pada tetapan kelajuan rendah. Motor akan terlepas dari output syaf. Apabila ini berlaku, bit gerudi akan berhenti berpusing.

扭矩限制器在低速设置下达到一定扭矩水平时，扭矩限制器将启动。马达将与输出轴分离。发生这种情况时，钻头将停止旋转。

Light weight

Ringan 轻量

8.2kg

with BL1860B x2
6.0Ah Battery



For larger holes
 Untuk lubang yang lebih besar 对于更大的孔



DDG460ZX7

RM 5,252

Cordless Earth Auger

Mesin Gerudi Tanah Tanpa Kord
 充电式弯角度地钻头

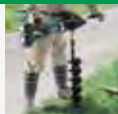

• Auger bit adapter enables to use the auger bits for popular engine earth augers

Standard Equipment:

Chuck Key, Hex Wrench x3 Types, Adapter A (327684-2), Adapter D (327687-6), Handle Set

• ZX7: Without Charger & Battery



Capacity Kapasiti 能力	Sandy Soil: 200mm Clay Soil: 150mm
Chuck Capacity Kapasiti Chuck 夹头能力	2 - 13mm (5/64 - 1/2")
No Load Speed (RPM) Kelajuan Tanpa Beban 回转速	High: 0 - 1,400 Low: 0 - 350
Max Fastening Torque Pemutaran Tenaga Maksimum 最大扭矩	High: 48N-m (430in.lbs.) Low: 136N-m (1,210in.lbs.)
Dimensions (L x W x H) Dimensi 体积	840x607x223mm (33x23-7/8x8-3/4")
Net Weight Berat Bersin 净重	7.3 - 8.2kg (16.1 - 18.1lbs.)
Work Amount (approx.) Jumlah Kerja 工作量	155 holes with BL1860B x2 ø150 mm, 600 mm depth

* All list price shown are for reference only (exclude SST).

* Semua harga yang ditunjukkan adalah untuk rujukan sahaja (tidak termasuk SST). 所有显示的建议零售价仅供参考 (不包括SST)。

Cordless
 Tempa Masa 10/15/20/25/30/35/40/45/50/55/60/65/70/75/80/85/90/95/100/105/110/115/120/125/130/135/140/145/150/155/160/165/170/175/180/185/190/195/200/205/210/215/220/225/230/235/240/245/250/255/260/265/270/275/280/285/290/295/300/305/310/315/320/325/330/335/340/345/350/355/360/365/370/375/380/385/390/395/400/405/410/415/420/425/430/435/440/445/450/455/460/465/470/475/480/485/490/495/500/505/510/515/520/525/530/535/540/545/550/555/560/565/570/575/580/585/590/595/600/605/610/615/620/625/630/635/640/645/650/655/660/665/670/675/680/685/690/695/700/705/710/715/720/725/730/735/740/745/750/755/760/765/770/775/780/785/790/795/800/805/810/815/820/825/830/835/840/845/850/855/860/865/870/875/880/885/890/895/900/905/910/915/920/925/930/935/940/945/950/955/960/965/970/975/980/985/990/995/1000/1005/1010/1015/1020/1025/1030/1035/1040/1045/1050/1055/1060/1065/1070/1075/1080/1085/1090/1095/1100/1105/1110/1115/1120/1125/1130/1135/1140/1145/1150/1155/1160/1165/1170/1175/1180/1185/1190/1195/1200/1205/1210/1215/1220/1225/1230/1235/1240/1245/1250/1255/1260/1265/1270/1275/1280/1285/1290/1295/1300/1305/1310/1315/1320/1325/1330/1335/1340/1345/1350/1355/1360/1365/1370/1375/1380/1385/1390/1395/1400/1405/1410/1415/1420/1425/1430/1435/1440/1445/1450/1455/1460/1465/1470/1475/1480/1485/1490/1495/1500/1505/1510/1515/1520/1525/1530/1535/1540/1545/1550/1555/1560/1565/1570/1575/1580/1585/1590/1595/1600/1605/1610/1615/1620/1625/1630/1635/1640/1645/1650/1655/1660/1665/1670/1675/1680/1685/1690/1695/1700/1705/1710/1715/1720/1725/1730/1735/1740/1745/1750/1755/1760/1765/1770/1775/1780/1785/1790/1795/1800/1805/1810/1815/1820/1825/1830/1835/1840/1845/1850/1855/1860/1865/1870/1875/1880/1885/1890/1895/1900/1905/1910/1915/1920/1925/1930/1935/1940/1945/1950/1955/1960/1965/1970/1975/1980/1985/1990/1995/2000/2005/2010/2015/2020/2025/2030/2035/2040/2045/2050/2055/2060/2065/2070/2075/2080/2085/2090/2095/2100/2105/2110/2115/2120/2125/2130/2135/2140/2145/2150/2155/2160/2165/2170/2175/2180/2185/2190/2195/2200/2205/2210/2215/2220/2225/2230/2235/2240/2245/2250/2255/2260/2265/2270/2275/2280/2285/2290/2295/2300/2305/2310/2315/2320/2325/2330/2335/2340/2345/2350/2355/2360/2365/2370/2375/2380/2385/2390/2395/2400/2405/2410/2415/2420/2425/2430/2435/2440/2445/2450/2455/2460/2465/2470/2475/2480/2485/2490/2495/2500/2505/2510/2515/2520/2525/2530/2535/2540/2545/2550/2555/2560/2565/2570/2575/2580/2585/2590/2595/2600/2605/2610/2615/2620/2625/2630/2635/2640/2645/2650/2655/2660/2665/2670/2675/2680/2685/2690/2695/2700/2705/2710/2715/2720/2725/2730/2735/2740/2745/2750/2755/2760/2765/2770/2775/2780/2785/2790/2795/2800/2805/2810/2815/2820/2825/2830/2835/2840/2845/2850/2855/2860/2865/2870/2875/2880/2885/2890/2895/2900/2905/2910/2915/2920/2925/2930/2935/2940/2945/2950/2955/2960/2965/2970/2975/2980/2985/2990/2995/3000/3005/3010/3015/3020/3025/3030/3035/3040/3045/3050/3055/3060/3065/3070/3075/3080/3085/3090/3095/3100/3105/3110/3115/3120/3125/3130/3135/3140/3145/3150/3155/3160/3165/3170/3175/3180/3185/3190/3195/3200/3205/3210/3215/3220/3225/3230/3235/3240/3245/3250/3255/3260/3265/3270/3275/3280/3285/3290/3295/3300/3305/3310/3315/3320/3325/3330/3335/3340/3345/3350/3355/3360/3365/3370/3375/3380/3385/3390/3395/3400/3405/3410/3415/3420/3425/3430/3435/3440/3445/3450/3455/3460/3465/3470/3475/3480/3485/3490/3495/3500/3505/3510/3515/3520/3525/3530/3535/3540/3545/3550/3555/3560/3565/3570/3575/3580/3585/3590/3595/3600/3605/3610/3615/3620/3625/3630/3635/3640/3645/3650/3655/3660/3665/3670/3675/3680/3685/3690/3695/3700/3705/3710/3715/3720/3725/3730/3735/3740/3745/3750/3755/3760/3765/3770/3775/3780/3785/3790/3795/3800/3805/3810/3815/3820/3825/3830/3835/3840/3845/3850/3855/3860/3865/3870/3875/3880/3885/3890/3895/3900/3905/3910/3915/3920/3925/3930/3935/3940/3945/3950/3955/3960/3965/3970/3975/3980/3985/3990/3995/4000/4005/4010/4015/4020/4025/4030/4035/4040/4045/4050/4055/4060/4065/4070/4075/4080/4085/4090/4095/4100/4105/4110/4115/4120/4125/4130/4135/4140/4145/4150/4155/4160/4165/4170/4175/4180/4185/4190/4195/4200/4205/4210/4215/4220/4225/4230/4235/4240/4245/4250/4255/4260/4265/4270/4275/4280/4285/4290/4295/4300/4305/4310/4315/4320/4325/4330/4335/4340/4345/4350/4355/4360/4365/4370/4375/4380/4385/4390/4395/4400/4405/4410/4415/4420/4425/4430/4435/4440/4445/4450/4455/4460/4465/4470/4475/4480/4485/4490/4495/4500/4505/4510/4515/4520/4525/4530/4535/4540/4545/4550/4555/4560/4565/4570/4575/4580/4585/4590/4595/4600/4605/4610/4615/4620/4625/4630/4635/4640/4645/4650/4655/4660/4665/4670/4675/4680/4685/4690/4695/4700/4705/4710/4715/4720/4725/4730/4735/4740/4745/4750/4755/4760/4765/4770/4775/4780/4785/4790/4795/4800/4805/4810/4815/4820/4825/4830/4835/4840/4845/4850/4855/4860/4865/4870/4875/4880/4885/4890/4895/4900/4905/4910/4915/4920/4925/4930/4935/4940/4945/4950/4955/4960/4965/4970/4975/4980/4985/4990/4995/5000/5005/5010/5015/5020/5025/5030/5035/5040/5045/5050/5055/5060/5065/5070/5075/5080/5085/5090/5095/5100/5105/5110/5115/5120/5125/5130/5135/5140/5145/5150/5155/5160/5165/5170/5175/5180/5185/5190/5195/5200/5205/5210/5215/5220/5225/5230/5235/5240/5245/5250/5255/5260/5265/5270/5275/5280/5285/5290/5295/5300/5305/5310/5315/5320/5325/5330/5335/5340/5345/5350/5355/5360/5365/5370/5375/5380/5385/5390/5395/5400/5405/5410/5415/5420/5425/5430/5435/5440/5445/5450/5455/5460/5465/5470/5475/5480/5485/5490/5495/5500/5505/5510/5515/5520/5525/5530/5535/5540/5545/5550/5555/5560/5565/5570/5575/5580/5585/5590/5595/5600/5605/5610/5615/5620/5625/5630/5635/5640/5645/5650/5655/5660/5665/5670/5675/5680/5685/5690/5695/5700/5705/5710/5715/5720/5725/5730/5735/5740/5745/5750/5755/5760/5765/5770/5775/5780/5785/5790/5795/5800/5805/5810/5815/5820/5825/5830/5835/5840/5845/5850/5855/5860/5865/5870/5875/5880/5885/5890/5895/5900/5905/5910/5915/5920/5925/5930/5935/5940/5945/5950/5955/5960/5965/5970/5975/5980/5985/5990/5995/6000/6005/6010/6015/6020/6025/6030/6035/6040/6045/6050/6055/6060/6065/6070/6075/6080/6085/6090/6095/6100/6105/6110/6115/6120/6125/6130/6135/6140/6145/6150/6155/6160/6165/6170/6175/6180/6185/6190/6195/6200/6205/6210/6215/6220/6225/6230/6235/6240/6245/6250/6255/6260/6265/6270/6275/6280/6285/6290/6295/6300/6305/6310/6315/6320/6325/6330/6335/6340/6345/6350/6355/6360/6365/6370/6375/6380/6385/6390/6395/6400/6405/6410/6415/6420/6425/6430/6435/6440/6445/6450/6455/6460/6465/6470/6475/6480/6485/6490/6495/6500/6505/6510/6515/6520/6525/6530/6535/6540/6545/6550/6555/6560/6565/6570/6575/6580/6585/6590/6595/6600/6605/6610/6615/6620/6625/6630/6635/6640/6645/6650/6655/6660/6665/6670/6675/6680/6685/6690/6695/6700/6705/6710/6715/6720/6725/6730/6735/6740/6745/6750/6755/6760/6765/6770/6775/6780/6785/6790/6795/6800/6805/6810/6815/6820/6825/6830/6835/6840/6845/6850/6855/6860/6865/6870/6875/6880/6885/6890/6895/6900/6905/6910/6915/6920/6925/6930/6935/6940/6945/6950/6955/6960/6965/6970/6975/6980/6985/6990/6995/7000/7005/7010/7015/7020/7025/7030/7035/7040/7045/7050/7055/7060/7065/7070/7075/7080/7085/7090/7095/7100/7105/7110/7115/7120/7125/7130/7135/7140/7145/7150/7155/7160/7165/7170/7175/7180/7185/7190/7195/7200/7205/7210/7215/7220/7225/7230/7235/7240/7245/7250/7255/7260/7265/7270/7275/7280/7285/7290/7295/7300/7305/7310/7315/7320/7325/7330/7335/7340/7345/7350/7355/7360/7365/7370/7375/7380/7385/7390/7395/7400/7405/7410/7415/7420/7425/7430/7435/7440/7445/7450/7455/7460/7465/7470/7475/7480/7485/7490/7495/7500/7505/7510/7515/7520/7525/7530/7535/7540/7545/7550/7555/7560/7565/7570/7575/7580/7585/7590/7595/7600/7605/7610/7615/7620/7625/7630/7635/7640/7645/7650/7655/7660/7665/7670/7675/7680/7685/7690/7695/7700/7705/7710/7715/7720/7725/7730/7735/7740/7745/7750/7755/7760/7765/7770/7775/7780/7785/7790/7795/7800/7805/7810/7815/7820/7825/7830/7835/7840/7845/7850/7855/7860/7865/7870/7875/7880/7885/7890/7895/7900/7905/7910/7915/7920/7925/7930/7935/7940/7945/7950/7955/7960/7965/7970/7975/7980/7985/7990/7995/8000/8005/8010/8015/8020/8025/8030/8035/8040/8045/8050/8055/8060/8065/8070/8075/8080/8085/8090/8095/8100/8105/8110/8115/8120/8125/8130/8135/8140/8145/8150/8155/8160/8165/8170/8175/8180/8185/8190/8195/8200/8205/8210/8215/8220/8225/8230/8235/8240/8245/8250/8255/8260/8265/8270/8275/8280/8285/8290/8295/8300/8305/8310/8315/8320/8325/8330/8335/8340/8345/8350/8355/8360/8365/8370/8375/8380/8385/8390/8395/8400/8405/8410/8415/8420/8425/8430/8435/8440/8445/8450/8455/8460/8465/8470/8475/8480/8485/8490/8495/8500/8505/8510/8515/8520/8525/8530/8535/8540/8545/8550/8555/8560/8565/8570/8575/8580/8585/8590/8595/8600/8605/8610/8615/8620/8625/8630/8635/8640/8645/8650/8655/8660/8665/8670/8675/8680/8685/8690/8695/8700/8705/8710/8715/8720/8725/8730/8735/8740/8745/8750/8755/8760/8765/8770/8775/8780/8785/8790/8795/8800/8805/8810/8815/8820/8825/8830/8835/8840/8845/8850/8855/8860/8865/8870/8875/8880/8885/8890/8895/8900/8905/8910/8915/8920/8925/8930/8935/8940/8945/8950/8955/8960/8965/8970/8975/8980/8985/8990/8995/9000/9005/9010/9015/9020/9025/9030/9035/9040/9045/9050/9055/9060/9065/9070/9075/9080/9085/9090/9095/9100/9105/9110/9115/9120/9125/9130/9135/9140/9145/9150/9155/9160/9165/9170/9175/9180/9185/9190/9195/9200/9205/9210/9215/9220/9225/9230/9235/9240/9245/9250/9255/9260/9265/9270/9275/9280/9285/9290/9295/9300/9305/9310/9315/9320/9325/9330/9335/9340/9345/9350/9355/9360/9365/9370/9375/9380/9385/9390/9395/9400/9405/9410/9415/9420/9425/9430/9435/9440/9445/9450/9455/9460/9465/9470/9475/9480/9485/9490/9495/9500/9505/9510/9515/9520/9525/9530/9535/9540/9545/9550/9555/9560/9565/9570/9575/9580/9585/9590/9595/9600/9605/9610/9615/9620/9625/9630/9635/9640/9645/9650/9655/9660/9665/9670/9675/9680/9685/9690/9695/9700/9705/9710/9715/9720/9725/9730/9735/9740/9745/9750/97



Li-ion Ah 6.0 | 5.0 | 4.0 | 3.0 | 2.0 | 1.5

Cordless Power Cutter

Mesin Pemotong Tanpa Kord 充电式切断机



Battery cover
protects battery from water in wet cutting
Penutup pelindung bateri melindungi bateri dari air semasa pemotongan basah
电池保护盖防止电池在潮湿切割时受到水的侵蚀

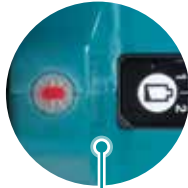

Overload warning LED lamp
• alerts operator of overload with a red blinking LED
• reduces unnecessary battery recharging by overload protection

Lampu amaran LED merah berkedip mengingatkan operator mengenai kelebihan beban, mengurangkan pengecasan bateri yang tidak perlu untuk melindungi bateri dengan berkesan dan memanjangkan hayat bateri
过载LED警告灯, 红色闪烁LED提醒操作过载, 减少不必要的电池充电, 有效保护电池, 延长电池使用寿命

*Jumlah Kerja 工作量
Work Amount
with BL1860B x2
Concrete Cutting 30mm depth
7.8m
length with Diamond Wheel
(approx.)

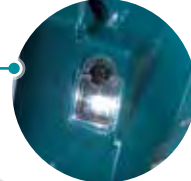

LED job light
enables operation in the dark sites where electricity is not supplied
Lampu kerja LED membolehkan operasi di kawasan gelap
LED工作灯, 昏暗场所中也方便操作

Maximum Cutting Depth
Kedalaman Pemotongan Maksimum
最大切割深度
88 mm

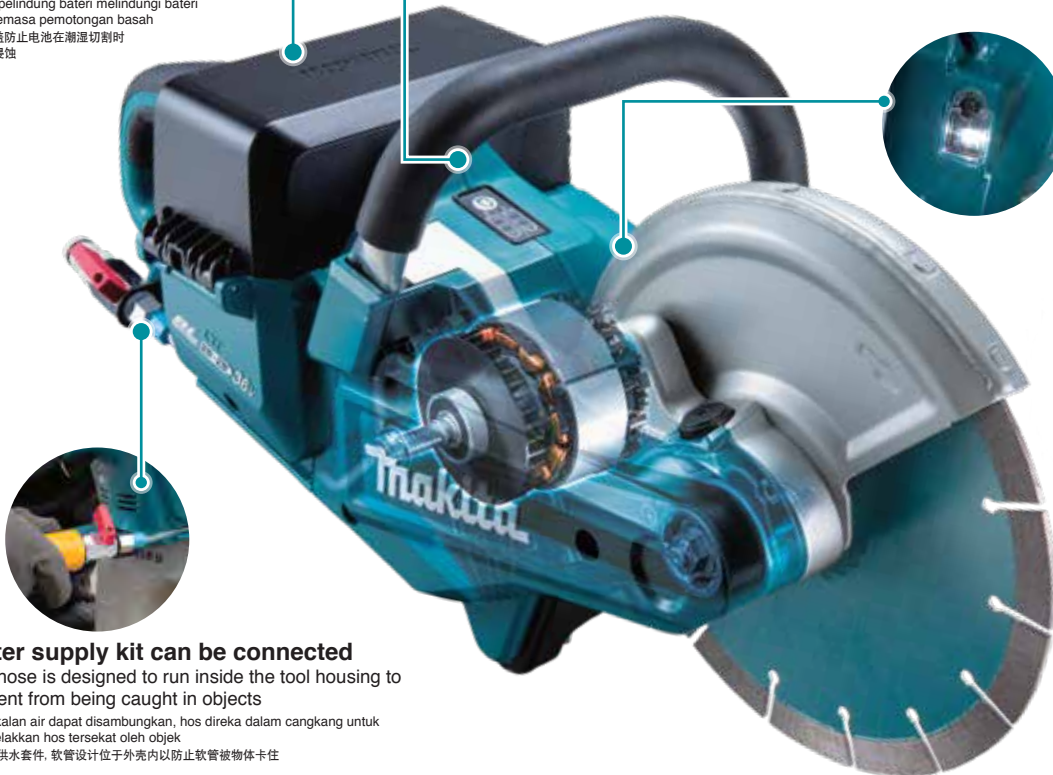

Water supply kit can be connected
The hose is designed to run inside the tool housing to prevent from being caught in objects
Kit bekalan air dapat disambungkan, hos direka dalam cangkang untuk mengelakkan hos tersekat oleh objek
可连接供水套件, 软管设计位于外壳内以防止软管被物体卡住



DCE090Z 230mm (9")
RIM 4,903

Cordless Power Cutter
Mesin Pemotong Tanpa Kord
充电式切断机

• Battery cover protects battery from water in wet cutting

Standard Equipment: Hex Wrench, Wrench, Coupling Sleeve

• Z: Without Charger & Battery



Wheel Diameter Diameter Bilah 锯片直径	230mm (9")
Wheel Hole Diameter Diameter Lubang 孔直径	22.23mm (7/8")
Max Wheel Thickness Ketebalan Roda Maksimum 最大轮片厚度	3.0mm (1/8")
Max Cutting Capacity Kapasiti Pemotongan Maksimum 最大切割能力	88mm (3-1/2")
No Load Speed (RPM) Kelajuan Tanpa Beban 回转数	6,600
Dimensions (L x W x H) Dimensi 体积	554x241x283mm (21-3/4x9-1/2x11-1/8")
Net Weight Berat Bersih 净重	5.6 - 6.3kg (12.3 - 13.9lbs.)
Work Amount (approx.) Jumlah Kerja 工作量	Concrete Cutting 30mm depth 7.8m length with Diamond Wheel with BL1860B x2

* All list price shown are for reference only (exclude SST).

* Semua harga yang ditunjukkan adalah untuk rujukan sahaja (tidak termasuk SST). 所有显示的建议零售价仅供参考 (不包括SST)。

- Cordless Impact Driver 充电式冲击起子机
- LED Flashlight 手电筒 内置LED 18650 18650
- Vacuum Cleaner 吸尘器 内置
- Drilling / Fastening 钻孔 / 紧固 M10 / 3/8"
- Impact Drilling / Demolition 冲击钻孔 / 拆除 M10 / 3/8"
- Cutting 切割 1/2"
- Grinding / Sanding 研磨 / 打磨 1/2"
- Sawing 锯切 1/2"
- Planing / Routing 刨花 / 铣削 1/2"
- Others 其他
- Outdoor Power Equipment 户外动力设备





Li-ion Ah 6.0 | 5.0 | 4.0 | 3.0 | 2.0 | 1.5

Battery Powered Grass Trimmer

Pemotong Rumput Berkuasa Bateri 充电式割草机

"Simple" Portable Power Supply Unit powered by multiple LXT batteries

Unit Bekalan Kuasa Mudah Alih yang dikuasakan oleh pelbagai bateri LXT
由多个LXT电池供电的“简单”便携式电源设备



UR201CZ RM 3,282

Battery Powered Grass Trimmer
Pemotong Rumput Berkuasa Bateri
充电式割草机

- 1.0kW max output power similar to 30mL class engine grass trimmers

Standard Equipment: Safety Goggles (195246-2), Metal Blade, Nylon Cutting Head, Plastic Blade, Blade Cover (for Metal Blade), Accessory Bag, Hex Wrench, Box Wrench, Band Assembly

• CZ: Without Charger & Battery



DUR369LZ RM 3,282

Cordless Grass Trimmer
Pemotong Rumput Tanpa Kord
充电式割草机

- 1.0kW max output power similar to 30mL class engine grass trimmers

Standard Equipment: Safety Goggles (195246-2), Metal Blade, Nylon Cutting Head, Plastic Blade, Blade cover (for metal blade), Accessory Bag, Hex Wrench, Box Wrench, Band Assembly

• LZ: Without Charger & Battery



DUR364LPM4 RM 4,118

DUR364LRM2 RM 3,015

DUR364LZ RM 1,877

Cordless Grass Trimmer
Pemotong Rumput Tanpa Kord
充电式割草机



- 2-Speed options allows the operator to match speed to application

Standard Equipment: Safety Goggles (195246-2), Nylon Cutting Head, Accessory Bag, Hex Wrench

- LPM4: 1x Two Port Multi Fast Charger, 4x 4.0Ah Battery
- LRM2: 1x Rapid Charger, 2x 4.0Ah Battery
- LZ: Without Charger & Battery



Portable Power Pack	Adapter set
PDC1200 Equipped with built-in battery cells  IPX4 Water Resistance	PDC1200A01 included - 18V Adapter (191J51-5) - DC4001 Battery Charger Set (191L01-2) - Harness Assembly (127668-8)  Optional 40Vmax Adapter Set (191N62-4)
Capacity Kapasiti 能力 33.5Ah	
Energy Capacity Keupayaan Tenaga 能量容量 1,206Wh	
Power Supply Cord Kord Bekalan Kuasa 能源线 Battery Side: 1.1m (3.6ft) Adapter Side: 0.6m (2.0ft)	

Portable Power Pack	Adapter set
PDC01 Powered by up to four 18V LXT batteries  IPX4 Water Resistance *Without battery	1 PDC01 (191A62-6) included - 18V Adapter (191J50-7) - 18Vx2 Adapter (191J51-5) - Harness Assembly  2 PDC01 (191A67-6) included - 18Vx2 Adapter (191J51-5) - Harness Assembly  Optional 40Vmax Adapter Set (191N62-4)
Capacity Kapasiti 能力 18V x2 : 12 Ah (with BL1860B x4) 18V : 24 Ah (with BL1860B x4)	
Energy Capacity Keupayaan Tenaga 能量容量 432Wh (BL1860Bx4)	
Power Supply Cord Kord Bekalan Kuasa 能源线 1.7m (5.6 ft)	

Cutting Width Lebar Keratan 切割宽度	Metal Blade: 255mm (10") Nylon Cutting Head: 430mm (17") Plastic Blade: 255mm (10")
No Load Speed (RPM) Kelajuan Tanpa Beban 回转数	Metal Blade (3 / 2 / 1): 0 - 7,000 / 0 - 5,500 / 0 - 4,600 Nylon Cutting Head (3 / 2 / 1): 0 - 5,500 / 0 - 5,000 / 0 - 4,600 Plastic Blade (305mm) (3 / 2 / 1): 0 - 7,000 / 0 - 5,500 / 0 - 4,600 Plastic Blade (255mm) (3 / 2 / 1): 0 - 5,500 / 0 - 5,000 / 0 - 4,600
Spindle Size Saiz Spindel 主轴尺寸	M10 x 1.25LH
Dimensions (L x W x H) Dimensi 体积	1,795x400x269mm (70-1/2"x15-3/4"x10-5/8")
Net Weight Berat Bersih 净重	4.7kg (10.4lbs.)
Continuous Usage Time (approx.) Masa Penggunaan Berterusan 连续使用时间	Low: 76 min with PDC01 (BL1860B x4) Metal blade with load

Cutting Width Lebar Keratan 切割宽度	Metal Blade: 255mm (10") Nylon Cutting Head: 430mm (17") Plastic Blade: 305mm (12")
No Load Speed (RPM) Kelajuan Tanpa Beban 回转数	Metal Blade (3 / 2 / 1): 0 - 7,000 / 0 - 5,500 / 0 - 4,600 Nylon Cutting Head (3 / 2 / 1): 0 - 5,500 / 0 - 5,000 / 0 - 4,600 Plastic Blade (305mm) (3 / 2 / 1): 0 - 7,000 / 0 - 5,500 / 0 - 4,600 Plastic Blade (255mm) (3 / 2 / 1): 0 - 5,500 / 0 - 5,000 / 0 - 4,600
Spindle Size Saiz Spindel 主轴尺寸	M10 x 1.25LH
Dimensions (L x W x H) Dimensi 体积	1,846x400x269mm (72-1/2"x15-3/4"x10-5/8")
Net Weight Berat Bersih 净重	5.7 - 6.3kg (12.6 - 13.9lbs.)
Continuous Usage Time (approx.) Masa Penggunaan Berterusan 连续使用时间	Low: 38 min with BL1860B x2 Metal blade with load

Cutting Width Lebar Keratan 切割宽度	Trimmer Head: 350mm (13-3/4") Plastic Blade: 255mm (10")
No Load Speed (RPM) Kelajuan Tanpa Beban 回转数	High: 6,500 Low: 5,000
Spindle Size Saiz Spindel 主轴尺寸	M8 x 1.25RH
Dimensions (L x W x H) Dimensi 体积	1,754x310x229mm (69"x12-1/4"x9")
Net Weight Keberatan 净重	3.6 - 4.4kg (8.0 - 9.7lbs)
Continuous Usage Time (approx.) Masa Penggunaan Berterusan 连续使用时间	Low: 60 min High: 34 min with BL1850B x2 Nylon cutting head with load

* All list price shown are for reference only (exclude SST).

* Semua harga yang ditunjukkan adalah untuk rujukan sahaja (tidak termasuk SST). 所有显示的建议零售价仅供参考 (不包括SST)。

Cordless
LED Flashlight
Vacuum Cleaner
Drilling / Finishing
Impact Drilling / Demolition
Cutting / Trimming
Grinding / Smoothing
Sawing
Planing / Routing
Others
Outdoor Power Equipment





Li-ion Ah 6.0 5.0 4.0 3.0 2.0 1.5

DUR368APT2 | DUR368AZ
RM 4,513 | RM 2,927

Cordless Grass Trimmer
Pemotong Rumput Tanpa Kord
充电式割草机



- Lightweight for reduced operator fatigue

Standard Equipment: Safety Goggles (195246-2), Plastic Blade, Accessory Bag, Hex Wrench, Band Assembly

- APT2: 1x Two Port Multi Fast Charger, 2x 5.0Ah Battery
- AZ: Without Charger & Battery



Cutting Width Lebar Keratan 切割宽度	Metal Blade: 255mm (10") Trimmer Head: 350mm (13-3/4") Plastic Blade: 255mm (10")
No Load Speed (RPM) Kelajuan Tanpa Beban 回转速数	High: 6,500 Med: 5,300 Low: 3,500
Spindle Size Saiz Spindel 主轴尺寸	M10 x 1.25LH
Dimensions (L x W x H) Dimensi 体积	1,758x615x442mm (69-1/4"x24-1/4"x17-3/8")
Net Weight Berat Bersih 净重	4.1 - 4.7kg (9.0 - 10.5lbs.)
Continuous Usage Time (approx.) Masa Penggunaan Berterusan 连续使用时间	Low: 106 min with BL1860B x2 Plastic blade with load

DUR368LPT2 | DUR368LZ
RM 4,190 | RM 2,605

Cordless Grass Trimmer
Pemotong Rumput Tanpa Kord
充电式割草机

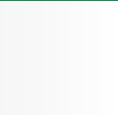

- Lightweight for reduced operator fatigue

Standard Equipment: Safety Goggles (195246-2), Plastic Blade (198384-9), Accessory Bag, Hex Wrench, Band Assembly

- LPT2: 1x Two Port Multi Fast Charger, 2x 5.0Ah Battery
- LZ: Without Charger & Battery



Cutting Width Lebar Keratan 切割宽度	Metal Blade: 230mm (9") Trimmer Head: 350mm (13-3/4") Plastic Blade: 255mm (10")
No Load Speed (RPM) Kelajuan Tanpa Beban 回转速数	High: 6,500 Med: 5,300 Low: 3,500
Spindle Size Saiz Spindel 主轴尺寸	M10 x 1.25LH
Dimensions (L x W x H) Dimensi 体积	1,758x362x231mm (69-1/4"x14-1/4"x9-1/8")
Net Weight Berat Bersih 净重	3.9 - 4.5kg (8.6 - 10.0lbs.)
Continuous Usage Time (approx.) Masa Penggunaan Berterusan 连续使用时间	Low: 106 min with BL1860B x2 Plastic blade with load

DUP362ZN
RM 7,523

Battery Powered Pruning Shears
Gunting Pemangkas Bateri
充电式电剪



- Extra sharp, Made-in-Japan forged blade

Standard Equipment: Oil Supply, Wrench Set, Diamond File, Cord Holder, Holster, Harness, Arm Band, Tool Bag, Shear Blade

- ZN: Without Charger & Battery



Max Output Keluaran Maksima 最大输出	200W
Capacity Kapasiti 能力	Max Cutting : 33mm (1-5/16") Max Blade Opening: 54mm
Cutting Torque Tork Pemotongan 切割扭矩	250N
Dimensions (L x W x H) Dimensi 体积	305x43x106mm (12"x1-11/16"x4-3/16")
Net Weight Keberatan 净重	0.77 - 0.82kg (1.7 - 1.8lbs.)
Work Amount (approx.) Jumlah Kerja 工作量	71,000cuts with BL1850B x2 (ø15mm Grape Wine Branch)

DUP361Z
RM 6,630

Battery Powered Pruning Shears
Gunting Pemangkas Bateri
充电式电剪

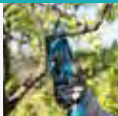

- Extra sharp, Made-in-Japan forged blade

Standard Equipment: Oil Supply, Wrench Set, Diamond File, Cord Holder, Holster, Harness, Arm Band, Tool Bag, Shear Blade

- Z: Without Charger & Battery



Max Output Keluaran Maksima 最大输出	200W
Capacity Kapasiti 能力	Max Cutting : 33mm Max Blade Opening: 54mm
Cutting Torque Tork Pemotongan 切割扭矩	185N
Dimensions (L x W x H) Dimensi 体积	305x43x106mm (12"x1-11/16"x4-3/16")
Net Weight Keberatan 净重	0.8kg (1.8lbs)
Work Amount (approx.) Jumlah Kerja 工作量	71,000cuts with BL1850B x2 (ø15mm Grape Wine Branch)



* All list price shown are for reference only (exclude SST).

* Semua harga yang ditunjukkan adalah untuk rujukan sahaja (tidak termasuk SST). 所有显示的建议零售价仅供参考 (不包括SST)。

Cordless Target Kordless
LED Flashlight Lampu Cahaya LED
Vacuum Cleaner Penyedut Vakuum
Drilling / Fastening
Impact Drilling / Demolition
Cutting
Grinding / Sanding
Sawing
Planing / Routing
Others
Outdoor Power Equipment





Li-ion Ah 6.0 5.0 4.0 3.0 2.0 1.5

Cordless Lawn Mower

Mesin Pemotong Rumput Tanpa Kord 充电式手推割草机



PDC1200
Powered by 36V-40Vmax built-in battery



PDC01
Powered by up to four 18V LXT batteries

LM001CZ

Price TBA

Battery Powered Lawn Mower

Mesin Pemotong Rumput Tanpa Kord
充电式手推割草机

- Long continuous operation

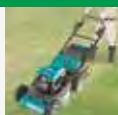

Standard Equipment: Blade, Mulch Plug, Side Discharge Mouth, Box Wrench, Rod

• CZ: Without Charger & Battery



Blade Hole Diameter Diameter lubang bilah 叶片孔直径	10.0mm (3/8")
Cutting Width Lebar Keratan 切割宽度	534mm (21")
Cutting Height Ketinggian Pemotongan 切割高度	20 - 100mm (13/16" - 3-15/16")
Grass box capacity Kapasiti Kotak Rumput 草箱容量	60L
No Load Speed (RPM) Kelajuan Tanpa Beban 回转数	2,300 - 2,800
Wheel Size Saiz Roda 轮片尺寸	Front / Rear: 230mm (9")
Dimensions (L x W x H) Dimensi 体积	1,630-1,715x590x990-1,095mm (64"-67-1/2"x23-1/4"x39"-43")
Net Weight Berat Bersih 净重	39.0 - 42.8kg (86.0 - 94.4lbs.)
Continuous Usage Time (approx.) Masa Penggunaan Berterusan 连续使用时间	33min (self-propelled) 45min (push-drive) with PDC01, BL1850B x2

DLM533Z 530mm (21")

RM 7,292

Cordless Lawn Mower

Mesin Pemotong Rumput Tanpa Kord
充电式手推割草机

- Aluminum die-cast deck does not rust even if scratched or damaged



Standard Equipment: Blade, Mulch Plug, Socket Wrench, Rod

• Z: Without Charger & Battery



Cutting Width Lebar Keratan 切割宽度	534mm (21")
Cutting Height Ketinggian Pemotongan 切割高度	20 - 100mm (13/16" - 3-15/16")
Grass Box Capacity Kapasiti Kotak Rumput 草箱容量	70L
No Load Speed (RPM) Kelajuan Tanpa Beban 回转数	Standard Mode: 2,300 / 2,800 Low Noise Mode: 2,300
Propelling Speed Kelajuan Mendorong 推进速度	2.5 - 5.0 km/h
Wheel Size Saiz Roda 轮片尺寸	Front: 230mm (9") Rear: 230mm (9")
Dimensions (L x W x H) Dimensi 体积	1,655-1,740x590x990-1,100mm (65-68-1/2"x23-1/4"x39-43-1/4")
Net Weight Berat Bersih 净重	42.8 - 46.7kg (94.4 - 103lbs.)
Continuous Usage Time (approx.) Masa Penggunaan Berterusan 连续使用时间	40 min (Self-Propelled) with BL1860B x2

DLM532Z 534mm (21")

RM 6,563

Cordless Lawn Mower

Mesin Pemotong Rumput Tanpa Kord
充电式手推割草机

- IPX4 water resistant for use in bad weather



Standard Equipment: Blade, Mulch plug, Side Discharge Mouth, Socket Wrench, Rod

• Z: Without Charger & Battery



Blade Hole Diameter Diameter lubang bilah 叶片孔直径	10.0mm (3/8")
Cutting Width Lebar Keratan 切割宽度	534mm (21")
Cutting Height Ketinggian Pemotongan 切割高度	20 - 100mm (13/16" - 3-15/16")
Grass box capacity Kapasiti Kotak Rumput 草箱容量	70L
No Load Speed (RPM) Kelajuan Tanpa Beban 回转数	2,300 - 2,800
Wheel Size Saiz Roda 轮片尺寸	Front / Rear: 230mm (9")
Dimensions (L x W x H) Dimensi 体积	1,630-1,715x590x990-1,095mm (64"-67-1/2"x23-1/4"x39"-43")
Net Weight Berat Bersih 净重	39.0 - 42.8kg (86.0 - 94.4lbs.)
Continuous Usage Time (approx.) Masa Penggunaan Berterusan 连续使用时间	40 min (self-propelled) 54 min (push-drive) with BL1860B x2

DLM460Z 460mm (18")

RM 3,743

Cordless Lawn Mower

Mesin Pemotong Rumput Tanpa Kord
充电式手推割草机

- IPX4 water resistant for use in bad weather



Standard Equipment: Blade, Socket Wrench

• Z: Without Charger & Battery



Blade Type Jenis Bilah 刀片类型	2 Tooth
Cutting Width Lebar Keratan 切割宽度	460mm (18")
Cutting Height Ketinggian Pemotongan 切割高度	20 - 75mm (13/16" - 2-15/16")
Grass Box Capacity Kapasiti Kotak Rumput 草箱容量	60L
No Load Speed (RPM) Kelajuan Tanpa Beban 回转数	2,500 - 3,300
Recommended Mowing Area Julat Memotong Yang Disyorkan 推荐的割草范围	With BL1850B x2: 680 - 1,360m ²
Wheel Size Saiz Roda 轮片尺寸	Front: 180mm (7") Rear: 205mm (8")
Max Output Keluaran Maksima 最大输出	1,450W
Dimensions (L x W x H) Dimensi 体积	1,319-1,518 x 532 x 879-1,138mm (52"-59-3/4" x 21" x 34-1/2"-44-3/4")
Net Weight Berat Bersih 净重	25.3 - 27.6kg (55.8 - 60.8lbs.)
Continuous Usage Time (approx.) Masa Penggunaan Berterusan 连续使用时间	18 min with BL1850B x2

* All list price shown are for reference only (exclude SST).

* Semua harga yang ditunjukkan adalah untuk rujukan sahaja (tidak termasuk SST). 所有显示的建议零售价仅供参考 (不包括SST)。

Cordless
Tempat
Tempat
Tempat

LED Flashlight
Tempat
Tempat
Tempat

Vacuum Cleaner
Tempat
Tempat
Tempat

Drilling / Fastening
Tempat
Tempat
Tempat

Impact Drilling / Demolition
Tempat
Tempat
Tempat

Cutting
Tempat
Tempat
Tempat

Grinding / Sanding
Tempat
Tempat
Tempat

Sawing
Tempat
Tempat
Tempat

Planing / Routing
Tempat
Tempat
Tempat

Others
Tempat
Tempat
Tempat

Outdoor Power Equipment
Tempat
Tempat
Tempat

Makita
Tempat
Tempat
Tempat



Li-ion Ah 6.0 5.0 4.0 3.0 2.0 1.5

DLM432PT2 | **DLM432Z** 430mm (17")
 RM 4,047 | RM 2,460

Cordless Lawn Mower
 Mesin Pemotong Rumput
 Tanpa Kord
 充电式手推割草机

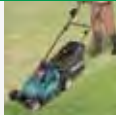

- Low noise level suitable for use in residential areas and public spaces

Standard Equipment: Blade, Mulch Plug, Socket Wrench

- PT2: 1x Two Port Multi Fast Charger, 2x 5.0Ah Battery
- Z: Without Charger & Battery



Cutting Width Lebar Keratan 切割宽度	430mm (17")
Cutting Height Ketinggian Pemotongan 切割高度	20 - 75mm (13/16" - 2-15/16")
Grass Box Capacity Kapasiti Kotak Rumput 草箱容量	50L
No Load Speed (RPM) Kelajuan Tanpa Beban 回转数	3,600
Wheel Size Saiz Roda 轮片尺寸	Front: 140mm (5-1/2") Rear: 160mm (6-5/16")
Dimensions (L x W x H) Dimensi 体积	1,435-1,490x460x1,005-1,045mm (56-1/2"-58-3/4"x18-1/8"x39-1/2"-41-1/4")
Net Weight Berat Bersih 净重	16.8 - 17.5kg (37.0 - 38.6lbs.)
Continuous Usage Time (approx.) Masa Penggunaan Berterusan 连续使用时间	30 min with BL1850B x2

DLM431PT2 | **DLM431Z** 430mm (17")
 RM 4,457 | RM 2,872

Cordless Lawn Mower
 Mesin Pemotong Rumput
 Tanpa Kord
 充电式手推割草机



- Large 50L capacity grass basket reduces the need for emptying

Standard Equipment: Blade, Socket Wrench

- PT2: 1x Two Port Multi Fast Charger, 2x 5.0Ah Battery
- Z: Without Charger & Battery



Blade Type Jenis Bilah 刀片类型	2 Tooth, Rotary Type
Cutting Width Lebar Keratan 切割宽度	430mm (17")
Cutting Height Ketinggian Pemotongan 切割高度	20 - 75mm (13/16" - 2-15/16")
Grass Box Capacity Kapasiti Kotak Rumput 草箱容量	50L
No Load Speed (RPM) Kelajuan Tanpa Beban 回转数	3,600
Recommended Mowing Area Julat Memotong Yang Disyorkan 推荐的割草范围	With BL1850B x2: 475 - 950m ²
Wheel Size Saiz Roda 轮片尺寸	Front: 140mm (5 - 1/2") Rear: 160mm (6 - 5/16")
Dimensions (L x W x H) Dimensi 体积	1,450-1,490x460x950-1,020mm (57-5/8"-58-1/8"x18-1/8"x37-1/2"-40-1/4")
Net Weight Keberatan 净重	17.8 - 18.4kg (39.2 - 40.6lbs)
Continuous Usage Time (approx.) Masa Penggunaan Berterusan 连续使用时间	30 min with BL1850B x2

DLM382PT2 | **DLM382CM2** | **DLM382Z** 380mm (15")
 RM 3,408 | **NEW** RM 3,248 | RM 1,823

Cordless Lawn Mower
 Mesin Pemotong Rumput
 Tanpa Kord
 充电式手推割草机

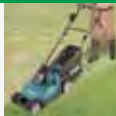

- Zero emissions and reduced maintenance; no need for gas or oil

Standard Equipment: Blade, Mulch Plug, Socket Wrench

- PT2: 1x Two Port Multi Fast Charger, 2x 5.0Ah Battery
- CM2: 1x Two Port Multi Charger (DC18SH), 2x 4.0Ah Battery
- Z: Without Charger & Battery



Cutting Width Lebar Keratan 切割宽度	380mm (15")
Cutting Height Ketinggian Pemotongan 切割高度	20 - 75mm (13/16" - 2-15/16")
Grass Box Capacity Kapasiti Kotak Rumput 草箱容量	40L
No Load Speed (RPM) Kelajuan Tanpa Beban 回转数	3,700
Wheel Size Saiz Roda 轮片尺寸	Front: 140mm (5-1/2") Rear: 160mm (6-5/16")
Dimensions (L x W x H) Dimensi 体积	1,380-1,410x450x985-1,005mm (54-1/4"-55-1/2"x17-3/4"x38-3/4"-39-1/2")
Net Weight Berat Bersih 净重	16.2 - 16.9 kg (35.7 - 37.3 lbs.)
Continuous Usage Time (approx.) Masa Penggunaan Berterusan 连续使用时间	36 min with BL1860B x2

DLM380Z 380mm (15")
 RM 2,290

Cordless Lawn Mower
 Mesin Pemotong Rumput
 Tanpa Kord
 充电式手推割草机



- Zero emissions and reduced maintenance

Standard Equipment: Blade, Wrench

- Z: Without Charger & Battery



Blade Type Jenis Bilah 刀片类型	2 Tooth, Rotary Type
Cutting Width Lebar Keratan 切割宽度	380mm (15")
Cutting Height Ketinggian Pemotongan 切割高度	25 - 75mm (1" - 2-15/16")
Grass Box Capacity Kapasiti Kotak Rumput 草箱容量	40L
No Load Speed (RPM) Kelajuan Tanpa Beban 回转数	3,700
Recommended Mowing Area Julat Memotong Yang Disyorkan 推荐的割草范围	With BL1830B x2: 270 - 540m ²
Wheel Size Saiz Roda 轮片尺寸	Front: 140mm (5 - 1/2") Rear: 190mm (7 - 1/2")
Dimensions (L x W x H) Dimensi 体积	1,145x465x1,023-1,070mm (45"x18-1/4"x40-1/4"-42")
Net Weight Keberatan 净重	14.5kg (32.0lbs)
Continuous Usage Time (approx.) Masa Penggunaan Berterusan 连续使用时间	30 min with BL1850B x2

Model	Deck	Self-Propelled	BL MOTOR	Battery slots	Cutting	Collecting	Mulching	Rear discharge	Side discharge
DLM533	Aluminum	✓	✓	4	✓	✓	✓	✓	
DLM532	Steel	✓	✓	4	✓	✓	✓		✓
DLM460	Steel		✓	2	✓	✓	✓		
DLM432	Plastic			2	✓	✓	✓*		
DLM431	Plastic			2	✓	✓			
DLM382	Plastic			2	✓	✓	✓*		
DLM380	Plastic			2	✓	✓			

* Optional accessory for Mulching (DLM432 / DLM382)

* All list price shown are for reference only (exclude SST).

* Semua harga yang ditunjukkan adalah untuk rujukan sahaja (tidak termasuk SST). 所有显示的建议零售价仅供参考 (不包括SST)。

Cordless Target Kordless
 LED Flashlight Lampu Cahaya LED
 Vacuum Cleaner Pembersih Vakuum
 Drilling / Fastening
 Impact Drilling / Demolition
 Cutting / Pemotongan
 Grinding / Sanding
 Sawing / Gergaji
 Planing / Routing
 Drivers / Bor
 Outdoor Power Equipment
 Makita



Li-ion Ah 6.0 5.0 4.0 3.0 2.0 1.5

Cordless Telescopic Pole Saw

Gergaji Rantai Teleskopik Tanpa Kord
充电式无刷伸缩式高枝链锯

Work Efficiency
Kecekapan Kerja 工作效率
6.2sec
Torque Boost Mode
Ø200 cedar timber

Saw Head Weight
Berat Bersih 净重
0.7kg

Telescopic Pole (DUA301 only)
Tool-less pole extension and fixing for easy adjustment of pole length
Sambungan dan pelekapan batang bebas alat, mudah menyesuaikan panjang rod
免工具杆延长和固定, 便于调节杆长度

Maximum total length **3,762mm**
Shortest total length **2,530mm**
Telescopic
Fixed length
Total length **2,238mm**
Battery guard also can be used as an auxiliary grip

DUA301ZB
RM 3,082

Cordless Telescopic Pole Saw
Gergaji Rantai Teleskopik Tanpa Kord
充电式无刷伸缩式高枝链锯

NEW BARU 新

- The chain speed is the same or higher than competing models, enabling comfortable cutting

Standard Equipment:
Saw Chain, Guide Bar, Guide Bar Case, Wrench, Band Assembly (191K37-5), Hex Wrench, Round File, Safety Goggles (195246-2), Chain Oil

• ZB: Without Charger & Battery

BL MOTOR XPT AFT

Guide Bar Length Panjang Bar Panduan 导板长度	300mm (12")
Max Output Keluaran Maksima 最大输出	Normal Mode: 1,000W Torque Boost Mode: 1,400W
Oil Tank Capacity Tangki Minyak Pelincir 链油箱	160mL
Saw Chain Rantai 链条	Gauge: 1.1 / 1.3mm (0.043 / 0.050") Pitch: 9.5mm (3/8")
Chain Speed Kelajuan Rantai 链条速度	0 - 20.0m/s (0 - 1,200m/min) (0 - 3,940FPM)
Dimensions (L x W x H) Dimensi 体积	2,826-4,058x155x191mm (111-160x6-1/8x7-1/2")
Net Weight Berat Bersih 净重	7.8 - 8.5kg (17.2 - 18.7lbs.)
Work Amount (approx.) Jumlah Kerja 工作量	238 cuts with BL1860B x2 100 x 100 Cedar square timber

DUA300ZB
RM 2,533

Cordless Pole Saw
Gergaji Rantai Teleskopik Tanpa Kord
充电式无刷高枝链锯

NEW BARU 新

- The chain speed is the same or higher than competing models, enabling comfortable cutting

Standard Equipment:
Saw Chain, Guide Bar, Guide Bar Case, Wrench, Band Assembly (191K37-5), Round File, Safety Goggles (195246-2), Chain Oil

• ZB: Without Charger & Battery

BL MOTOR XPT AFT

Guide Bar Length Panjang Bar Panduan 导板长度	300mm (12")
Max Output Keluaran Maksima 最大输出	Normal Mode: 1,000W Torque Boost Mode: 1,400W
Oil Tank Capacity Tangki Minyak Pelincir 链油箱	160mL
Saw Chain Rantai 链条	Gauge: 1.1 / 1.3mm (0.043 / 0.050") Pitch: 9.5mm (3/8")
Chain Speed Kelajuan Rantai 链条速度	0 - 20.0m/s (0 - 1,200m/min) (0 - 3,940FPM)
Dimensions (L x W x H) Dimensi 体积	2,478x155x191mm (97-1/2x6-1/8x7-1/2")
Net Weight Berat Bersih 净重	6.1 - 6.9kg (13.5 - 15.2lbs.)
Work Amount (approx.) Jumlah Kerja 工作量	238 cuts with BL1860B x2 100 x 100 Cedar square timber

DUC406Z 400mm (16")
RM 3,160

Cordless Chain Saw
Gergaji Rantai Tanpa Kord
充电式链锯

- Low noise level and zero emissions for operator comfort

Standard Equipment:
Saw Chain, Guide Bar, Guide Bar Cover, Chain Oil, Socket Wrench

• Z: Without Charger & Battery

BL MOTOR XPT AFT

Guide Bar Length Panjang Bar Panduan 导板长度	400mm (16")
Chain Pitch Kerapatan Rantai 链条齿距	9.5mm (3/8")
Chain Gauge Ketebalan Rantai 链条厚度	1.3mm (0.05")
Chain Speed Kelajuan Rantai 链条速度	0 - 20m/s (0 - 1,200 m/min) (0 - 3,940 FPM)
Chain Oil Tank Volume Tangki Minyak Pelincir 链油箱	200mL (6.8US oz)
Dimensions (L x W x H) Dimensi 体积	270-651x205x232mm (10-5/8"-25-5/8"x8-1/8"x9-1/8")
Net Weight Berat Bersih 净重	5.1kg (11.1lbs.)
Work Amount (approx.) Jumlah Kerja 工作量	500 cuts with BL1850B x2 50 x 50 mm Cedar timber

* All list price shown are for reference only (exclude SST).

* Semua harga yang ditunjukkan adalah untuk rujukan sahaja (tidak termasuk SST). 所有显示的建议零售价仅供参考 (不包括SST)。

Cordless
Tempat Kerja Tanpa Kord

LED Flashlight
Lampu Senter LED
- LED LIGHT

Vacuum Cleaner
Penyedut Debu
- 2.5L

Drilling / Fastening
Gergaji / Pengikat
- 1/2" / 3/8"

Impact Drilling / Demolition
Gergaji / Pecutah
- 1/2" / 3/8"

Cutting / Trimming
Gergaji / Pemotong
- 1/2"

Grinding / Smoothing
Gergaji / Pemutih
- 1/2"

Sawing
Gergaji
- 1/2"

Planing / Routing
Gergaji / Tergamit
- 1/2"

Others
Lain-lain
- 1/2"

Outdoor Power Equipment
Alat Kuasa Luar
- 1/2"

Makita
POWER TOOL



Li-ion Ah 6.0 5.0 4.0 3.0 2.0 1.5

DUC356Z 350mm (14")
RM 2,162

Cordless Chain Saw
Gergaji Rantai Tanpa Kord
充电式链锯



- Low noise level and zero emissions for operator comfort

Standard Equipment: Saw Chain, Guide Bar, Guide Bar Cover, Spike Bumper, Chain Oil, Socket Wrench

- Z: Without Charger & Battery



Guide Bar Length Panjang Bar Panduan 导板长度	350mm (14")
Chain Pitch Kerapatan Rantai 链条齿距	9.5mm (3/8")
Chain Gauge Ketebalan Rantai 链条厚度	1.1(0.043") or 1.3mm (0.050")
Chain Speed Kelajuan Rantai 链条速度	0 - 20m/s (0 - 1,200 m/min) (0 - 3,940 FPM)
Chain Oil Tank Volume Tangki Minyak Pelincir 链油箱	200mL (6.8US oz)
Dimensions (L x W x H) Dimensi 体积	270-651x205x232mm (10-5/8"-25-5/8"x8-1/8"x9-1/8")
Net Weight Berat Bersih 净重	5.1kg (11.1lbs.)
Work Amount (approx.) Jumlah Kerja 工作量	500 cuts with BL1850B x2 50 mm Timber

DUC355Z 350mm (14")
RM 2,048

Cordless Chain Saw
Gergaji Rantai Tanpa Kord
充电式链锯



- Constant speed control maintains constant speed under heavy load

Standard Equipment: Saw Chain, Guide Bar, Guide Bar Cover, Chain Oil, Socket Wrench

- Z: Without Charger & Battery



Guide Bar Length Panjang Bar Panduan 导板长度	350mm (14")
Chain Pitch Kerapatan Rantai 链条齿距	9.5mm (3/8")
Chain Gauge Ketebalan Rantai 链条厚度	1.1mm (0.043")
Chain Speed Kelajuan Rantai 链条速度	0 - 20m/s (0 - 1,200m/min) (0 - 3,940 FPM)
Chain Oil Tank Volume Tangki Minyak Pelincir 链油箱	200mL (6.8US oz)
Dimensions (L x W x H) Dimensi 体积	762x211x235mm (30"x8-5/16"x9-1/4")
Net weight Berat Bersih 净重	4.7 - 5.4kg (10.4 - 11.8lbs.)
Work Amount (approx.) Jumlah Kerja 工作量	550 cuts with BL1850B x2 50 mm Timber

DUC353Z 350mm (14")
RM 2,237

Cordless Chain Saw
Gergaji Rantai Tanpa Kord
充电式链锯



- Cordless Chain Saw DUC353 Efficiency Similar to 30ml Class Engine Chain Saw

Standard Equipment: Saw Chain, Guide Bar, Guide Bar Cover, Chain Oil

- Z: Without Charger & Battery



Guide Bar Length Panjang Bar Panduan 导板长度	350mm (14")
Chain Pitch Kerapatan Rantai 链条齿距	9.5mm (3/8")
Chain Gauge Ketebalan Rantai 链条厚度	1.1 (0.043") or 1.3mm (0.050")
Chain Speed Kelajuan Rantai 链条速度	0 - 20m/s (0 - 1,200m/min) (0 - 3,940FPM)
Chain Oil Tank Volume Tangki Minyak Pelincir 链油箱	200mL (6.8US oz)
Dimensions (L x W x H) Dimensi 体积	773x215x235mm (30-1/2"x8-1/2"x9-1/4")
Net Weight Keberatan 净重	4.7kg (10.4 lbs)
Work Amount (approx.) Jumlah Kerja 工作量	550 cuts with BL1850B x2 50 mm Timber

DUC252PM4 | **DUC252Z** 250mm (10")
RM 4,275 | RM 2,032 442

Cordless Chain Saw
Gergaji Rantai Tanpa Kord
充电式链锯



- Low noise level and zero emissions for operator comfort

Standard Equipment: Saw Chain (196205-9), Guide Bar (168408-5), Guide Bar Cover (455284-9), Spike Bumper

- PM4: 1x Two Port Multi Rapid Charger, 4x 4.0Ah Battery, 1x Tool Bag
- Z: Without Charger & Battery



Guide Bar Length Panjang Bar Panduan 导板长度	250mm (10")
Chain Pitch Kerapatan Rantai 链条齿距	9.5mm (3/8")
Chain Gauge Ketebalan Rantai 链条厚度	1.3mm (0.050")
Chain Speed Kelajuan Rantai 链条速度	8.3m/s (500m/min) (1,650FPM)
Chain Oil Tank Volume Tangki Minyak Pelincir 链油箱	85mL (2.9US oz)
Dimensions (L x W x H) Dimensi 体积	545x234x198mm (21-1/2"x9-1/4"x7-3/4")
Net Weight Keberatan 净重	4.1 - 4.7kg (9.0 - 10.3lbs)
Work Amount (approx.) Jumlah Kerja 工作量	560 cuts with BL1850B x2 50 mm Timber

Model	Standard Equipment			Optional Accessories							
	Guide Bar		Saw Chain	Bar Cover	Guide Bar		Saw Chain	Bar Cover	Drive Sprocket		
DUA301/ DUA300	30cm/ 12" sprocket nose bar	165200-0	12"/ 1.3mm/ 0.050" 3/8" 46Links	196206-7	419288-5	30cm/ 12" sprocket nose bar	191G23-2	12"/ 1.3mm/ 0.050" 3/8" 46Links	196206-7	419288-5	226992-7
DUC406	40cm/ 16" Sprocket nose bar	165247-4	16"/ 1.1mm/ 0.043" 3/8" 56Links	196742-3	419242-9	40cm/ 16" Sprocket nose bar	191G17-7	16"/ 1.1mm/ 0.043" 3/8" 56Links	196742-3	419242-9	199063-2
DUC356/ DUC355/ DUC353	35cm/ 14" Sprocket nose bar	165246-6	14"/ 1.1mm/ 0.043" 3/8" 46Links	196741-5	419288-5	35cm/ 14" Sprocket nose bar	191G16-9	14"/ 1.1mm/ 0.043" 3/8" 46Links	196741-5	419288-5	199063-2
DUC254	25cm/ 10" sprocket nose bar	161846-0	10"/ 1.1mm/ 0.043" 3/8" 40Links	199075-5	458501-6	25cm/ 10" sprocket nose bar	191G14-3	10"/ 1.1mm/ 0.043" 3/8" 40Links	199075-5	458501-6	199063-2

* All list price shown are for reference only (exclude SST).

* Semua harga yang ditunjukkan adalah untuk rujukan sahaja (tidak termasuk SST). 所有显示的建议零售价仅供参考 (不包括SST)。

Cordless Target Kuching
 LED Flashlight Lampu Cahaya LED
 Vacuum Cleaner Penyedut Vakuum
 Drilling / Fastening
 Impact Drilling / Demolition
 Cutting / Penapis
 Grinding / Sanding
 Sawing / Sawing
 Planing / Routing
 Drivers / Drivers
 Outdoor Power Equipment





Li-ion Ah 6.0 5.0 4.0 3.0 2.0 1.5

Cordless Multi Function Power Head

Powerhead Pelbagai Fungsi Tanpa Kord
充电式多功动力机

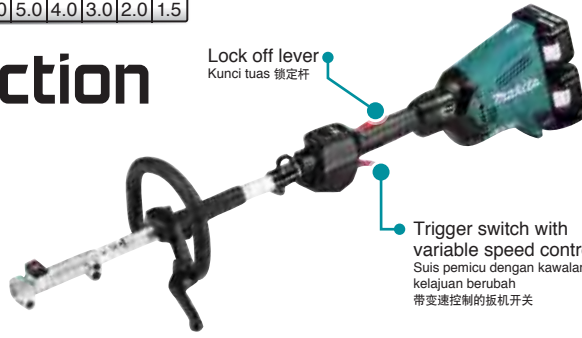

Max Output
Keluaran maksimum
最大输出
0.6kW



<p>Brushcutter Mesin potong rumput 割草器 EM400MP Part No. 195657-1 EM403MP Part No. 198760-7 <i>*LUX01G / DUX60 only</i></p>	<p>Power brush Pembersih berus 毛刷清扫器 BR400MP Part No. 199323-2</p>	<p>Power sweep Penyapu lantai 地面扫除器 SW400MP Part No. 199344-4</p>	<p>Coffee harvester Penuai Kopi 咖啡豆采收器 EJ400MP Part No. 197163-2</p>	<p>Pole saw Batang gergaji 高枝链锯 EY401MP Part No. 199925-4 EY403MP Part No. 191T41-8</p>	<p>Edger Kemasan tepi 草坪修边机具 EE400MP Part No. 196752-0</p>
<p>Grass Trimmer Mesin potong rumput 割草器 EM408MP Part No. 191N34-9 EM409MP Part No. 191N46-2</p>	<p>Ground trimmer Pemangkas tanaman 地面修剪器 EN420MP (Angle adjustable) Part No. 198061-3</p>	<p>Hedge trimmer Pemangkas tanaman 篱笆修剪器 EN410MP (Straight) Part No. 197742-6</p>	<p>Shaft extension attachment Penyambung alat 延伸杆 LE400MP Part No. 191E23-0 Length: 1,080mm (42-1/2") for Pole saw, Pole hedge trimmer and Coffee harvester</p>	<p>Cultivator Pengembour 耕耘器 KR400MP Part No. 195716-1 KR401MP Part No. 199185-8</p>	
<p>Rotary scissors Mesin potong rumput 割草器 EM407MP Part No. 191M57-1</p>	<p>Blower Penghembus angin 吹风机组 UB400MP Part No. 191F68-4 UB401MP Part No. 191P75-7</p>	<p>Pole hedge trimmer Pemangkas tanaman 篱笆修剪器 EN401MP (Angle adjustable) Part No. 196341-1</p>			



DUX60ZM3 RM 2,488

DUX60Z RM 1,973

Cordless Multi Function Power Head
Powerhead Pelbagai Fungsi Tanpa Kord
充电式多功动力机

- Multi-tool system consisting of power head and versatile optional attachments is ideal for a wide range of applications

Standard Equipment: Band Assembly, Hex Wrench, Accessory Bag
DUX60ZM3: Brushcutter Attachment EM403, Nylon Cutting Head, 3 Tooth Blade, 3 Tooth Blade Cover, Tool bag, Box Wrench 17, Metal Blade Fixing Tool (Clamp Washer, Nut, Cup)

** ZM3: Without Charger & Battery * Z: Without Charger & Battery*

VIDEO CLIP
Models and specs may vary by country

No Load Speed (RPM) Kelajuan Tanpa Beban 回转速度	High: 0 - 9,700 Med: 0 - 8,200 Low: 0 - 5,700
Dimensions (L x W x H) Dimensi 体积	1,011x320x216mm (39-3/4"x12-5/8"x8-1/2")
Net Weight Berat Bersih 净重	4.1 - 8.7kg (8.9 - 19.2lbs)
Continuous Usage Time (approx.) Masa Penggunaan Berterusan 连续使用时间	Low: 97 min Med: 35 min High: 21 min with BL1850B x2 Grass Trimmer

DUH651Z 650mm (25-1/2")
RM 1,903

Cordless Hedge Trimmer
Pemangkas Tanaman Pagar Tanpa Kord
充电式篱笆树剪

- 5-Position rotating rear handle for increased comfort during vertical and angle trimming

Standard Equipment: Blade Cover

** Z: Without Charger & Battery*

VIDEO CLIP
Models and specs may vary by country

Blade Length Panjang bilah 刀片长度	650mm (25-1/2")
Strokes Per Minute (SPM) Kelajuan Strok 冲程速度	2,000 - 3,600
Tooth Spacing Selang Gigi 牙齿间隔	36mm (1-7/16")
Dimensions (L x W x H) Dimensi 体积	1,135x225x200mm (44-3/4"x8-7/8"x7-7/8")
Net Weight Keberatan 净重	4.7 - 5.5kg (10.3 - 12.0lbs)
Continuous Usage Time (approx.) Masa Penggunaan Berterusan 连续使用时间	75 - 125 min with BL1850B x2

* All list price shown are for reference only (exclude SST).
* Semua harga yang ditunjukkan adalah untuk rujukan sahaja (tidak termasuk SST). 所有显示的建议零售价仅供参考 (不包括SST)。

Cordless
Tempat Masa Bebas

LED Flashlight
Lampu Suis LED
LED LIGHT

Vacuum Cleaner
Penyedut Vakuum
VACUUM

Drilling / Fastening
Gergaji / Pengikat
MIL / 螺絲

Impact Drilling / Demolition
Gergaji / Penakut
MIL / 螺絲

Cutting
Penyedut
VACUUM

Grinding / Sanding
Gergaji / Pasut
MIL / 螺絲

Sawing
Gergaji
MIL / 螺絲

Planing / Routing
Pajuan / Tuguan
MIL / 螺絲

Others
Lain-lain
MIL / 螺絲

Outdoor Power Equipment
Alatan Kuat Daya
MIL / 螺絲

Thakita
MIL / 螺絲



Li-ion Ah 6.0 5.0 4.0 3.0 2.0 1.5

Powerful Blowing Force
Kekuatan Tiupan 强大的吹力
20N*
*Boost Mode

*Masa Penggunaan Berterusan
连续使用时间
Continuous Usage Time with PDC1200
(Variable speed control mode: 0-max)
90 min
(approx.)

UB001CZ
RM 2,292

Battery Powered Blower
Mesin Penghembus Angin Berkuasa Bateri
充电式吹风机



- In Boost mode, 20N max blowing force is always available

Standard Equipment: Shoulder Belt (191J48-4), End Nozzle (412758-3)

- CZ: Without Charger & Battery



Max Air Volume Isipadu Angin Maksimum 最大风量	Boost Mode: 17.6m³/min Cruise Control Mode: 0 - 15.0m³/min
Max Air Velocity Velositi Angin Maksimum 最大风速	Boost Mode: 70m/s Cruise Control Mode: 0 - 60m/s
Avg. Air Velocity Kelajuan Angin Purata 平均风速	Boost Mode: 58m/s Cruise Control Mode: 0 - 50m/s
No Load Speed (RPM) Kelajuan Tanpa Beban 回转速	Boost Mode: 24,000 Cruise Control Mode: 0 - 21,000
Dimensions (L x W x H) Dimensi 体积	960 - 1,060 x 295 x 180mm (37-3/4-41-3/4x11-1/2x7")
Net Weight Berat Bersih 净重	2.6 - 2.9kg (5.7 - 6.5lbs.)
Continuous Usage Time (approx.) Masa Penggunaan Berterusan 连续使用时间	Boost Mode: 17 min Cruise Control Mode: 28 min with PDC01 BL1860B x4 Boost Mode: 60 min Cruise Control Mode: 90 min with PDC1200

DUB363ZV
RM 2,790

Cordless Blower
Mesin Penghembus Angin Tanpa Kord
充电式吹风机



- Able to use both in Blower and Vacuuming applications

Standard Equipment: Vacuum Kit, Flat Nozzle, End Nozzle, Pipe, Band Assembly, Hex Wrench

- ZV: Without Charger & Battery



Max Air Volume Isipadu Angin Maksimum 最大风量	13.4m³/min (473 CFM)
Max Air Velocity Velositi Angin Maksimum 最大风速	65m/s
No Load Speed (RPM) Kelajuan Tanpa Beban 回转速	0 - 7,850
Dimensions (L x W x H) Dimensi 体积	737/786/836x193x415mm (7-7/16"/31"33"x7-5/8"x16-3/8")
Net Weight Berat Bersih 净重	4.5 - 6.6kg (9.9 - 14.6lbs.)
Continuous Usage Time (approx.) Masa Penggunaan Berterusan 连续使用时间	75 min (Mode 1) 9.5 min (Mode 2) with BL1860B x2



DUB362RT2 | **DUB362RM2** | **DUB362Z**
RM 3,577 | RM 3,432 | RM 2,292

Cordless Blower
Mesin Penghembus Angin Tanpa Kord
充电式吹风机



- 6-stage air velocity/volume selection dial with variable speed control trigger

Standard Equipment: Front Nozzle (455914-2)

- RT2: 1x Rapid Charger, 2x 5.0Ah Battery
- RM2: 1x Rapid Charger, 2x 4.0Ah Battery
- Z: Without Charger & Battery



Max Air Volume Isipadu Angin Maksimum 最大风量	13.4m³/min (473CFM)
Max Air Velocity Velositi Angin Maksimum 最大风速	54m/s (120MPH)
No Load Speed (RPM) Kelajuan Tanpa Beban 回转速	11,400 - 21,500
Dimensions (L x W x H) Dimensi 体积	830/880/930x205x295mm (32-3/4"/34-3/4"/36-5/8"x8-1/8"x11-5/8")
Net Weight Berat Bersih 净重	3.5 - 4.2kg (7.7 - 9.3lbs)
Continuous Usage Time (approx.) Masa Penggunaan Berterusan 连续使用时间	75 min with BL1850B x2 (Speed 1)

DUB361Z
RM 1,092

Cordless Blower
Mesin Penghembus Angin Tanpa Kord
充电式吹风机



- Long blowing nozzle with curved tip for optimal blowing performance

Standard Equipment: Shoulder Belt, Nozzle

- Z: Without Charger & Battery



Max Air Volume Isipadu Angin Maksimum 最大风量	High: 4.4m³/min (155CFM) Low: 2.6m³/min (92CFM)
Max Air Velocity Velositi Angin Maksimum 最大风速	High: 93m/s (208MPH) Low: 57m/s (128MPH)
No Load Speed (RPM) Kelajuan Tanpa Beban 回转速	High: 17,000 Low: 10,000
Dimensions (L x W x H) Dimensi 体积	905x141x194mm (35-5/8"x5-5/8"x7-5/8")
Net Weight Berat Bersih 净重	2.6kg (5.9lbs)
Continuous Usage Time (approx.) Masa Penggunaan Berterusan 连续使用时间	Low: 92 min High: 30 min with BL1850B x2

* All list price shown are for reference only (exclude SST).

* Semua harga yang ditunjukkan adalah untuk rujukan sahaja (tidak termasuk SST). 所有显示的建议零售价仅供参考 (不包括SST)。

Cordless
Terdapat Kordless

LED Flashlight
Lampu Cahaya LED
LED0880R

Vacuum Cleaner
Penyedut Vakuum
MUSK1

Drilling / Fastening
Drovo / Pengapit
M10 / M12

Impact Drilling / Demolition
Drovo / Demolisi
M10 / M12

Cutting / Penapis
M10

Grinding / Sanding
Pengisar / Pasut
M10 / M12

Sawing
Drovo
M10

Planing / Routing
Pengapit / Rongkah
M10 / M12

Others
Lain-lain
M10

Outdoor Power Equipment
Alatan Kuasa Luar
M10 - M12

Makita
M10



Li-ion Ah 6.0 5.0 4.0 3.0 2.0 1.5

Cordless High Pressure Washer

Pembersih Tekanan Tinggi Tanpa Kord 充电式高压清洗机

Accessories (Optional)

Aksesori 配件

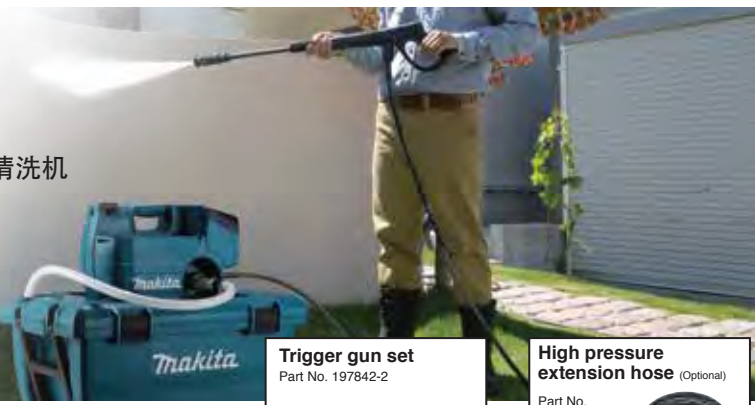
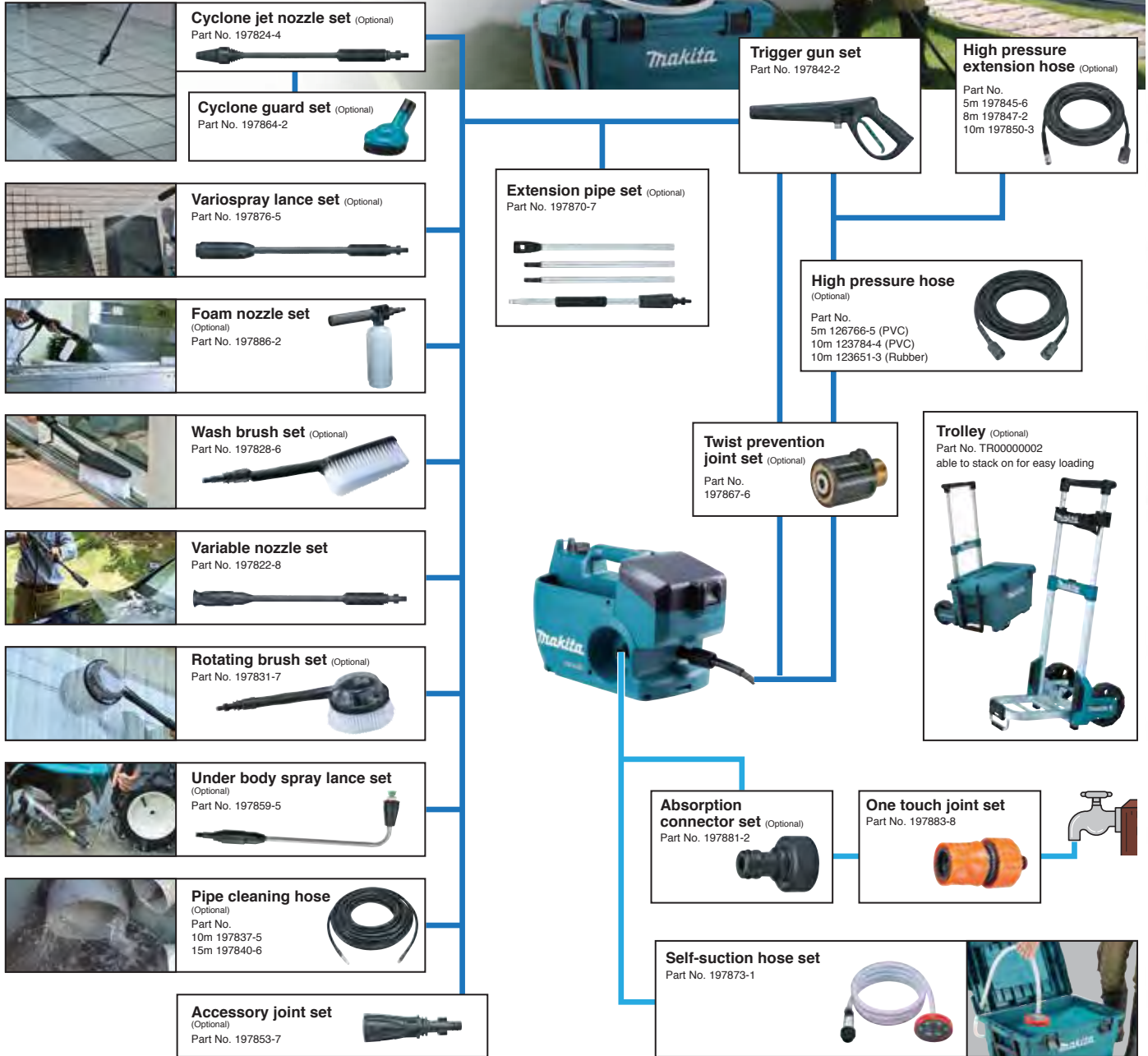
Cyclone jet nozzle set (Optional)
Part No. 197824-4



Cyclone guard set (Optional)
Part No. 197864-2



Variospray lance set (Optional)
Part No. 197876-5



Foam nozzle set (Optional)
Part No. 197886-2



Wash brush set (Optional)
Part No. 197828-6



Variable nozzle set
Part No. 197822-8



Rotating brush set (Optional)
Part No. 197831-7



Under body spray lance set (Optional)
Part No. 197859-5

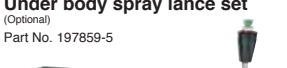

Pipe cleaning hose (Optional)
Part No. 10m 197837-5
15m 197840-6

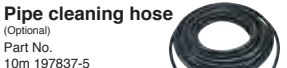

Accessory joint set (Optional)
Part No. 197853-7



Extension pipe set (Optional)
Part No. 197870-7



Trigger gun set
Part No. 197842-2



High pressure extension hose (Optional)
Part No. 5m 197845-6
8m 197847-2
10m 197850-3



High pressure hose (Optional)
Part No. 5m 126766-5 (PVC)
10m 123784-4 (PVC)
10m 123651-3 (Rubber)



Twist prevention joint set (Optional)
Part No. 197867-6



Trolley (Optional)
Part No. TR00000002
able to stack on for easy loading



Absorption connector set (Optional)
Part No. 197881-2



One touch joint set
Part No. 197883-8



Self-suction hose set
Part No. 197873-1



DHW080ZK RM 3,463

Cordless High Pressure Washer
Pembersih Tekanan Tinggi Tanpa Kord
充电式高压清洗机



- High/ Low 2-pressure selection

Standard Equipment: Trigger Gun, High Pressure Hose 5m, Suction Hose, Cleaner Pin, Storage Box, Variable Nozzle, Connector, One Touch Joint

• ZK: Without Charger & Battery



Max Permissible Pressure Tekanan Maksimum 最大水压	8.0MPa
Regular Pressure Tekanan Tetap 固定压力	High: 5.5MPa Low: 3.0MPa
Max Water Flow Aliran Air Maksimum 最大水流量	380L/h (6.3L/min)
Regular Flow Aliran Air Tetap 固定水流量	High: 330L/h (5.5L/min) Low: 240L/h (4.0L/min)
Pump Speed (RPM) Kelajuan Pam 水泵速度	High: 3,450 Low: 2,390
Max Feed Temperature Suhu Maksimum 最高温度	40°C
Tank Kapasiti 容量	50L
Dimensions (L x W x H) Dimensi 体积	438x218x269mm (17-1/4"x8-5/8"x10-5/8")
Net Weight Berat Bersih 净重	7.1 - 7.7kg (15.6 - 17.0lbs.)
Continuous Usage Time (approx.) Masa Penggunaan Berterusan 连续使用时间	Low: 34 min High: 15 min with BL1860B x2

* All list price shown are for reference only (exclude SST).

* Semua harga yang ditunjukkan adalah untuk rujukan sahaja (tidak termasuk SST). 所有显示的建议零售价仅供参考 (不包括SST)。

Cordless
Tempa Apa Saja

LED Flashlight
Lampu Senter LED
- LED BRIGHT

Vacuum Cleaner
Penyedut Vakum
- 2.5L

Drilling / Fastening
Gergaji / Penggulat
- 1/2" / 3/8"

Impact Drilling / Demolition
Gergaji / Pemukul
- 1/2" / 3/8"

Cutting
Pemotong
- 1/2"

Grinding / Smoothing
Gergaji / Pasir
- 1/2" / 3/8"

Sawing
Gergaji
- 1/2"

Planing / Routing
Pengalir / Tegakan
- 1/2" / 3/8"

Others
Lain-lain
- 1/2"

Outdoor Power Equipment
Alatan Kuat Luar
- 1/2"

Makita
1921

18V

LXT

Li-ion Ah 6.0 | 5.0 | 4.0 | 3.0 | 2.0 | 1.5

Cordless Driver Drill

Gerudi Pemutar Skru Tanpa Kord
充电式螺丝起子电钻

All metal gear construction for extra-high transmission durability
Struktur gear semua logam, dengan ketahanan transmisi yang sangat tinggi
全金属齿轮结构, 具有极高的传动耐用性

Mechanical 2-speed transmission
Transmisi 2-kelajuan mekanikal
机械2速变速箱

Twin LED job light with preglow and afterglow functions
Lampu kerja LED berganda dengan fungsi pencahayaan pra dan pencahayaan
具有预发光和余辉功能的双LED工作灯

Variable speed control trigger
Pencetus kawalan kelajuan
触发控制变速

BL MOTOR
Motor tanpa berus
无碳刷马达

XPT
EXTREME PROTECTION TECHNOLOGY

Teknologi Perlindungan Ekstrim
防尘防水滴技术

Belt clip
Mod kawalan manual
手动直接控制模式开关

Max Lock Torque
Pemutaran Tenaga Maksimum
最大扭矩
125N·m



DDF486RTE | **DDF486Z** 13mm (1/2")
RM 2,762 | RM 1,477

Cordless Driver Drill
Gerudi Pemutar Skru Tanpa Kord
充电式螺丝起子电钻



NEW BARU | 新



• Increased performance in continuous heavy-duty applications

Standard Equipment: Side Handle, Belt Clip, (+)(-) Bit, Bit Holder

- RTE: 1x Rapid Charger, 2x 5.0Ah Battery
- Z: Without Charger, Battery & Carrying Case

*Not applicable for Z model

BL MOTOR **XPT**

Capacity Kapasiti 能力	Steel: 13mm (1/2") Wood (Auger-Bit): 50mm (2") Wood (Hole Saw): 152mm (6") Siding Board: 170mm (6-11/16") High: 0 - 2,100 Low: 0 - 550
No Load Speed (RPM) Kelajuan Tanpa Beban 回转速	
Max Fastening Torque Maksimum Tenaga Pemutaran Pengancing 最快扭力	Hard: 130N·m (1,150in.lbs.) Soft: 65N·m (580in.lbs.)
Max Lock Torque Pemutaran Tenaga Maksimum 最大扭矩	125N·m (1,100in.lbs.)
Dimensions (L x W x H) Dimensi 体积	178x81x265mm (7x3-3/16x10-3/8")
Net Weight Berat Bersih 淨重	2.3 - 2.6kg (5.1 - 5.7lbs.)
Work Amount (approx.) Jumlah Kerja 工作量	710 holes with BL1850B Wood bit ø21mm (30mm thick melapi) High Speed

DDF487RAJ | **DDF487Z** 13mm (1/2")
RM 1,670 | RM 768

Cordless Driver Drill
Gerudi Pemutar Skru Tanpa Kord
充电式螺丝起子电钻



NEW BARU | 新



• Compact design at only 150 mm long for increased operability

Standard Equipment: Belt Clip, (+)(-) Bit

- RAJ: 1x Rapid Charger, 2x 2.0Ah Battery, 1x Makpac Connector Box
- Z: Without Charger, Battery & Carrying Case

*Not applicable for Z model

BL MOTOR **XPT**

Capacity Kapasiti 能力	Steel: 13mm (1/2") Wood (Hole Saw): 51mm (2") Wood (Self-Feed Bit): 35mm (1-3/8") Wood (Auger Bit): 36mm (1-7/16") High: 0 - 1,700 Low: 0 - 500
No Load Speed (RPM) Kelajuan Tanpa Beban 回转速	
Max Fastening Torque Maksimum Tenaga Pemutaran Pengancing 最快扭力	Hard: 40N·m (350in.lbs.) Soft: 25N·m (220in.lbs.)
Max Lock Torque Pemutaran Tenaga Maksimum 最大扭矩	40N·m (350in.lbs.)
Dimensions (L x W x H) Dimensi 体积	150x81x248mm (5-7/8x3-3/16x9-3/4")
Net Weight Berat Bersih 淨重	1.3 - 1.6kg (2.9 - 3.5lbs.)
Work Amount (approx.) Jumlah Kerja 工作量	640 holes with BL1820B Wood bit ø9mm (30mm thick melapi) High Speed

* All list price shown are for reference only (exclude SST).

* Semua harga yang ditunjukkan adalah untuk rujukan sahaja (tidak termasuk SST). 所有显示的建议零售价仅供参考 (不包括SST)。

Cordless
Terdapat dalam kategori ini

LED Flashlight
Lampu Cahaya LED
LED 1000lm

Vacuum Cleaner
Penyedut Vakuum
1000W

Drilling / Fastening
Druai / Pengikat
1000W

Impact Drilling / Demolition
Druai / Demolisi
1000W

Cutting
Pemotongan
1000W

Grinding / Sanding
Pengisar / Pasir
1000W

Sawing
Druai
1000W

Planing / Routing
Pengisar / Runcing
1000W

Others
Lain-lain

Outdoor Power Equipment
Alat Kuasa Luar
1000W

Makita
1000W



Li-ion Ah 6.0 5.0 4.0 3.0 2.0 1.5

DDF481RTE RM 2,762	DDF481RME RM 2,615	DDF481RFE RM 2,452	DDF481Z 13mm (1/2") RM 1,477
------------------------------	------------------------------	------------------------------	--

Cordless Driver Drill
Gerudi Pemutar Skru Tanpa Kord
充电式螺丝起子电钻



- 21 Clutch settings and drill mode for added fastening control

Standard Equipment: Side Grip, Belt Clip, (+)(-) Bit, Bit Holder

- RTE: 1x Rapid Charger, 2x 5.0Ah Battery
- RME: 1x Rapid Charger, 2x 4.0Ah Battery
- RFE: 1x Rapid Charger, 2x 3.0Ah Battery
- Z: Without Charger, Battery & Carrying Case

BL MOTOR XPT

Capacity Kapasiti 能力	Steel: 13mm (1/2") Wood: 76mm (3")
Chuck Capacity Kapasiti Chuck 夹头能力	1.5 - 13mm (1/16 - 1/2")
No Load Speed (RPM) Kelajuan Tanpa Beban 回转数	High: 0 - 2,100 Low: 0 - 550
Max Fastening Torque Maksimum Tenaga Pemutaran Pengancing 最快扭力	Hard: 115N-m (1,020in.lbs.) Soft: 60N-m (530in.lbs.)
Max Lock Torque Pemutaran Tenaga Maksimum 最大扭矩	125N-m (1,090in.lbs.)
Max Output Keluaran Maksima 最大输出	640W
Dimensions (L x W x H) Dimensi 体积	205x79x266mm (8-1/8"x3-1/8"x10-1/2")
Net Weight Berat Bersih 淨重	2.7 - 3.0kg (5.9 - 6.6lbs)
Work Amount (approx.) Jumlah Kerja 工作量	630 holes with BL1850B Wood bit ø21mm (25mm thick Luan)

DDF458RME RM 2,138	DDF458RFE RM 1,973	DDF458Z 13mm (1/2") RM 998	440 W
------------------------------	------------------------------	--------------------------------------	-------

Cordless Driver Drill
Gerudi Pemutar Skru Tanpa Kord
充电式螺丝起子电钻



- Mechanical 2-speed transmission covers a wide range of drilling and fastening applications

Standard Equipment: Side Grip, (+)(-) Bit, Belt Clip, Bit Holder

- RME: 1x Rapid Charger, 2x 4.0Ah Battery
- RFE: 1x Rapid Charger, 2x 3.0Ah Battery
- Z: Without Charger, Battery & Carrying Case

XPT

Capacity Kapasiti 能力	Steel: 13mm (1/2") Wood: 76mm (3")
No Load Speed (RPM) Kelajuan Tanpa Beban 回转数	High: 0-2,000 Low: 0-400
Max Fastening Torque Maksimum Tenaga Pemutaran Pengancing 最快扭力	Hard: 91N-m Soft: 58N-m
Max Lock Torque Pemutaran Tenaga Maksimum 最大扭矩	84N-m (750in.lbs.)
Dimensions (L x W x H) Dimensi 体积	225x79x259mm (8-7/8"x3-1/8"x10-1/4")
Net Weight Berat Bersih 淨重	2.1 - 2.5kg (4.7 - 5.4lbs)
Work Amount (approx.) Jumlah Kerja 工作量	500 holes with BL1850B Wood bit ø21mm (25mm thick Luan)

DDF482RME RM 1,833	DDF482RFE RM 1,670	DDF482Z 13mm (1/2") RM 695	440 W
------------------------------	------------------------------	--------------------------------------	-------

Cordless Driver Drill
Gerudi Pemutar Skru Tanpa Kord
充电式螺丝起子电钻



- High speed model with compact and lightweight design

Standard Equipment: Belt Clip, (+)(-) Bit

- RME: 1x Rapid Charger, 2x 4.0Ah Battery
- RFE: 1x Rapid Charger, 2x 3.0Ah Battery
- Z: Without Charger, Battery & Carrying Case

XPT

Capacity Kapasiti 能力	Steel: 13mm (1/2") Wood: 38mm (1-1/2")
Chuck Capacity Kapasiti Chuck 夹头能力	1.5 - 13mm (1/16 - 1/2")
No Load Speed (RPM) Kelajuan Tanpa Beban 回转数	High: 0 - 1,900 Low: 0 - 600
Max Fastening Torque Maksimum Tenaga Pemutaran Pengancing 最快扭力	Hard: 62N-m (550in.lbs.) Soft: 36N-m (320in.lbs.)
Max Lock Torque Pemutaran Tenaga Maksimum 最大扭矩	54N-m (480in.lbs.)
Dimensions (L x W x H) Dimensi 体积	185x79x249mm (7-1/4"x3-1/8"x9-3/4")
Net Weight Berat Bersih 淨重	1.5 - 1.8kg (3.2 - 4.0lbs)
Work Amount (approx.) Jumlah Kerja 工作量	781 holes with BL1850B Brad Point Wood bit ø8mm (1" Depth Mixed wood)

DDF484RTE RM 2,242	DDF484RME RM 2,097	DDF484RFE RM 1,932	DDF484Z 13mm (1/2") RM 957
------------------------------	------------------------------	------------------------------	--------------------------------------

Cordless Driver Drill
Gerudi Pemutar Skru Tanpa Kord
充电式螺丝起子电钻



- Delivers 25% more drilling, driving and fastening speed

Standard Equipment: Belt Clip, (+)(-) Bit

- RTE: 1x Rapid Charger, 2x 5.0Ah Battery
- RME: 1x Rapid Charger, 2x 4.0Ah Battery
- RFE: 1x Rapid Charger, 2x 3.0Ah Battery
- Z: Without Charger, Battery & Carrying Case

BL MOTOR XPT

Capacity Kapasiti 能力	Steel: 13mm (1/2") Wood: 38mm (1-1/2")
Chuck Capacity Kapasiti Chuck 夹头能力	1.5 - 13mm (1/16 - 1/2")
No Load Speed (RPM) Kelajuan Tanpa Beban 回转数	High: 0 - 2,000 Low: 0 - 500
Max Fastening Torque Maksimum Tenaga Pemutaran Pengancing 最快扭力	Hard: 54N-m (480in.lbs.) Soft: 30N-m (270in.lbs.)
Max Lock Torque Pemutaran Tenaga Maksimum 最大扭矩	60N-m (530in.lbs.)
Dimensions (L x W x H) Dimensi 体积	172x79x261mm (6-3/4"x3-1/8"x10-1/4")
Net Weight Berat Bersih 淨重	1.5 - 1.8kg (3.3 - 4.0lbs)
Work Amount (approx.) Jumlah Kerja 工作量	1550 holes with BL1850B Wood bit ø9mm (30mm thick Luan)

DDF485RFE RM 1,760	DDF485Z 13mm (1/2") RM 785
------------------------------	--------------------------------------

Cordless Driver Drill
Gerudi Pemutar Skru Tanpa Kord
充电式螺丝起子电钻



- Variable 2-speed for a wide range of drilling and fastening applications

Standard Equipment: Belt Clip, (+)(-) Bit

- RFE: 1x Rapid Charger, 2x 3.0Ah Battery
- Z: Without Charger, Battery & Carrying Case

BL MOTOR XPT

Capacity Kapasiti 能力	Steel: 13mm (1/2") Wood: 38mm (1-1/2")
Chuck Capacity Kapasiti Chuck 夹头能力	1.5 - 13mm (1/16 - 1/2")
No Load Speed (RPM) Kelajuan Tanpa Beban 回转数	High: 0- 1,900 Low: 0 - 500
Max Fastening Torque Maksimum Tenaga Pemutaran Pengancing 最快扭力	Hard: 50N-m (440in.lbs.) Soft: 27N-m (240in.lbs.)
Max Lock Torque Pemutaran Tenaga Maksimum 最大扭矩	50N-m (440in.lbs.)
Max Output Keluaran Maksima 最大输出	350W
Clutch Torque Setting Tetapan Pemutaran 扭转设置	1.0 - 5.0N-m (9 - 44in.lbs.)
Dimensions (L x W x H) Dimensi 体积	169x79x255mm (7-1/8"x3-1/8"x10")
Net Weight Berat Bersih 淨重	1.4 - 1.7kg (3.1 - 3.8lbs.)
Work Amount (approx.) Jumlah Kerja 工作量	1400 pcs with BL1850B Auger Bit ø15mm (30mm thick Melapi)

* All list price shown are for reference only (exclude SST).

* Semua harga yang ditunjukkan adalah untuk rujukan sahaja (tidak termasuk SST). 所有显示的建议零售价仅供参考 (不包括SST)。

Cordless
LED Flashlight
Vacuum Cleaner
Drilling / Fastening
Impact Drilling / Demolition
Cutting / Trimming
Grinding / Sanding
Sawing / Cutting
Planing / Routing
Others
Outdoor Power Equipment





Li-ion Ah 6.0 | 5.0 | 4.0 | 3.0 | 2.0 | 1.5

DDF459RME **DDF459Z** 13mm (1/2")
RM 1,853 RM 713

Cordless Driver Drill
Gerudi Pemutar Skru Tanpa Kord
充电式螺丝起子电钻



- Brushless motor delivers up to 50% longer run time per charge

Standard Equipment: Belt Clip, (+)(-) Bit

- RME: 1x Rapid Charger, 2x 4.0Ah Battery
- Z: Without Charger, Battery & Carrying Case



Capacity Kapasiti 能力	Steel: 13mm (1/2") Wood: 38mm (1-1/2")
Chuck Capacity Kapasiti Chuck 夹头能力	1.5 - 13mm (1/16 - 1/2")
No Load Speed (RPM) Kelajuan Tanpa Beban 回转数	High: 0 - 1,500 Low: 0 - 400
Max Fastening Torque Maksimum Tenaga Pemutaran Pengancing 最快扭力	Hard: 45N-m (400in.lbs.) Soft: 25N-m (220in.lbs.)
Max Lock Torque Pemutaran Tenaga Maksimum 最大扭力	45N-m (400in.lbs.)
Dimensions (L x W x H) Dimensi 体积	179x78x256mm (7"x3-1/16"x10-1/8")
Net Weight Berat Bersih 净重	1.4 - 1.7kg (3.1 - 3.8lbs)
Work Amount (approx.) Jumlah Kerja 工作量	1470 pcs with BL1850B Auger Bit ø15mm (30mm thick MelapI)

DDF453RME **DDF453RFE** **DDF453SYE** **DDF453Z** 13mm (1/2")
RM 1,643 RM 1,478 RM 1,343 RM 503

Cordless Driver Drill
Gerudi Pemutar Skru Tanpa Kord
充电式螺丝起子电钻



- All metal gear construction ensures high transmission durability

Standard Equipment: (+)(-) Bit

- RME: 1x Rapid Charger, 2x 4.0Ah Battery
- RFE: 1x Rapid Charger, 2x 3.0Ah Battery
- SYE: 1x Standard Charger, 2x 1.5Ah Battery
- Z: Without Charger, Battery, Bit & Carrying Case



Capacity Kapasiti 能力	Steel: 13mm (1/2") Wood: 36mm (1-7/16")
No Load Speed (RPM) Kelajuan Tanpa Beban 回转数	High: 0-1,300 Low: 0-400
Max Fastening Torque Maksimum Tenaga Pemutaran Pengancing 最快扭力	Hard: 42N-m Soft: 27N-m
Max Lock Torque Pemutaran Tenaga Maksimum 最大扭力	38N-m (340in.lbs.)
Dimensions (L x W x H) Dimensi 体积	222x79x244mm (8-3/4"x3-1/8"x9-5/8")
Net Weight Berat Bersih 净重	1.7 - 2.0kg (3.7 - 4.4lbs)
Work Amount (approx.) Jumlah Kerja 工作量	720 pcs with BL1850B Wood screw ø4.1 x 38mm

DDF483RTE **DDF483RME** **DDF483RFE** **DDF483Z** 13mm (1/2")
RM 2,052 RM 1,907 RM 1,743 RM 768

Cordless Driver Drill
Gerudi Pemutar Skru Tanpa Kord
充电式螺丝起子电钻



- BL motor delivers 40N-m of max torque

Standard Equipment: Belt Clip, (+)(-) Bit

- RTE: 1x Rapid Charger, 2x 5.0Ah Battery
- RME: 1x Rapid Charger, 2x 4.0Ah Battery
- RFE: 1x Rapid Charger, 2x 3.0Ah Battery
- Z: Without Charger, Battery & Carrying Case



Capacity Kapasiti 能力	Steel: 13mm (1/2") Wood: 36mm (1-7/16")
Chuck Capacity Kapasiti Chuck 夹头能力	1.5 - 13mm (1/16 - 1/2")
No Load Speed (RPM) Kelajuan Tanpa Beban 回转数	High: 0 - 1,700 Low: 0 - 500
Max Fastening Torque Maksimum Tenaga Pemutaran Pengancing 最快扭力	Hard: 40N-m (350in.lbs.) Soft: 23N-m (210in.lbs.)
Max Lock Torque Pemutaran Tenaga Maksimum 最大扭力	40N-m (350in.lbs.)
Dimensions (L x W x H) Dimensi 体积	162x79x247mm (6-3/8"x3-1/8"x9-3/4")
Net Weight Berat Bersih 净重	1.2 - 1.6kg (2.7 - 3.4lbs)
Work Amount (approx.) Jumlah Kerja 工作量	1666 pcs with BL1850B Wood Bit ø9mm (30mm thick Lauan)

DDF083RTE **DDF083RFE** **DDF083Z** 13mm (1/2")
RM 2,007 RM 1,698 RM 722

Cordless Driver Drill
Gerudi Pemutar Skru Tanpa Kord
充电式螺丝起子电钻



- Mechanical 2-speed transmission covers a wide range of drilling and fastening applications

Standard Equipment: Belt Clip, Phillips Bit

- RTE: 1x Rapid Charger, 2x 5.0Ah Battery
- RFE: 1x Rapid Charger, 2x 3.0Ah Battery
- Z: Without Charger, Battery & Carrying Case



Capacity Kapasiti 能力	Steel: 13mm (1/2") Wood: 36mm (1-7/16")
Chuck Capacity Kapasiti Chuck 夹头能力	6.35mm (1/4")
No Load Speed (RPM) Kelajuan Tanpa Beban 回转数	High: 0 - 1,700 Low: 0 - 500
Max Fastening Torque Maksimum Tenaga Pemutaran Pengancing 最快扭力	Hard: 40N-m (350in.lbs.) Soft: 23N-m (210in.lbs.)
Max Lock Torque Pemutaran Tenaga Maksimum 最大扭力	40N-m (350in.lbs.)
Dimensions (L x W x H) Dimensi 体积	124x79x247mm (4-7/8"x3-1/8"x9-3/4")
Net Weight Berat Bersih 净重	1.1 - 1.4kg (2.4 - 3.0lbs)
Work Amount (approx.) Jumlah Kerja 工作量	1666 pcs with BL1850B Wood Bit ø9mm (30mm thick Lauan)

Model No. 型号	Capacity Kapasiti 能力		No Load Speed (rpm) Kelajuan Tanpa Beban 回转数	Mechanical Speed Mekanikal Kelajuan 机械速度	Torque Setting Tetapan Pemutaran 扭转设置	Max. Fastening Torque Maksimum Tenaga Pemutaran Pengancing 最快扭力	Overall Length (mm) Panjang Keseluruhan 总长度	Net Weight Berat Bersih 净重	BL MOTOR	XPT
	Steel	Wood								
DDF486	13mm	76mm	0-2,100 / 0-550	2 Speed	21	Hard: 130 / Soft: 65	178	2.3kg (5.1lbs)	●	●
DDF481	13mm	76mm	0-2,100 / 0-550	2 Speed	21	Hard: 115 / Soft: 60	205	2.7kg (5.9lbs)	●	●
DDF458	13mm	76mm	0-2,000 / 0-400	2 Speed	21	Hard: 91 / Soft: 58	225	2.1kg (4.7lbs)	●	●
DDF482	13mm	38mm	0 - 1,900 / 0 - 600	2 Speed	21	Hard: 62 / Soft: 36	185	1.5kg (3.2lbs)	●	●
DDF484	13mm	38mm	0-2,000 / 0-500	2 Speed	21	Hard: 54 / Soft: 30	172	1.5kg (3.3lbs)	●	●
DDF485	13mm	38mm	0-1,900 / 0-500	2 Speed	21	Hard: 50 / Soft: 27	169	1.4kg (3.1lbs)	●	●
DDF459	13mm	38mm	0-1,500 / 0-400	2 Speed	16	Hard: 45 / Soft: 25	179	1.4kg (3.1lbs)	●	●
DDF453	13mm	36mm	0-1,300 / 0-400	2 Speed	16	Hard: 42 / Soft: 27	222	1.7kg (3.7lbs)	●	●
DDF487	13mm	36mm	0-1,700 / 0-500	2 Speed	20	Hard: 40 / Soft: 25	150	1.3kg (2.9lbs)	●	●
DDF483	13mm	36mm	0-1,700 / 0-500	2 Speed	20	Hard: 40 / Soft: 23	162	1.2kg (2.7lbs)	●	●
DDF083	13mm	36mm	0-1,700 / 0-500	2 Speed	20	Hard: 40 / Soft: 23	124	1.1kg (2.4lbs)	●	●

* All list price shown are for reference only (exclude SST).

* Semua harga yang ditunjukkan adalah untuk rujukan sahaja (tidak termasuk SST). 所有显示的建议零售价仅供参考 (不包括SST)。

Cordless
Terdapat Tanpa Kord

LED Flashlight
Lampu Cahaya LED
LED BRIGHT

Vacuum Cleaner
Penyedut Haba
BUKUK

Drilling / Fastening
Dua / Pengancing
M10 / 1/2"

Impact Drilling / Demolition
Dua / Demolish
反冲 / 拆卸

Cutting
Pemotong
1/2"

Grinding / Sanding
Tungku / Sanding
200 / 1/2"

Sawing
Gergaji
1/2"

Planing / Routing
Pengaliran / Runcing
M10 / 1/2"

Others
Lain-lain

Outdoor Power Equipment
Alat Kuasa Luar
M10-7/8"

Makita
Makita

BRUSHLESS MOTOR

Motor tanpa berus 无碳刷马达

- Maintenance-free due to no brush
- Life time work amount of a battery is increased
- Durable against long continuous operation
- More work amount on a single full battery charge

penyenggaraan mudah tanpa proses penggantian berus karbon. Alat yang menggunakan motor berus BL tidak mengalami geseran haba, dengan itu menjadikan bateri lebih tahan lama. Untuk menukarkan tugas yang berulang, pastikan anda menggunakan alat yang menggunakan motor berus BL. Oleh kerana itu, setiap kali anda mengisi bateri, masa kerja akan lebih lama.



BRUSHED MOTOR

Motor dengan berus 有刷马达

- High power-to-weight ratio obtained by employing 4-pole motor

Berkuasa tinggi dengan motor 4-pole

采用4极马达, 高功率

4-POLE MOTOR **2-POLE MOTOR**



Max Fastening Torque

Maksimum Tenaga Pemutaran Pengancing 最大扭矩

Soft Joint

65 N-m

60 N-m

50

40

30

27 N-m

25 N-m

25 N-m

20

10

DDF486 **BL MOTOR**
Cordless Driver Drill
 Gerudi Pemutar Skru tanpa Kord 充电式螺丝起子电钻

DHP481 **BL MOTOR**
Cordless Hammer Driver Drill
 Tukul Pemutar Skru Bergerudi tanpa Kord 充电式冲击螺丝起子电钻

DDF481 **BL MOTOR**
Cordless Driver Drill
 Gerudi Pemutar Skru tanpa Kord 充电式螺丝起子电钻

DHP484 **BL MOTOR**
Cordless Hammer Driver Drill
 Tukul Pemutar Skru Bergerudi tanpa Kord 充电式冲击螺丝起子电钻

DDF484 **BL MOTOR**
Cordless Driver Drill
 Gerudi Pemutar Skru tanpa Kord 充电式螺丝起子电钻

DHP485 **BL MOTOR**
Cordless Hammer Driver Drill
 Tukul Pemutar Skru Bergerudi tanpa Kord 充电式冲击螺丝起子电钻

DDF485 **BL MOTOR**
Cordless Driver Drill
 Gerudi Pemutar Skru tanpa Kord 充电式螺丝起子电钻

DHP459 **BL MOTOR**
Cordless Hammer Driver Drill
 Tukul Pemutar Skru Bergerudi tanpa Kord 充电式冲击螺丝起子电钻

DDF459 **BL MOTOR**
Cordless Driver Drill
 Gerudi Pemutar Skru tanpa Kord 充电式螺丝起子电钻

DHP487 **BL MOTOR**
Cordless Hammer Driver Drill
 Tukul Pemutar Skru Bergerudi tanpa Kord 充电式冲击螺丝起子电钻

DDF487 **BL MOTOR**
Cordless Driver Drill
 Gerudi Pemutar Skru tanpa Kord 充电式螺丝起子电钻

DHP483 **BL MOTOR**
Cordless Hammer Driver Drill
 Tukul Pemutar Skru Bergerudi tanpa Kord 充电式冲击螺丝起子电钻

DDF483 | DDF083 **BL MOTOR**
Cordless Driver Drill
 Gerudi Pemutar Skru tanpa Kord 充电式螺丝起子电钻



Max Fastening Torque

Maksimum Tenaga Pemutaran Pengancing 最大扭矩

Hard Joint

130 N-m

115 N-m

90

80

70

60

54 N-m

50 N-m

45 N-m

40 N-m

40 N-m

30

20

10

DHP458 **BL MOTOR**
Cordless Hammer Driver Drill
 Tukul Pemutar Skru Bergerudi tanpa Kord 充电式冲击螺丝起子电钻

DDF458 **BL MOTOR**
Cordless Driver Drill
 Gerudi Pemutar Skru tanpa Kord 充电式螺丝起子电钻

DHP482 **BL MOTOR**
Cordless Hammer Driver Drill
 Tukul Pemutar Skru Bergerudi tanpa Kord 充电式冲击螺丝起子电钻

DDF482 **BL MOTOR**
Cordless Driver Drill
 Gerudi Pemutar Skru tanpa Kord 充电式螺丝起子电钻

DHP453 **BL MOTOR**
Cordless Hammer Driver Drill
 Tukul Pemutar Skru Bergerudi tanpa Kord 充电式冲击螺丝起子电钻

DDF453 **BL MOTOR**
Cordless Driver Drill
 Gerudi Pemutar Skru tanpa Kord 充电式螺丝起子电钻

Max Fastening Torque

Maksimum Tenaga Pemutaran Pengancing 最大扭矩

Soft Joint

58 N-m

50

40

36 N-m

30

27 N-m

20

10

* All list price shown are for reference only (exclude SST).

* Semua harga yang ditunjukkan adalah untuk rujukan sahaja (tidak termasuk SST). 所有显示的建议零售价仅供参考 (不包括SST)。

Cordless
Torque-Apex Motor

LED Flashlight
Tunjuk Cahaya LED
- LED BRIGHT

Vacuum Cleaner
Penyedut Vakuam
- BLU-5

Drilling / Fastening
Galian / Pengancing
- M10 / M12

Impact Drilling / Demolition
Galian / Pemusnah
- 1/2" M14 / M16

Cutting
Pemotong
- 1/2"

Grinding / Sanding
Gilingan / Pasut
- 1/2" / 3/8"

Sawing
Gergaji
- 1/2"

Planing / Routing
Pajuaran / Trogam
- 1/2" / 3/8"

Others
Lain-lain
- 1/2"

Outdoor Power Equipment
Alatan Kuasa Luar
- 1/2" / 3/8"

makita
- 1/2"

18V

LXT

Li-ion Ah 6.0 | 5.0 | 4.0 | 3.0 | 2.0 | 1.5

Cordless Hammer Driver Drill

Tukul Pemutar Skru Bergerudi Tanpa Kord
充电式冲击螺丝起子电钻

BL MOTOR
Motor tanpa berus
无碳刷马达

XPT
EXTREME PROTECTION TECHNOLOGY

Teknologi Perlindungan Ekstrim
防尘防水滴技术



Light Weight
Berat Bersih 淨重
1.4kg

Max Lock Torque
Pemutaran Tenaga Maksimum
最大扭力
40N·m

Compact



Twin LED job light with preglow and afterglow functions

Lampu kerja LED berganda dengan fungsi pencahayaan pra dan pencahayaan
具有预发光和余辉功能的双LED工作灯



Variable speed control trigger

Pencetus kawalan kelajuan
触发控制变速



Mechanical 2-speed gearing

Transmisi 2-kelajuan mekanikal
机械2速变速箱

DHP487RAJ | **DHP487Z** 13mm (1/2")
RM 1,718 | RM 817

Cordless Hammer Driver Drill

Tukul Pemutar Skru Bergerudi Tanpa Kord
充电式冲击螺丝起子电钻

• Compact design at only 164mm long for increased operability

Standard Equipment: Belt Clip, (+)(-) Bit

• RAJ: 1x Rapid Charger, 2x 2.0Ah Battery, 1x Makpac Connector Box
• Z: Without Charger, Battery & Carrying Case

NEW
BARU | 新



Capacity Kapasiti 能力	Steel: 13mm (1/2") Masonry: 13mm (1/2") Wood (Self-Feed Bit): 35 mm (1-3/8") Wood (Auger Bit): 36 mm (1-7/16") Wood (Hole Saw): 51 mm (2") 1.5 - 13 mm (1/16 - 1/2")
Chuck Capacity Kapasiti Chuck 夹头能力	
Impacts Per Minute (IPM) Impak Per Minit 冲击数	High: 0 - 25,500 Low: 0 - 7,500
No Load Speed (RPM) Kelajuan Tanpa Beban 回转数	High: 0 - 1,700 Low: 0 - 500
Max Fastening Torque Maksimum Tenaga Pemutaran Pengancing 最快扭力	Hard: 40N·m (350 in.lbs.) Soft: 25N·m (220 in.lbs.)
Max Lock Torque Pemutaran Tenaga Maksimum 最大扭力	40N·m (350in.lbs.)
Dimensions (L x W x H) Dimensi 体积	164x81x248mm (6-1/2x3-3/16x9-3/4")
Net Weight Berat Bersih 淨重	1.4 - 1.7kg (3.1 - 3.7lbs.)
Work Amount (approx.) Jumlah Kerja 工作量	640 holes with BL1820B Wood bit ø9mm (30mm thick melapi) High Speed

* All list price shown are for reference only (exclude SST).

* Semua harga yang ditunjukkan adalah untuk rujukan sahaja (tidak termasuk SST). 所有显示的建议零售价仅供参考 (不包括SST)。

Cordless Impact Driver
LED Flashlight
Vacuum Cleaner
Drilling / Fastening
Impact Drilling / Demolition
Cutting
Grinding / Sanding
Sawing
Planing / Routing
Drivers





Li-ion Ah 6.0 5.0 4.0 3.0 2.0 1.5

DHP481RTE | **DHP481RFE** | **DHP481Z** 13mm (1/2")
 RM 2,817 | RM 2,507 | RM 1,532

Cordless Hammer Driver Drill
 Tukul Pemutar Skru Bergerudi Tanpa Kord
 充电式冲击螺丝起子电钻



- 0-31,500 IPM for fast hammer drilling in masonry materials



VIDEO CLIP
 Models and specs may vary by country

DHP481

Standard Equipment: Depth Gauge, Side Grip, Belt Clip, (+) Bit, Bit Holder

- RTE: 1x Rapid Charger, 2x 4.0Ah Battery
- RFE: 1x Rapid Charger, 2x 3.0Ah Battery
- Z: Without Charger, Battery & Carrying Case



*Not applicable for Z model



Capacity Kapasiti 能力	Steel: 13mm (1/2") Wood: 76mm (3") Masonry: 16mm (5/8")
Chuck Capacity Kapasiti Chuck 夹头能力	1.5 - 13mm (1/16 - 1/2")
Impacts Per Minute (IPM) Impak Per Minit 冲击数	High: 0 - 31,500 Low: 0 - 8,250
No Load Speed (RPM) Kelajuan Tanpa Beban 回转数	High: 0 - 2,100 Low: 0 - 550
Max Fastening Torque Maksimum Tenaga Pemutaran Pengancing 最快扭力	Hard: 115N-m (1,020in.lbs.) Soft: 60N-m (530in.lbs.)
Max Lock Torque Pemutaran Tenaga Maksimum 最大扭力	125N-m (1,090in.lbs.)
Dimensions (L x W x H) Dimensi 体积	205x79x249mm (8-1/8"x3-1/8"x9-3/4")
Net Weight Berat Bersih 净重	2.7 - 3.0kg (6.0 - 6.7lbs)
Work Amount (approx.) Jumlah Kerja 工作量	630 pcs with BL1850B Wood Screw ø21 x 25mm

DHP458RME | **DHP458RFE** | **DHP458Z** 13mm (1/2") **440mm**
 RM 2,188 | RM 2,023 | RM 1,048

Cordless Hammer Driver Drill
 Tukul Pemutar Skru Bergerudi Tanpa Kord
 充电式冲击螺丝起子电钻

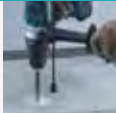

- All metal gears and aluminum gear housing for maximum jobsite durability

Standard Equipment: (+)(-) Bit, Side Grip, Depth Rod, Bit Holder

- RME: 1x Rapid Charger, 2x 4.0Ah Battery
- RFE: 1x Rapid Charger, 2x 3.0Ah Battery
- Z: Without Charger, Battery & Carrying Case



*Not applicable for Z model



Capacity Kapasiti 能力	Steel: 13mm (1/2") Wood: 76mm (3") Masonry: 16mm (5/8")
No Load Speed (RPM) Kelajuan Tanpa Beban 回转数	High: 0-2,000 Low: 0-400
Impacts Per Minute (IPM) Impak Per Minit 冲击数	High: 0-30,000 Low: 0-6,000
Max Fastening Torque Maksimum Tenaga Pemutaran Pengancing 最快扭力	Hard: 91N-m Soft: 58N-m
Max Lock Torque Pemutaran Tenaga Maksimum 最大扭力	84N-m (750in.lbs.)
Dimensions (L x W x H) Dimensi 体积	225x79x259mm (8-7/8"x3-1/8"x10-1/4")
Net Weight Berat Bersih 净重	2.2 - 2.6kg (4.9 - 5.7lbs)
Work Amount (approx.) Jumlah Kerja 工作量	500 pcs with BL1850B Wood Screw ø9 x 25mm

DHP482RME | **DHP482RFE** | **DHP482Z** 13mm (1/2") **440mm**
 RM 1,870 | RM 1,707 | RM 732

Cordless Hammer Driver Drill
 Tukul Pemutar Skru Bergerudi Tanpa Kord
 充电式冲击螺丝起子电钻



- High speed model with compact and lightweight design

Standard Equipment: Belt Clip, (+)(-) Bit

- RME: 1x Rapid Charger, 2x 4.0Ah Battery
- RFE: 1x Rapid Charger, 2x 3.0Ah Battery
- Z: Without Charger, Battery & Carrying Case



*Not applicable for Z model



Capacity Kapasiti 能力	Steel: 13mm (1/2") Wood: 38mm (1-1/2") Masonry: 13mm (1/2")
Chuck Capacity Kapasiti Chuck 夹头能力	1.5 - 13mm (1/16 - 1/2")
Impacts Per Minute (IPM) Impak Per Minit 冲击数	High: 0 - 28,500 Low: 0 - 9,000
No Load Speed (RPM) Kelajuan Tanpa Beban 回转数	High: 0 - 1,900 Low: 0 - 600
Max Fastening Torque Maksimum Tenaga Pemutaran Pengancing 最快扭力	Hard: 62N-m (550 in.lbs.) Soft: 36N-m (320 in.lbs.)
Max Lock Torque Pemutaran Tenaga Maksimum 最大扭力	54N-m (480in.lbs.)
Dimensions (L x W x H) Dimensi 体积	198x79x249mm (7-3/4"x3-1/8"x9-3/4")
Net Weight Berat Bersih 净重	1.5 - 1.8kg (3.4 - 4.1lbs)
Work Amount (approx.) Jumlah Kerja 工作量	781 holes with BL1850B Brad Point Wood Bit ø8mm (1" Depth Mixed wood)

DHP484RME | **DHP484RFE** | **DHP484Z** 13mm (1/2")
 RM 2,152 | RM 1,987 | RM 1,012

Cordless Hammer Driver Drill
 Tukul Pemutar Skru Bergerudi Tanpa Kord
 充电式冲击螺丝起子电钻



- 0-30,000 IPM for fast hammer drilling in masonry materials

Standard Equipment: Belt Clip, (+)(-) Bit

- RME: 1x Rapid Charger, 2x 4.0Ah Battery
- RFE: 1x Rapid Charger, 2x 3.0Ah Battery
- Z: Without Charger, Battery & Carrying Case



*Not applicable for Z model



Capacity Kapasiti 能力	Steel: 13mm (1/2") Wood: 38mm (1-1/2") Masonry: 13mm (1/2")
Chuck Capacity Kapasiti Chuck 夹头能力	1.5 - 13mm (1/16 - 1/2")
Impacts Per Minute (IPM) Impak Per Minit 冲击数	High: 0 - 30,000 Low: 0 - 7,500
No Load Speed (RPM) Kelajuan Tanpa Beban 回转数	High: 0 - 2,000 Low: 0 - 2,000
Max Fastening Torque Maksimum Tenaga Pemutaran Pengancing 最快扭力	Hard: 54 N-m (480 in.lbs.) Soft: 30 N-m (270 in.lbs.)
Max Lock Torque Pemutaran Tenaga Maksimum 最大扭力	60N-m (530in.lbs.)
Dimensions (L x W x H) Dimensi 体积	182x79x261mm (7-1/8"x3-1/8"x10-1/4")
Net Weight Berat Bersih 净重	1.6 - 1.9kg (3.5 - 4.2lbs)
Work Amount (approx.) Jumlah Kerja 工作量	1850 pcs with BL1850B Wood Screw ø9 x 25mm

DHP485RFE | **DHP485Z** 13mm (1/2")
 RM 1,795 | RM 820

Cordless Hammer Driver Drill
 Tukul Pemutar Skru Bergerudi Tanpa Kord
 充电式冲击螺丝起子电钻



- All metal gear construction provides increased durability

Standard Equipment: Belt Clip, (+)(-) Bit

- RFE: 1x Rapid Charger, 2x 3.0Ah Battery
- Z: Without Charger, Battery & Carrying Case



*Not applicable for Z model



Capacity Kapasiti 能力	Steel: 13 (1/2") Wood: 38 (1-1/2") Masonry: 13mm (1/2")
Chuck Capacity Kapasiti Chuck 夹头能力	1.5 - 13mm (1/16 - 1/2")
Impacts Per Minute (IPM) Impak Per Minit 冲击数	High: 0 - 28,500 Low: 0 - 7,500
No Load Speed (RPM) Kelajuan Tanpa Beban 回转数	High: 0 - 1900 Low: 0 - 500
Max Fastening Torque Maksimum Tenaga Pemutaran Pengancing 最快扭力	Hard: 50N-m (440in.lbs.) Soft: 27N-m (240in.lbs.)
Max Lock Torque Pemutaran Tenaga Maksimum 最大扭力	50N-m (440in.lbs.)
Dimensions (L x W x H) Dimensi 体积	182x79x255mm (7-1/8"x3-1/8"x10")
Net Weight Berat Bersih 净重	1.5 - 1.8kg (3.2 - 3.9lbs.)
Work Amount (approx.) Jumlah Kerja 工作量	1400 pcs with BL1850B Auger Bit ø15mm (30mm thick Melapi)

* All list price shown are for reference only (exclude SST).

* Semua harga yang ditunjukkan adalah untuk rujukan sahaja (tidak termasuk SST). 所有显示的建议零售价仅供参考 (不包括SST)。

Cordless
Tempat Kerja

LED Flashlight
Lampu Senter LED
PORTABILITY

Vacuum Cleaner
Penyedut Debu

Drilling / Fastening
Gergaji / Pengancing
MIL / 螺絲

Impact Drilling / Demolition
Gergaji / Pencah
MIL / 螺絲

Cutting / Smiting
Gergaji / Pemotong
MIL / 螺絲

Grinding / Smoothing
Gergaji / Pemotong
MIL / 螺絲

Sawing
Gergaji
MIL / 螺絲

Planing / Routing
Gergaji / Pengancing
MIL / 螺絲

Others
MIL / 螺絲

Outdoor Power Equipment
Alatan Kuasa Luar
MIL / 螺絲

Thakita
MIL / 螺絲



Li-ion Ah 6.0 5.0 4.0 3.0 2.0 1.5

DHP459Z 13mm (1/2")
RM 745

Cordless Hammer Driver Drill
Tukul Pemutar Skru Bergerudi Tanpa Kord
充电式冲击螺丝起子电钻



- Brushless motor delivers up to 50% longer run time per charge

Standard Equipment: Belt Clip, (+/-) Bit

- Z: Without Charger & Battery



Capacity Kapasiti 能力	Steel: 13mm (1/2") Wood: 38mm (1-1/2") Masonry: 13mm (1/2")
Chuck Capacity Kapasiti Chuck 夹头能力	1.5 - 13mm (1/16 - 1/2")
Impacts Per Minute (IPM) Impak Per Minit 冲击数	High: 0 - 22,500 Low: 0 - 6,000
No Load Speed (RPM) Kelajuan Tanpa Beban 回转数	High: 0 - 1,500 Low: 0 - 400
Max Fastening Torque Maksimum Tenaga Pemutaran Pengancing 最快扭力	Hard: 45N-m (400in.lbs.) Soft: 25N-m (220in.lbs.)
Max Lock Torque Pemutaran Tenaga Maksimum 最大扭矩	45N-m (400in.lbs.)
Dimensions (L x W x H) Dimensi 体积	192x78x256mm
Net Weight Berat Bersih 净重	1.5 - 1.8kg (3.3 - 4.0lbs)
Work Amount (approx.) Jumlah Kerja 工作量	1470pcs with BL1850B Auger Bit of 5mm (30mm thick Melapi)

DHP453RME DHP453RFE DHP453SYE DHP453Z 13mm (1/2")
RM 1,692 RM 1,527 RM 1,393 RM 552

Cordless Hammer Driver Drill
Tukul Pemutar Skru Bergerudi Tanpa Kord
充电式冲击螺丝起子电钻



- 16 Adjustable torque settings plus drill mode

Standard Equipment: (+/-) Bit

- RME: 1x Rapid Charger, 2x 4.0Ah Battery
- RFE: 1x Rapid Charger, 2x 3.0Ah Battery
- SYE: 1x Standard Charger, 2x 1.5Ah Battery
- Z: Without Charger, Battery & Carrying Case



Capacity Kapasiti 能力	Steel: 13mm (1/2") Wood: 36mm (1-7/16") Masonry: 13mm (1/2")
Impacts Per Minute (IPM) Impak Per Minit 冲击数	High: 0 - 19,500 Low: 0 - 6,000
No Load Speed (RPM) Kelajuan Tanpa Beban 回转数	High: 0 - 1,300 Low: 0 - 400
Max Fastening Torque Maksimum Tenaga Pemutaran Pengancing 最快扭力	Hard: 42N-m Soft: 27N-m
Max Lock Torque Pemutaran Tenaga Maksimum 最大扭矩	38N-m (340in.lbs.)
Dimensions (L x W x H) Dimensi 体积	240x79x244mm (9-7/16"x3-1/8"x9-5/8")
Net Weight Berat Bersih 净重	1.7 - 2.0kg (3.6 - 4.4lbs)
Work Amount (approx.) Jumlah Kerja 工作量	720pcs with BL1850B Wood Screw ø4.1 x 38mm

DHP483RME DHP483RFE DHP483Z 13mm (1/2")
RM 1,957 RM 1,792 RM 817

Cordless Hammer Driver Drill
Tukul Pemutar Skru Bergerudi Tanpa Kord
充电式冲击螺丝起子电钻



- 0-25,500 IPM for fast hammer drilling in masonry materials

Standard Equipment: Belt Clip, (+/-) Bit

- RME: 1x Rapid Charger, 2x 4.0Ah Battery
- RFE: 1x Rapid Charger, 2x 3.0Ah Battery
- Z: Without Charger, Battery & Carrying Case

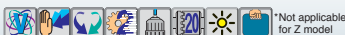

Capacity Kapasiti 能力	Steel: 13mm (1/2") Wood: 36mm (1-7/16") Masonry: 13mm (1/2")
Chuck Capacity Kapasiti Chuck 夹头能力	1.5 - 13mm (1/16 - 1/2")
Impacts Per Minute (IPM) Impak Per Minit 冲击数	High: 0 - 25,500 Low: 0 - 7,500
No Load Speed (RPM) Kelajuan Tanpa Beban 回转数	High: 0 - 1,700 Low: 0 - 500
Max Fastening Torque Maksimum Tenaga Pemutaran Pengancing 最快扭力	Hard: 40N-m (350 in.lbs.) Soft: 23N-m (210 in.lbs.)
Max Lock Torque Pemutaran Tenaga Maksimum 最大扭矩	40N-m (350in.lbs.)
Dimensions (L x W x H) Dimensi 体积	176x79x247mm (6-15/16"x3-1/8"x9-3/4")
Net Weight Berat Bersih 净重	1.3 - 1.6kg (2.8 - 3.6lbs)
Work Amount (approx.) Jumlah Kerja 工作量	200pcs with BL1850B Wood screw ø6 x 75mm

Model No. 型号	Capacity Kapasiti 能力			No Load Speed (rpm) Kelajuan Tanpa Beban 回转数	Impacts Per Minute (IPM) Impak Per Minit 冲击数	Torque Setting Tetapan Pemutaran 扭转设置	Max. Fastening Torque Maksimum Tenaga Pemutaran Pengancing 最快扭力	Overall Length (mm) Panjang Keseluruhan 总长度	Net Weight Berat Bersih 净重	BL MOTOR	XPT
	Steel	Wood	Masonry								
DHP481	13mm	76mm	16mm	0-2,100 / 0-550	High: 0 - 31,500 / Low: 0 - 8,250	21	Hard: 115 / Soft: 60	205	2.7kg (6.0lbs)	●	●
DHP458	13mm	76mm	16mm	0-2,000 / 0-400	High: 0 - 30,000 / Low: 0 - 6,000	21	Hard: 91 / Soft: 58	225	2.2kg (4.9lbs)	●	●
DHP482	13mm	38mm	13mm	0 - 1,900 / 0 - 600	High: 0 - 28,500 / Low: 0 - 9,000	21	Hard: 62 / Soft: 36	198	1.5kg (3.4lbs)	●	●
DHP484	13mm	38mm	13mm	0-2,000 / 0-500	High: 0 - 30,000 / Low: 0 - 7,500	21	Hard: 54 / Soft: 30	182	1.6kg (3.5lbs)	●	●
DHP485	13mm	38mm	13mm	0-1,900 / 0-500	High: 0 - 28,500 / Low: 0 - 7,500	21	Hard: 50 / Soft: 27	182	1.5kg (3.2lbs)	●	●
DHP459	13mm	38mm	13mm	0-1,500 / 0-400	High: 0 - 22,500 / Low: 0 - 6,000	16	Hard: 45 / Soft: 25	192	1.5kg (3.3lbs)	●	●
DHP453	13mm	36mm	13mm	0-1,300 / 0-400	High: 0 - 19,500 / Low: 0 - 6,000	16	Hard: 42 / Soft: 27	240	1.7kg (3.6lbs)	●	●
DHP487	13mm	36mm	13mm	0-1,700 / 0-500	High: 0 - 25,500 / Low: 0 - 7,500	20	Hard: 40 / Soft: 25	164	1.4kg (3.1lbs)	●	●
DHP483	13mm	36mm	13mm	0-1,700 / 0-500	High: 0 - 25,500 / Low: 0 - 7,500	20	Hard: 40 / Soft: 23	176	1.3kg (2.8lbs)	●	●

* All list price shown are for reference only (exclude SST).

* Semua harga yang ditunjukkan adalah untuk rujukan sahaja (tidak termasuk SST). 所有显示的建议零售价仅供参考 (不包括SST)。

Cordless
Target Kuching
LED Flashlight
Lampu Cahaya LED
1500000
Vacuum Cleaner
Penyedut Vakuum
BLUCH
Drilling / Fastening
Druai / Pengait
M10 / M8
Impact Drilling / Demolition
Druai / Demoli
B-2 / B-1
Cutting
Pemotongan
M10
Grinding / Sanding
Pangkas / Pasai
B-1 / B-2
Sawing
Druai
Planing / Routing
Pangkas / Rantai
M10 / M8
Others
Lain-lain
Outdoor Power Equipment
Alatan Kuasa Luar
M10-M8
Makita
1911

BRUSHLESS MOTOR

Motor tanpa berus 无碳刷马达

- Maintenance-free due to no brush
 - Life time work amount of a battery is increased
 - Durable against long continuous operation
 - More work amount on a single full battery charge
- penyenggaraan mudah tanpa proses penggantian berus karbon
 Alat yang menggunakan motor berus BL tidak mengalami geseran haba, dengan itu menjadikan bateri lebih tahan lama
 免却更换碳刷的高频工序, 保养轻松简单
 采用BL无碳刷马达的工具没有因摩擦热导致的能量流失, 所以每次充电后的连续工作时间更长



BL MOTOR
Motor tanpa berus
无碳刷马达

BRUSHED MOTOR

Motor dengan berus 有刷马达

- High power-to-weight ratio obtained by employing 4-pole motor
- Berkuasa tinggi dengan motor 4-pole
 采用4级马达, 高效率

4-POLE MOTOR



Max Fastening Torque

Maksimum Tenaga Pemutaran Pengancing 最大扭矩

180 N·m

175 N·m

170 N·m

165 N·m

155 N·m

140 N·m



A mode [assist mode]

helps to eliminate "screw cam-out" and "cross threading" by driving at low speed until the start of tightening.

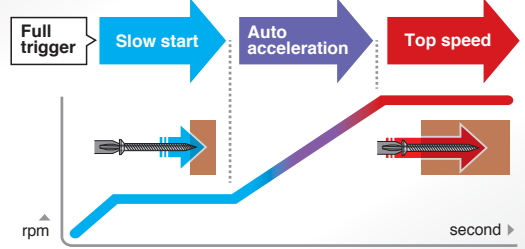

DTD171

Cordless Impact Driver

Pemutar Skru Impak tanpa Kord 充电式冲击螺丝起子机



DTD170

Cordless Impact Driver

Pemutar Skru Impak tanpa Kord 充电式冲击螺丝起子机



DTD154

Cordless Impact Driver

Pemutar Skru Impak tanpa Kord 充电式冲击螺丝起子机



DTD153

Cordless Impact Driver

Pemutar Skru Impak tanpa Kord 充电式冲击螺丝起子机



Ideal for applications such as tightening of self-drilling screws



DTD155 | DTD157

Cordless Impact Driver

Pemutar Skru Impak tanpa Kord 充电式冲击螺丝起子机



DTD149

Cordless Impact Driver

Pemutar Skru Impak tanpa Kord 充电式冲击螺丝起子机



DTD152

Cordless Impact Driver

Pemutar Skru Impak tanpa Kord 充电式冲击螺丝起子机



Ideal for applications such as tightening of self-drilling screws



DTD156

Cordless Impact Driver

Pemutar Skru Impak tanpa Kord 充电式冲击螺丝起子机



DTS141

Cordless Oil-Pulse Driver

Pemutar Skru Impak tanpa Kord 充电式冲击起子机



Suitable for noise sensitive job site

SOFT IMPACT

Low Noise 77dB

40 N·m



DTP141

Cordless 4 Mode Impact Driver

Pemutar Skru Impak tanpa Kord 充电式冲击螺丝起子机



4 Operation modes
Impact driver/
Hammer drill/ Drill/
Screwdriver



150 N·m



"Teks" mode is a special mode optimum for fast tightening of self drilling screws without damaging the screw and the workpiece.

"Teks" mod adalah mod khas yang optimum untuk mengetatkan skru penggerudian sendiri tanpa cepat merosakkan skru dan bahan kerja.

"Teks" 模式是一种特殊模式, 可以在不损坏螺钉和工件的情况下快速拧紧自攻螺钉。

Teks mode

* All list price shown are for reference only (exclude SST).

* Semua harga yang ditunjukkan adalah untuk rujukan sahaja (tidak termasuk SST). 所有显示的建议零售价仅供参考 (不包括SST)。

Cordless
Tempa Kord / 无线

LED Flashlight
Lampu LED
- LED LIGHT

Vacuum Cleaner
Penyedut Debu / 吸尘器

Drilling / Fastening
Galian / Pengancing
- M10 / M12

Impact Drilling / Demolition
Galian / Pecah
- 13.5MM, 16MM, 18MM

Cutting
Pemotong
- 13MM

Grinding / Smoothing
Gilingan / Poles
- 25MM / 30MM

Sawing
Gergaji
- 40MM

Planing / Routing
Pajangan / Tegakan
- 40MM / 45MM

Others
Lain-lain
- 40MM

Outdoor Power Equipment
Alatan Kuasa Luar
- 40MM-75MM

Makita
- 1915



Li-ion Ah 6.0 5.0 4.0 3.0 2.0 1.5

DTD171RTJ RM 2,762 | **DTD171RFJ** RM 2,452 | **DTD171Z** RM 1,477

Cordless Impact Driver
Pemutar Skru Impak Tanpa Kord
充电式冲击螺丝起子机



- Ultra Compact and perfect balance at only 116mm long

Standard Equipment: Belt Clip

- RTJ: 1x Rapid Charger, 2x 5.0Ah Battery, 1x Makpac Connector Box
- RFJ: 1x Rapid Charger, 2x 3.0Ah Battery, 1x Makpac Connector Box
- Z: Without Charger, Battery & Carrying Case

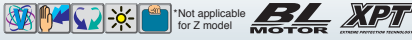

Capacity Kapasiti 能力	Machine Screw: M4 - M8 (5/32" - 5/16") Standard Bolt: M5 - M16 (3/16" - 5/8") High Tensile Bolt: M5 - M14 (3/16" - 9/16") Coarse thread (in length): 22 - 125mm (7/8" - 4-7/8")
Hex Shank Batang Heksagon 六角柄	6.35mm (1/4")
No Load Speed (RPM) Kelajuan Tanpa Beban 回转数	Max/ Hard/ Med/ Soft/ Wood/ Bolt/ T(1)/ T(2) mode: 0 - 3,600/ 3,200/ 2,100/ 1,100/ 1,800/ 3,600/ 2,900/ 3,600
Impacts Per Minute (IPM) Impak Per Minit 冲击数	Max/ Hard/ Med/ Soft/ Wood/ Bolt/ T(1)/ T(2) mode: 0 - 3,800/ 3,600/ 2,600/ 1,100/ 3,800/ 3,800/ N/A/ 2,600
Max Fastening Torque Maksimum Tenaga Pemutaran Pengancing 最快扭力	180N-m (1,590in.lbs.)
Fastening Torque Tenaga Pemutaran Pengancing 扭力	Hard: 170N-m (1,510in.lbs.) Med: 50N-m (440in.lbs.) Soft: 20 N-m (180 in.lbs.)
Dimensions (L x W x H) Dimensi 体积	116x79x236mm (4-9/16"x3-1/8"x9-1/4")
Net Weight Berat Bersih 淨重	1.2 - 1.6kg (2.7 - 3.4lbs.)
Work Amount (approx.) Jumlah Kerja 工作量	808 pcs with BL1850B Coarse thread screw 65mm

DTD170RME RM 2,553 | **DTD170RFE** RM 2,390 | **DTD170Z** RM 1,415

Cordless Impact Driver
Pemutar Skru Impak Tanpa Kord
充电式冲击螺丝起子机



- 6-Mode operation for A-mode/ T-mode/ Max/ Hard/ Medium/ Soft impact mode for multiple applications

Standard Equipment: Belt Clip

- RME: 1x Rapid Charger, 2x 4.0Ah Battery
- RFE: 1x Rapid Charger, 2x 3.0Ah Battery
- Z: Without Charger, Battery & Carrying Case



Capacity Kapasiti 能力	Machine Screw: M4 - M8 (5/32" - 5/16") Standard Bolt: M5 - M16 (3/16" - 5/8") High Tensile Bolt: M5 - M14 (3/16" - 9/16") Coarse Thread (in length): 22 - 125mm (7/8" - 4-7/8")
Hex Shank Batang Heksagon 六角柄	6.35mm (1/4")
No Load Speed (RPM) Kelajuan Tanpa Beban 回转数	Max: 0 - 3,600 Hard: 3,200 Med: 2,100 Soft: 1,100 T Mode: 3,600
Impacts Per Minute (IPM) Impak Per Minit 冲击数	Max: 0 - 3,800 Hard: 3,600 Med: 2,600 Soft: 1,100 T mode: 2,600
Max Fastening Torque Maksimum Tenaga Pemutaran Pengancing 最快扭力	175N-m (1,550in.lbs.)
Dimensions (L x W x H) Dimensi 体积	117x79x236mm (4-5/8"x3-1/8"x9-1/4")
Net Weight Berat Bersih 淨重	1.2 - 1.5kg (2.7 - 3.4lbs)
Work Amount (approx.) Jumlah Kerja 工作量	808 pcs with BL1850B Coarse thread screw 65mm

DTD157RTJ Price TBA | **DTD157RAJ** RM 1,675 | **DTD157Z** RM 773

Cordless Impact Driver
Pemutar Skru Impak Tanpa Kord
充电式冲击螺丝起子机



- 3-mode operation for A-mode / Hard mode / Soft mode for multiple applications

Standard Equipment: Belt Clip,
Double Ended Twist Torsion Screw Bit

- RTJ: 1x Rapid Charger, 2x 5.0Ah Battery, 1x Makpac Connector Box
- RAJ: 1x Rapid Charger, 2x 2.0Ah Battery, 1x Makpac Connector Box
- Z: Without Charger, Battery & Carrying Case

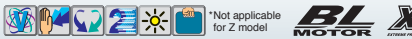

Capacity Keupayaan Pengancing 紧固能力	Machine Screw: M4 - M8mm (5/32 - 5/16") Standard Bolt: M5 - M14 (3/16 - 9/16") High Strength Bolt: M5 - M12 (3/16 - 1/2") Coarse thread (in length): 22 - 90mm (7/8 - 3-1/2")
Hex Shank Skru Persegi 方形螺杆	6.35mm (1/4")
No Load Speed (RPM) Kelajuan Tanpa Beban 回转数	Hard: 0 - 3,000 Soft: 0 - 1,300
Impacts Per Minute (IPM) Impak Per Minit 冲击数	Hard: 0 - 4,100 Soft: 0 - 2,000
Max Fastening Torque Pemutaran Tenaga Maksimum 最大扭矩	140N-m (1,240in.lbs.)
Dimensions (L x W x H) Dimensi 体积	133x81x232mm (5-1/4x3-3/16x9-1/8")
Net Weight Berat Bersih 淨重	1.2 - 1.5kg (2.6 - 3.3lbs.)
Work Amount (approx.) Jumlah Kerja 工作量	1200 pcs with BL1820B Coarse thread screw 90mm into melapi in hard impact mode

DTD154RME RM 2,127 | **DTD154RFE** RM 1,963 | **DTD154Z** RM 988

Cordless Impact Driver
Pemutar Skru Impak Tanpa Kord
充电式冲击螺丝起子机



- Aluminum hammer case creates the impression of rigidity of the machine

Standard Equipment: Belt Clip

- RME: 1x Rapid Charger, 2x 4.0Ah Battery
- RFE: 1x Rapid Charger, 2x 3.0Ah Battery
- Z: Without Charger, Battery & Carrying Case



Capacity Kapasiti 能力	Machine Screw: M4 - M8 (5/32" - 5/16") Standard Bolt: M5 - M16 (3/16" - 5/8") High Tensile Bolt: M5 - M14 (3/16" - 9/16") Coarse Thread (in length): 22 - 125mm (7/8" - 4-7/8")
Hex Shank Batang Heksagon 六角柄	6.35mm (1/4")
No Load Speed (RPM) Kelajuan Tanpa Beban 回转数	0 - 3,600 0 - 2,100 0 - 1,100
Impacts Per Minute (IPM) Impak Per Minit 冲击数	0 - 3,800 0 - 2,600 0 - 1,100
Max Fastening Torque Maksimum Tenaga Pemutaran Pengancing 最快扭力	175N-m (1,550in.lbs.)
Dimensions (L x W x H) Dimensi 体积	117x79x236mm (4-5/8"x3-1/8"x9-1/4")
Net Weight Berat Bersih 淨重	1.3 - 1.6kg (2.7 - 3.4lbs)
Work Amount (approx.) Jumlah Kerja 工作量	800 pcs with BL1850B Wood screw 64.3 x 65mm

DTD153RTE RM 2,102 | **DTD153RFE** RM 1,792 | **DTD153Z** RM 817

Cordless Impact Driver
Pemutar Skru Impak Tanpa Kord
充电式冲击螺丝起子机



- Aluminum hammer case creates the impression of rigidity of the machine

Standard Equipment: Belt Clip

- RTE: 1x Rapid Charger, 2x 5.0Ah Battery
- RFE: 1x Rapid Charger, 2x 3.0Ah Battery
- Z: Without Charger, Battery & Carrying Case



Capacity Kapasiti 能力	Machine Screw: M4 - M8 (5/32" - 5/16") Standard Bolt: M5 - M16 (3/16" - 5/8") High Tensile Bolt: M5 - M14 (3/16" - 9/16") Coarse Thread (in length): 22 - 125mm (7/8" - 4-7/8")
Hex Shank Batang Heksagon 六角柄	6.35mm (1/4")
No Load Speed (RPM) Kelajuan Tanpa Beban 回转数	0 - 3,400
Impacts Per Minute (IPM) Impak Per Minit 冲击数	0 - 3,600
Max Fastening Torque Maksimum Tenaga Pemutaran Pengancing 最快扭力	170N-m (1,500in.lbs.)
Dimensions (L x W x H) Dimensi 体积	126x79x238mm (5"x3-1/8"x9-3/8")
Net Weight Berat Bersih 淨重	1.3 - 1.6kg (2.8 - 3.5lbs)
Work Amount (approx.) Jumlah Kerja 工作量	760 pcs with BL1850B Wood screw 65mm

* All list price shown are for reference only (exclude SST).

* Semua harga yang ditunjukkan adalah untuk rujukan sahaja (tidak termasuk SST). 所有显示的建议零售价仅供参考 (不包括SST)。

Cordless Impact Driver
LED Flashlight
Vacuum Cleaner
Drilling / Fastening
Impact Drilling / Demolition
Cutting
Grinding / Sanding
Sawing
Planing / Routing
Drivers





Li-ion Ah 6.0 5.0 4.0 3.0 2.0 1.5

DTD149RFE | DTD149Z
RM 1,737 | RM 762

448

Cordless Impact Driver
Pemutar Skru Impak Tanpa Kord
充电式冲击螺丝起子机



- Developed for main applications such as tightening of self-drilling screws or light duty machine screws

Standard Equipment: Belt Clip

- RFE: 1x Rapid Charger, 2x 3.0Ah Battery
- Z: Without Charger, Battery & Carrying Case



Capacity Kapasiti 能力	Machine Screw: M4 - M8 (5/32" - 5/16") Standard Bolt: M5 - M14 (3/16" - 9/16") High Tensile Bolt: M5 - M12 (3/16" - 1/2") Coarse Thread (in length): 22 - 125mm (7/8" - 4-7/8") 6.35mm (1/4")
Hex Shank Batang Heksagon 六角柄	
No Load Speed (RPM) Kelajuan Tanpa Beban 回转数	0 - 2,500
Impacts Per Minute (IPM) Impak Per Minit 冲击数	0 - 3,200
Max Fastening Torque Maksimum Tenaga Pemutaran Pengancing 最快扭力	165N-m (1,460in.lbs.)
Dimensions (L x W x H) Dimensi 体积	135x79x238mm (5-5/16"x3-1/8"x9-3/8")
Net Weight Berat Bersih 淨重	1.3 - 1.6kg (2.8 - 3.5lbs)
Work Amount (approx.) Jumlah Kerja 工作量	533 pcs with BL1850B Wood screw ø4.3 x 65mm

DTD152RME | DTD152RFE | DTD152Z
RM 1,902 | RM 1,737 | RM 762

448

Cordless Impact Driver
Pemutar Skru Impak Tanpa Kord
充电式冲击螺丝起子机



- Aluminum hammer case creates the impression of rigidity of the machine

Standard Equipment: Belt Clip

- RME: 1x Rapid Charger, 2x 4.0Ah Battery
- RFE: 1x Rapid Charger, 2x 3.0Ah Battery
- Z: Without Charger, Battery & Carrying Case



Capacity Kapasiti 能力	Machine Screw: M4 - M8 (5/32" - 5/16") Standard Bolt: M5 - M16 (3/16" - 5/8") High Tensile Bolt: M5 - M12 (3/16" - 1/2") Coarse Thread (in length): 22 - 125mm (7/8" - 4-7/8") 6.35mm (1/4")
Hex Shank Batang Heksagon 六角柄	
No Load Speed (RPM) Kelajuan Tanpa Beban 回转数	0 - 2,900
Impacts Per Minute (IPM) Impak Per Minit 冲击数	0 - 3,500
Max Fastening Torque Maksimum Tenaga Pemutaran Pengancing 最快扭力	165N-m (1,460 in.lbs.)
Dimensions (L x W x H) Dimensi 体积	137x79x238mm (5-3/8"x3-1/8"x9-3/8")
Net Weight Berat Bersih 淨重	1.3 - 1.6kg (2.8 - 3.5lbs)
Work Amount (approx.) Jumlah Kerja 工作量	603 pcs with BL1850B Hex screw 3/4" (Holding sheet 0.23mm RHS 1.6mm)

DTD156SF | DTD156Z
RM 988 | RM 340

5

Cordless Impact Driver
Pemutar Skru Impak Tanpa Kord
充电式冲击螺丝起子机



- Compact, lightweight but powerful 4-pole motor

Standard Equipment: Belt Clip

- SF: 1x Standard Charger, 1x 3.0Ah Battery
- Z: Without Charger, Battery & Carrying Case



Capacity Kapasiti 能力	Machine Screw: M4 - M8 (5/32" - 5/16") Standard Bolt: M5 - M14 (3/16" - 9/16") High Strength Bolt: M5 - M12 (3/16" - 1/2") Coarse Thread (in length): 22 - 125mm (7/8" - 4-7/8")
Hex Shank Batang Heksagon 六角柄	6.35mm (1/4")
No Load Speed (RPM) Kelajuan Tanpa Beban 回转数	0 - 2,500
Impacts Per Minute (IPM) Impak Per Minit 冲击数	0 - 3,000
Max Fastening Torque Maksimum Tenaga Pemutaran Pengancing 最快扭力	155N-m (1,370in.lbs.)
Dimensions (L x W x H) Dimensi 体积	143x79x241mm (5-5/8"x3-1/8"x9-1/2")
Net Weight Berat Bersih 淨重	1.3 - 1.6kg (2.9 - 3.6lbs.)
Work Amount (approx.) Jumlah Kerja 工作量	340 pcs with BL1830B Coarse thread screw 90mm into melapi

DTD155RME | DTD155Z
RM 1,912 | RM 773

Cordless Impact Driver
Pemutar Skru Impak Tanpa Kord
充电式冲击螺丝起子机



- 3-Mode operation for A-mode / Hard mode / Soft mode for multiple applications

Standard Equipment: Belt Clip

- RME: 1x Rapid Charger, 2x 4.0Ah Battery
- Z: Without Charger, Battery & Carrying Case

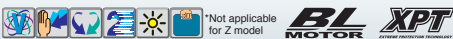

Capacity Kapasiti 能力	Machine Screw: M4 - M8 mm (5/32" - 5/16") Standard Bolt: M5 - M14 (3/16" - 9/16") High Tensile Bolt: M5 - M12 (3/16" - 1/2") Coarse Thread (in length): 22 - 90mm (7/8" - 3-1/2") 6.35mm (1/4")
Hex Shank Batang Heksagon 六角柄	
No Load Speed (RPM) Kelajuan Tanpa Beban 回转数	Hard: 0 - 3,000 Soft: 0 - 1,300
Impacts Per Minute (IPM) Impak Per Minit 冲击数	Hard: 0 - 3,900 Soft: 0 - 1,600
Max Fastening Torque Maksimum Tenaga Pemutaran Pengancing 最快扭力	140N-m (1,240in.lbs.)
Dimensions (L x W x H) Dimensi 体积	135x79x232mm (5-5/16"x3-1/8"x9-1/8")
Net Weight Berat Bersih 淨重	1.2 - 1.5kg (2.6 - 3.2lbs)
Work Amount (approx.) Jumlah Kerja 工作量	725 pcs with BL1850B Coarse thread screw 65mm (melapi)

DTP141RFE | DTP141Z
RM 2,845 | RM 1,868

Cordless 4 Mode Impact Driver
Pemutar Skru Impak Tanpa Kord
充电式冲击螺丝起子机



- 4 Operation Modes (Impact Driver, Hammer Drill, Drill, Screwdriver) and Teks Screw Mode selection

Standard Equipment: Belt Clip

- RFE: 1x Rapid Charger, 2x 3.0Ah Battery
- Z: Without Charger, Battery & Carrying Case



Capacity Kapasiti 能力	Steel: 10mm (3/8") / Wood: 21mm (13/16") Masonry: 8mm (5/16")
No Load Speed (RPM) Kelajuan Tanpa Beban 回转数	Impact-driver Mode: Hard: 0 - 2,700 Medium: 0 - 2,200 Soft: 0 - 1,300 Drill Mode High: 0 - 2,700 Low: 0 - 700 Hammer Drill Mode High: 0 - 2,700 Low: 0 - 700 Screwdriver Mode High: 0 - 1,100 Low: 0 - 300
Impacts Per Minute (IPM) Impak Per Minit 冲击数	Impact-driver Mode (Hard: 0-3,200 Medium: 0-2,400 Soft: 0-1,200) Hammer Drill Mode (Hi: 0 - 32,400 Lo: 0 - 8,400)
Max Fastening Torque Maksimum Tenaga Pemutaran Pengancing 最快扭力	Impact-driver Mode: 150N-m (1,330in.lbs.) Drill Mode (Hard/ Soft): 22/ 13N-m
Dimensions (L x W x H) Dimensi 体积	171x79x250mm (6-3/4"x3-1/8"x9-7/8")
Net Weight Berat Bersih 淨重	1.5 - 1.9kg (3.4 - 4.1lbs)

* All list price shown are for reference only (exclude SST).

* Semua harga yang ditunjukkan adalah untuk rujukan sahaja (tidak termasuk SST). 所有显示的建议零售价仅供参考 (不包括SST)。

Cordless
Tempat Kerja
LED Flashlight
Vacuum Cleaner
Drilling / Fastening
Impact Drilling / Demolition
Cutting / Slicing
Grinding / Sanding
Sawing
Planing / Routing
Others
Outdoor Power Equipment





Li-ion Ah 6.0 5.0 4.0 3.0 2.0 1.5

DTS141RFE | **DTS141Z**
RM 3,183 | RM 2,207

Cordless Oil-Pulse Driver
Pemutar Skru Impak Tanpa Kord
充电式冲击起子机



- Low noise level of 77dB



Standard Equipment: Belt Clip
• RFE: 1x Rapid Charger, 2x 3.0Ah Battery
• Z: Without Charger, Battery & Carrying Case



*Not applicable for Z model



Capacity Kapasiti 能力	Machine Screw: M4 - M8 (5/32" - 5/16") Standard Bolt: M5 - M8 (3/16" - 5/16") High Tensile Bolt: M5 - M6 (3/16" - 1/4") Coarse Thread (in length): 22 - 125mm (7/8" - 4-7/8")
No Load Speed (RPM) Kelajuan Tanpa Beban 回转数	Hard: 0-3,200 Medium: 0-2,000 Soft: 0-1,200
Impacts Per Minute (IPM) Impak Per Minit 冲击数	Hard: 0-2,700 Medium: 0-2,200 Soft: 0-1,400
Max Fastening Torque Maksimum Tenaga Pemutaran Pengancing 最快扭力	40N-m (355in.lbs.)
Dimensions (L x W x H) Dimensi 体积	136x79x240mm (5-3/8"x3-1/8"x9-1/2")
Net Weight Berat Bersih 净重	1.3 - 1.6kg (2.8 - 3.5lbs)
Work Amount (approx.) Jumlah Kerja 工作量	750 pcs with BL1850B Wood screw ø4.3 x 65mm

Model No. 型号	No Load Speed (rpm) Kelajuan Tanpa Beban 回转数	Impacts Per Minute (IPM) Impak Per Minit 冲击数	Electronic Speed Kelajuan Elektronik 电子速度	Max. Fastening Torque (N.m) Maksimum Tenaga Pemutaran Pengancing 最快扭转	Overall Length (mm) Panjang Keseluruhan 总长度	Net Weight Berat Bersih 净重	BL MOTOR	XPT
Cordless Impact Driver								
DTD171	0 - 3,600 / 3,200 / 2,100 / 1,100 / 1,800 / 3,600 / 2,900 / 3,600	0 - 3,800 / 3,600 / 2,600 / 1,100 / 3,800 / 3,800 / N/A / 2,600	4	180	116	1.2kg (2.7lbs)	●	●
DTD170	0 - 3,600 / 3,200 / 2,100 / 1,100 / 3,600	0 - 3,800 / 3,600 / 2,600 / 1,100 / 2,600	4	175	117	1.2kg (2.7lbs)	●	●
DTD154	0 - 3,600 / 0 - 2,100 / 0 - 1,100	0 - 3,800 / 0 - 2,600 / 0 - 1,100	3	175	117	1.3kg (2.7lbs)	●	●
DTD153	0 - 3,400	0 - 3,600	-	170	126	1.3kg (2.8lbs)	●	●
DTD149	0 - 2,500	0 - 3,200	-	165	135	1.3 kg (2.8lbs)	●	●
DTD152	0 - 2,900	0 - 3,500	-	165	137	1.3kg (2.8lbs)	●	●
DTD156	0 - 2,500	0 - 3,000	-	155	143	1.3kg (2.9lbs)	●	●
DTD157	0 - 3,000 / 0 - 1,300	0 - 4,100 / 0 - 2,000	2	140	133	1.2kg (2.6lbs)	●	●
DTD155	0 - 3,000 / 0 - 1,300	0 - 3,900 / 0 - 1,600	2	140	135	1.2kg (2.6lbs)	●	●
Cordless 4 Mode Impact Driver (Impact-driver mode)								
DTP141	0-2,700 / 0-2,200 / 0-1,300	0-3,200 / 0-2,400 / 0-1,200	3	150	171	1.5kg (3.4lbs)	●	●
Cordless Oil-Pulse Drive								
DTS141	0-3,200 / 0-2,000 / 0-1,200	0-2,700 / 0-2,200 / 0-1,400	3	40	136	1.3kg (2.8lbs)	●	●

DTL061Z
RM 1,127

Cordless Angle Impact Driver
Pemutar Skru Impak Sudut
Tanpa Kord
充电式角向冲击螺丝起子机



- 360 degrees rotatable head enables operation from optimum angle



Standard Equipment: Belt Clip

- Z: Without Charger & Battery



Capacity Kapasiti 能力	Machine Screw: M4 - M8 (5/32" - 5/16") Standard Bolt: M4 - M12 (5/32" - 1/2") High Tensile Bolt: M4 - M8 (5/32" - 5/16") Coarse Thread (in length): 22 - 75mm (7/8" - 2-31/32") 6.35mm (1/4")
Hex Shank Batang Heksagon 六角柄	
No Load Speed (RPM) Kelajuan Tanpa Beban 回转数	0 - 2,000
Impacts Per Minute (IPM) Impak Per Minit 冲击数	0 - 3,000
Max Fastening Torque Maksimum Tenaga Pemutaran Pengancing 最快扭力	60N-m (530in.lbs.)
Dimensions (L x W x H) Dimensi 体积	387x78x116mm (15-1/4"x3-1/16"x4-9/16")
Net Weight Berat Bersih 净重	1.4 - 2.0kg (3.1 - 4.3lbs)
Work Amount (approx.) Jumlah Kerja 工作量	350 pcs with BL1850B Wood Screw 4.2 x 65mm

DDA450Z
Price TBA

Cordless Angle Drill
Gerudi Sudut Tanpa Kord
充电式角向电钻



- Compact and lightweight for increased maneuverability in various work postures and reduced user fatigue



Standard Equipment:
Chuck Key, Chuck Key Holder,
Side Grip, Hook, + Screw

- Z: Without Charger & Battery



Capacity Kapasiti 能力	Steel: 13mm (1/2") Wood (Auger-Bit): 38mm (1-1/2") Wood (Hole Saw) Hi: 101mm (4") Wood (Hole Saw) Lo: 127mm (5") Wood (Self-Feed Bit) Hi: 50mm (2") Wood (Self-Feed Bit) Lo: 65mm (2-9/16")
Chuck Capacity Kapasiti Chuck 夹头能力	2 - 13mm (1/16 - 1/2")
No Load Speed (RPM) Kelajuan Tanpa Beban 回转数	High: 0 - 1,400 Low: 0 - 450
Max Fastening Torque Pemutaran Tenaga Maksimum 最大扭矩	High: 26N-m (230in.lbs.) Low: 70N-m (620in.lbs.)
Dimensions (L x W x H) Dimensi 体积	434x82x179mm (17-1/8x3-1/4x7")
Net Weight Berat Bersih 净重	3.2 - 3.5kg (7.1 - 7.7lbs.)

DDA351Z 10mm (3/8")
RM 1,108

Cordless Angle Drill
Gerudi Sudut Tanpa Kord
充电式角向电钻



- Original 4-pole motor for power, lightweight and compact size



Standard Equipment: Side Grip

- Z: Without Charger & Battery



Capacity Kapasiti 能力	Steel: 10mm (3/8") Wood: 25mm (1")
No Load Speed (RPM) Kelajuan Tanpa Beban 回转数	0-1,800
Dimensions (L x W x H) Dimensi 体积	326x79x115mm (12-7/8"x3-1/8"x4-1/2")
Net weight Berat Bersih 净重	1.6 - 1.9kg (4.2 - 3.5lbs)
Work Amount (approx.) Jumlah Kerja 工作量	1000 pcs with BL1850B Wood Screw ø5.1 x 38mm

* All list price shown are for reference only (exclude SST).

* Semua harga yang ditunjukkan adalah untuk rujukan sahaja (tidak termasuk SST). 所有显示的建议零售价仅供参考 (不包括SST)。

18V

LXT

Li-ion Ah 6.0 5.0 4.0 3.0 2.0 1.5

DFS452Z

RM 1,427

Cordless ScrewdriverPemutar Skru Tanpa Kord
充电式螺丝起子机

- Push Drive Technology for Quieter Operation; Minimizes Power Consumption

Standard Equipment: Phillips Bit, Magnetic Bit Holder, Belt Clip

- Z: Without Charger & Battery

**DFS250RTE**

RM 2,553

DFS250RFE

RM 2,243

DFS250Z

RM 1,270

Cordless ScrewdriverPemutar Skru Tanpa Kord
充电式螺丝起子机

- Ultra-high efficiency comparable to AC screwdrivers

Standard Equipment: Phillips Bit, Magnetic Bit Holder, Belt Clip

- RTE: 1x Rapid Charger, 2x 5.0Ah Battery
- RFE: 1x Rapid Charger, 2x 3.0Ah Battery
- Z: Without Charger, Battery & Carrying Case

**DFS251RTE**

RM 2,553

DFS251RFE

RM 2,243

DFS251Z

RM 1,270

Cordless ScrewdriverPemutar Skru Tanpa Kord
充电式螺丝起子机

- High torque ideal for fastening self-drilling screw

Standard Equipment: Magnetic Socket Bit, Belt Clip

- RTE: 1x Rapid Charger, 2x 5.0Ah Battery
- RFE: 1x Rapid Charger, 2x 3.0Ah Battery
- Z: Without Charger, Battery & Carrying Case

**DFR550Z**

RM 1,452

440 mm

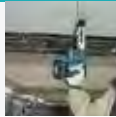
Cordless Auto Feed ScrewdriverPemutar Skru Suapan Auto Tanpa Kord
充电式自动螺丝起子机

- Ideal for drywall and subfloors

Standard Equipment: Phillips Bit x3

- Z: Without Charger & Battery



Capacity Kapasiti 能力	Self-Drilling Screw: 6mm (1/4") Drywall Screw: 5mm (3/16") 6.35mm (1/4")
Driving Shank (Hex) Hex Memandu Aci 六角驱动轴	
No Load Speed (RPM) Kelajuan Tanpa Beban 回转数	0 - 4,000
Dimensions (L x W x H) Dimensi 体积	251x79x259mm (10"x3-1/8"x11-1/4")
Net weight Berat Bersih 淨重	1.5 - 1.8kg (3.2 - 3.9lbs)
Work Amount (approx.) Jumlah Kerja 工作量	2325 pcs with BL1850B Wood Screw 1.0 x 32mm

Capacity Kapasiti 能力	Coarse Thread: 4.5 x 90mm (3/16" x 3-1/2") Self-Drilling Screw: 6mm (1/4") Drywall Screw: 5mm (3/16") 6.35mm (1/4")
Driving Shank (Hex) Hex Memandu Aci 六角驱动轴	
No Load Speed (RPM) Kelajuan Tanpa Beban 回转数	0 - 2,500
Dimensions (L x W x H) Dimensi 体积	259x79x259mm (10-1/4"x3-1/8"x10-1/4")
Net weight Berat Bersih 淨重	1.5 - 1.9kg (3.4 - 4.1lbs)
Work Amount (approx.) Jumlah Kerja 工作量	1091 pcs with BL1850B Wood Screw 8" x 1" (Pine Wood)

Capacity Kapasiti 能力	Self-Drilling Screw: 6mm (1/4") Drywall Screw: 5mm (3/16") Hex Socket Screw: 6mm (1/4")
Driving Shank (Hex) Hex Memandu Aci 六角驱动轴	6.35mm (1/4")
No Load Speed (RPM) Kelajuan Tanpa Beban 回转数	0 - 2,500
Dimensions (L x W x H) Dimensi 体积	237x79x259mm (9-3/8"x3-1/8"x11-1/4")
Net weight Berat Bersih 淨重	1.5 - 1.8kg (3.2 - 3.9lbs)
Work Amount (approx.) Jumlah Kerja 工作量	1091 pcs with BL1850B Wood Screw 8" x 1" (Pine Wood)

Screw Strip Kapasiti 能力	4 x 25 - 55mm (5/32" x 1" - 2-3/16")
Driving Shank (Hex) Hex Memandu Aci 六角驱动轴	6.35mm (1/4")
No Load Speed (RPM) Kelajuan Tanpa Beban 回转数	4,000
Dimensions (L x W x H) Dimensi 体积	424x80x238mm (16-3/4"x3-1/8"x9-3/8")
Net weight Berat Bersih 淨重	2.1 - 3.1kg (4.6 - 6.9lbs)
Work Amount (approx.) Jumlah Kerja 工作量	1166 pcs with BL1850B Wood Screw 35mm (1-3/8") (plasterboard into Douglas-fir timber)

* All list price shown are for reference only (exclude SST).

* Semua harga yang ditunjukkan adalah untuk rujukan sahaja (tidak termasuk SST). 所有显示的建议零售价仅供参考 (不包括SST)。

Cordless
Tempat KerjaLED Flashlight
Lampu Sinar LED
- LED LIGHTVacuum Cleaner
Penyedut Hava
- VACUUMDrilling / Fastening
Galian / Pasang
- DRILLINGImpact Drilling / Demolition
Galian / Pecah
- IMPACTCutting
Memotong
- CUTTINGGrinding / Sanding
Mengekil / Mengkil
- GRINDINGSawing
Gergaji
- SAWINGPlaning / Routing
Pijuan / Trogam
- PLANINGOthers
Lain-lain
- OTHERSOutdoor Power Equipment
Alatan Kuat Daya
- OPEEMakita
- MAKITA

BRUSHLESS MOTOR

Motor tanpa berus 无碳刷马达

- Maintenance-free due to no brush
 - Life time work amount of a battery is increased
 - Durable against long continuous operation
 - More work amount on a single full battery charge
- penyenggaraan mudah tanpa proses penggantian berus karbon
 Alat yang menggunakan motor berus BL tidak mengalami geseran haba, dengan itu menjadikan bateri lebih tahan lama
 免却更换碳刷的麻烦工序, 保养较简单
 采用BL无碳刷马达的工具没有因摩擦热导致的能量流失, 所以每次充电后的连续工作时间更长



BRUSHED MOTOR

Motor dengan berus 有刷马达

- High power-to-weight ratio obtained by employing 4-pole motor
- Berkuasa tinggi dengan motor 4-pole
 采用4极马达, 高功率



4-POLE MOTOR

2-POLE MOTOR

Max Fastening Torque

Maksimum Tenaga Pemutaran Pengancing 最大扭矩

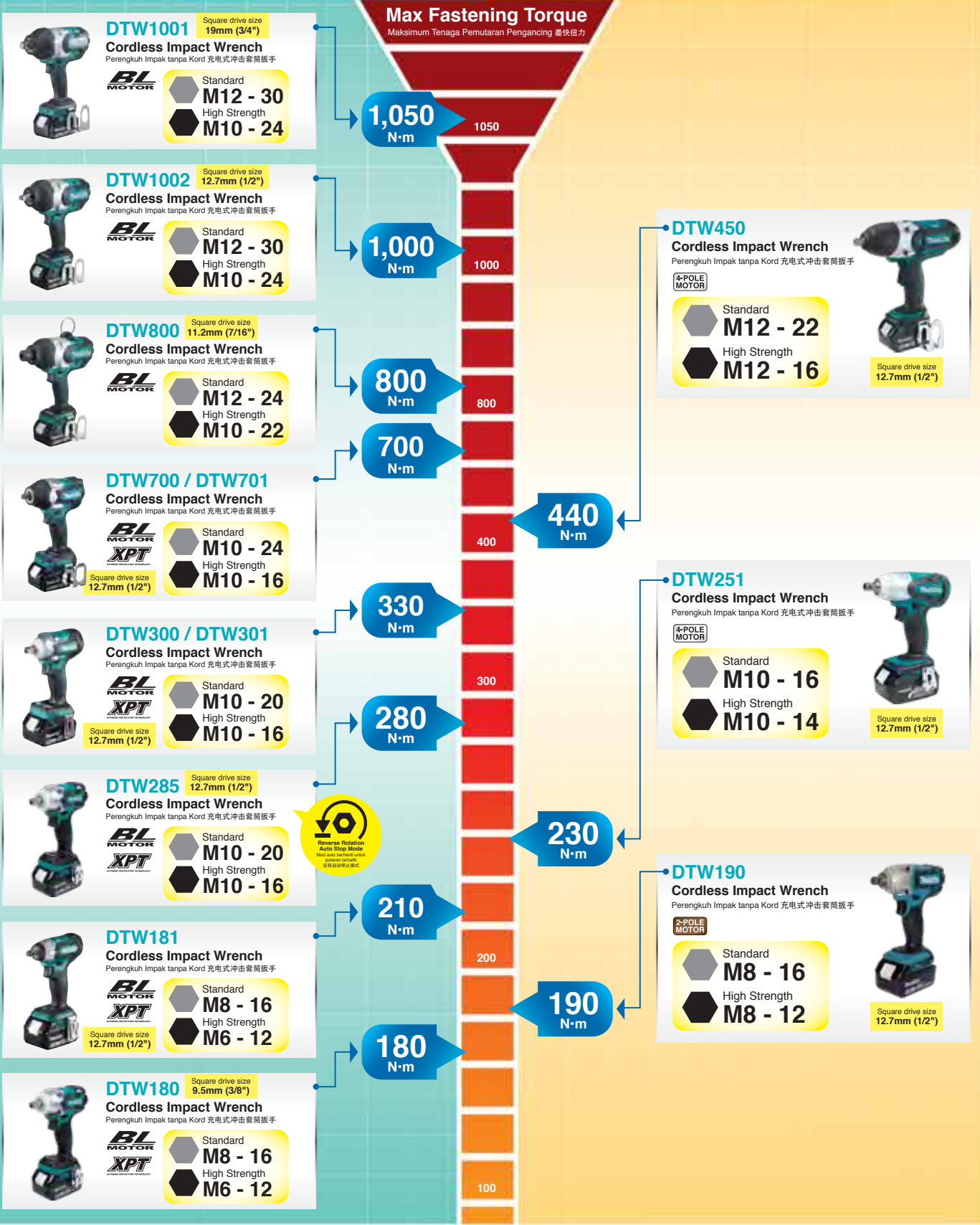

* All list price shown are for reference only (exclude SST).

* Semua harga yang ditunjukkan adalah untuk rujukan sahaja (tidak termasuk SST). 所有显示的建议零售价仅供参考 (不包括SST)。

Cordless Impact Wrench
 LED Flashlight Lampu Cahaya LED
 Vacuum Cleaner Pembersih Vakuum
 Drilling / Fastening
 Impact Drilling / Demolition
 Cutting / Penapisan
 Grinding / Sanding
 Sawing / Gergaji
 Planing / Routing
 Others / Lain-lain
 Outdoor Power Equipment
 Makita



Li-ion Ah 6.0 5.0 4.0 3.0 2.0 1.5

DTW1001RTJ RM 3,542	DTW1001RMJ RM 3,397	DTW1001RFJ RM 3,232	DTW1001Z 19mm (3/4") RM 2,257
-------------------------------	-------------------------------	-------------------------------	---

Cordless Impact Wrench
Perengkuh Impak Tanpa Kord
充电式冲击套筒扳手



• Makita's Most Powerful Impact Wrench

Standard Equipment: Hook

• RTJ: 1x Rapid Charger, 2x 5.0Ah Battery, 1x Makpac Connector Box
• RMJ: 1x Rapid Charger, 2x 4.0Ah Battery, 1x Makpac Connector Box
• RFJ: 1x Rapid Charger, 2x 3.0Ah Battery, 1x Makpac Connector Box
• Z: Without Charger, Battery & Carrying Case

QR Code: DTW1001

VIDEO CLIP
Models and specs may vary by country

Not applicable for Z model

Fastening Capacities Kapasti 能力	Standard Bolt: M12 - M30 (1/2" - 1-1/4") High Tensile Bolt: M10 - M24 (3/8" - 1") 19mm (3/4")
Square Drive Skrü Persegi 方形螺柱	
No Load Speed (RPM) Kelajuan Tanpa Beban 回转速数	Hard: 0 - 1,800 Medium: 0 - 1,000 Soft: 0 - 900
Impacts Per Minute (IPM) Impak Per Minit 冲击数	Hard: 0 - 2,200 Medium: 0 - 2,000 Soft: 0 - 1,800
Max Fastening Torque Pemutaran Tenaga Maksimum 最大扭矩	1,050N-m (780ft.lbs.)
Dimensions (L x W x H) Dimensi 体积	229x91x289mm (9"x3-5/8"x11-3/8")
Net Weight Berat Bersih 淨重	3.4 - 3.7kg (7.5 - 8.2lbs)
Work Amount (approx.) Jumlah Kerja 工作量	185 pcs with BL1850B Bolts M20

DTW1002RTJ RM 3,457	DTW1002RMJ RM 3,312	DTW1002RFJ RM 3,147	DTW1002Z 12.7mm (1/2") RM 2,172
-------------------------------	-------------------------------	-------------------------------	---

Cordless Impact Wrench
Perengkuh Impak Tanpa Kord
充电式冲击套筒扳手



• Efficient impact system (Max 2,200 IPM) with less vibration

Standard Equipment: Hook

• RTJ: 1x Rapid Charger, 2x 5.0Ah Battery, 1x Makpac Connector Box
• RMJ: 1x Rapid Charger, 2x 4.0Ah Battery, 1x Makpac Connector Box
• RFJ: 1x Rapid Charger, 2x 3.0Ah Battery, 1x Makpac Connector Box
• Z: Without Charger, Battery & Carrying Case

Not applicable for Z model

Fastening Capacities Kapasti 能力	Standard Bolt: M12 - M30 (1/2" - 1-1/4") High Tensile Bolt: M10 - M24 (3/8" - 1") 12.7mm (1/2")
Square Drive Skrü Persegi 方形螺柱	
No Load Speed (RPM) Kelajuan Tanpa Beban 回转速数	Hard: 0 - 1,800 Medium: 0 - 1,000 Soft: 0 - 900
Impacts Per Minute (IPM) Impak Per Minit 冲击数	Hard: 0 - 2,200 Medium: 0 - 2,000 Soft: 0 - 1,800
Max Fastening Torque Pemutaran Tenaga Maksimum 最大扭矩	1,000N-m (740ft.lbs.)
Dimensions (L x W x H) Dimensi 体积	229x91x289mm (9"x3-5/8"x11-3/8")
Net Weight Berat Bersih 淨重	3.3 - 3.6kg (7.3 - 8.0lbs)
Work Amount (approx.) Jumlah Kerja 工作量	185 pcs with BL1850B Bolts M20

DTW800RMJ RM 3,338	DTW800RFJ RM 3,173	DTW800Z 11.2mm (7/16") RM 2,198
------------------------------	------------------------------	---

Cordless Impact Wrench
Perengkuh Impak Tanpa Kord
充电式冲击套筒扳手



• Extremely high power 800N-m (590ft.lbs.) way ahead of competitors

Standard Equipment: Hook

• RMJ: 1x Rapid Charger, 2x 4.0Ah Battery, 1x Makpac Connector Box
• RFJ: 1x Rapid Charger, 2x 3.0Ah Battery, 1x Makpac Connector Box
• Z: Without Charger, Battery & Carrying Case

Not applicable for Z model

Fastening Capacities Kapasti 能力	Standard Bolt: M12 - M24 (1/2" - 1") High Tensile Bolt: M10 - M22 (3/8" - 7/8") 11.1mm (7/16")
Hex Shank Skrü Persegi 方形螺柱	
No Load Speed (RPM) Kelajuan Tanpa Beban 回转速数	Hard: 0 - 1,800 Medium: 0 - 1,000 Soft: 0 - 900
Impacts Per Minute (IPM) Impak Per Minit 冲击数	Hard: 0 - 2,200 Medium: 0 - 2,000 Soft: 0 - 1,800
Max Fastening Torque Pemutaran Tenaga Maksimum 最大扭矩	800N-m (590ft.lbs.)
Dimensions (L x W x H) Dimensi 体积	229x91x303mm (9"x3-5/8"x11-7/8")
Net Weight Berat Bersih 淨重	3.4 - 3.7kg (8.2 - 7.5lbs)
Work Amount (approx.) Jumlah Kerja 工作量	27 holes with BL1850B Auger Drill ø13/16" (Drill 300mm Douglas-fir)

DTW700RTJ RM 3,072	DTW700Z 12.7mm (1/2") RM 1,787
------------------------------	--

Cordless Impact Wrench
Perengkuh Impak Tanpa Kord
充电式冲击套筒扳手



• 3 modes of reaction time for automatic stop available both in forward and reverse rotation modes

Standard Equipment: Hook

• RTJ: 1x Rapid Charger, 2x 5.0Ah Battery, 1x Makpac Connector Box
• Z: Without Charger, Battery & Carrying Case

Not applicable for Z model

Fastening Capacities Keupayaan Pengancing 紧固能力	Standard Bolt: M10 - M24 (3/8" - 1") High Strength Bolt (Grade 10.9): M10 - M16 (3/8" - 5/8") High Strength Bolt (Grade F10T): M12, M16 (7/16, 5/8")
Square Drive Skrü Persegi 方形螺柱	12.7mm (1/2")
No Load Speed (RPM) Kelajuan Tanpa Beban 回转速数	Max: 0 - 2,200 Hard: 1,900 Medium: 1,200 Soft: 500
Impacts Per Minute (IPM) Impak Per Minit 冲击数	Max: 0 - 2,700 Hard: 2,400 Medium: 1,700 Soft: 1,000
Max Fastening Torque Pemutaran Tenaga Maksimum 最大扭矩	700N-m (520ft.lbs.)
Dimensions (L x W x H) Dimensi 体积	170x81x276mm (6-11/16x3-3/16x10-7/8")
Net Weight Berat Bersih 淨重	2.3 - 2.7kg (5.1 - 6.0lbs.)

DTW701RTJ RM 3,072	DTW701Z 12.7mm (1/2") RM 1,787
------------------------------	--

Cordless Impact Wrench
Perengkuh Impak Tanpa Kord
充电式冲击套筒扳手



• 3 modes of reaction time for automatic stop available both in forward and reverse rotation modes

Standard Equipment: Hook

• RTJ: 1x Rapid Charger, 2x 5.0Ah Battery, 1x Makpac Connector Box
• Z: Without Charger, Battery & Carrying Case

Not applicable for Z model

Fastening Capacities Keupayaan Pengancing 紧固能力	Standard Bolt: M10 - M24 (3/8" - 1") High Strength Bolt (Grade 10.9): M10 - M16 (3/8" - 5/8") High Strength Bolt (Grade F10T): M12, M16 (7/16, 5/8")
Square Drive Skrü Persegi 方形螺柱	12.7mm (1/2")
No Load Speed (RPM) Kelajuan Tanpa Beban 回转速数	Max: 0 - 2,200 Hard: 1,900 Medium: 1,200 Soft: 500
Impacts Per Minute (IPM) Impak Per Minit 冲击数	Max: 0 - 2,700 Hard: 2,400 Medium: 1,700 Soft: 1,000
Max Fastening Torque Pemutaran Tenaga Maksimum 最大扭矩	700N-m (520ft.lbs.)
Dimensions (L x W x H) Dimensi 体积	170x81x276mm (6-11/16x3-3/16x10-7/8")
Net Weight Berat Bersih 淨重	2.3 - 2.7kg (5.1 - 6.0lbs.)

* All list price shown are for reference only (exclude SST).

* Semua harga yang ditunjukkan adalah untuk rujukan sahaja (tidak termasuk SST). 所有显示的建议零售价仅供参考 (不包括SST)。

Cordless
LED Flashlight
Vacuum Cleaner
Drilling / Fastening
Impact Drilling / Demolition
Cutting
Grinding / Smoothing
Sawing
Planing / Routing
Others
Outdoor Power Equipment





Li-ion Ah 6.0 | 5.0 | 4.0 | 3.0 | 2.0 | 1.5

DTW301RTJ | **DTW301Z** 12.7mm (1/2")
RM 2,790 | RM 1,503

Cordless Impact Wrench
Perengkuh Impak Tanpa Kord
充电式冲击套筒扳手

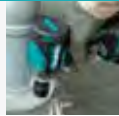

Pin detent



- 3 modes of reaction time for automatic stop available both in forward and reverse rotation modes

Standard Equipment: Belt Clip

- RTJ: 1x Rapid Charger, 2x 5.0Ah Battery, 1x Makpac Connector Box
- Z: Without Charger, Battery & Carrying Case



Fastening Capacities Keupayaan Pengancing 紧固能力	High Strength Bolt: M10 - M16 (3/8" - 5/8")
Square Drive Skrus Persegi 方形螺杆	Standard Bolt: M10 - M20 (3/8" - 3/4")
No Load Speed (RPM) Kelajuan Tanpa Beban 回转数	Max: 0 - 3,200 Hard: 2,600 Medium: 1,800 Soft: 1,000
Impacts Per Minute (IPM) Impak Per Minit 冲击数	Max: 0 - 4,000 Hard: 3,400 Medium: 2,600 Soft: 1,800
Max Fastening Torque Pemutaran Tenaga Maksimum 最大扭矩	330N-m (240ft.lbs.)
Dimensions (L x W x H) Dimensi 体积	144x81x246mm (5-5/8x3-3/16x9-11/16")
Net Weight Berat Bersih 净重	1.5 - 1.8kg (3.4 - 4.1lbs.)

DTW300RTJ | **DTW300Z** 12.7mm (1/2")
RM 2,790 | RM 1,503

Cordless Impact Wrench
Perengkuh Impak Tanpa Kord
充电式冲击套筒扳手



C ring



Reverse Rotation Auto Stop Mode
Mod auto berhenti untuk putaran terbalik 反转自动停止模式

- 3 modes of reaction time for automatic stop available both in forward and reverse rotation modes

Standard Equipment: Belt Clip, Shoulder Belt

- RTJ: 1x Rapid Charger, 2x 5.0Ah Battery, 1x Makpac Connector Box
- Z: Without Charger, Battery & Carrying Case



Fastening Capacities Keupayaan Pengancing 紧固能力	High Strength Bolt: M10 - M16 (3/8" - 5/8")
Square Drive Skrus Persegi 方形螺杆	Standard Bolt: M10 - M20 (3/8" - 3/4")
No Load Speed (RPM) Kelajuan Tanpa Beban 回转数	Max: 0 - 3,200 Hard: 2,600 Medium: 1,800 Soft: 1,000
Impacts Per Minute (IPM) Impak Per Minit 冲击数	Max: 0 - 4,000 Hard: 3,400 Medium: 2,600 Soft: 1,800
Max Fastening Torque Pemutaran Tenaga Maksimum 最大扭矩	330N-m (240ft.lbs.)
Dimensions (L x W x H) Dimensi 体积	144x81x246mm (5-5/8x3-3/16x9-11/16")
Net Weight Berat Bersih 净重	1.5 - 1.8kg (3.4 - 4.1lbs.)

DTW450RME | **DTW450RFE** | **DTW450Z** 12.7mm (1/2")
RM 2,353 | RM 2,190 | RM 1,215

Cordless Impact Wrench
Perengkuh Impak Tanpa Kord
充电式冲击套筒扳手

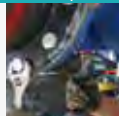

- Compact and lightweight design provide superior balance and control

Standard Equipment: Hook

- RME: 1x Rapid Charger, 2x 4.0Ah Battery
- RFE: 1x Rapid Charger, 2x 3.0Ah Battery
- Z: Without Charger, Battery & Carrying Case



Fastening Capacities Kapasiti 能力	Standard Bolt: M12 - M22 (1/2" - 7/8")
Square Drive Skrus Persegi 方形螺杆	High Tensile Bolt: M12 - M16 (1/2" - 5/8")
No Load Speed (RPM) Kelajuan Tanpa Beban 回转数	1,600
Impacts Per Minute (IPM) Impak Per Minit 冲击数	2,200
Max Fastening Torque Pemutaran Tenaga Maksimum 最大扭矩	440N-m (325 ft.lbs.)
Dimensions (L x W x H) Dimensi 体积	266x82x290mm (10-1/2"x3-1/4"x11-3/8")
Net Weight Berat Bersih 净重	3.1 - 3.4kg (7.6 - 6.9lbs)
Work Amount (approx.) Jumlah Kerja 工作量	120 pcs with BL1850B Bolts M16

DTW285RME | **DTW285RFE** | **DTW285Z** 12.7mm (1/2")
RM 2,457 | RM 2,293 | RM 1,318

Cordless Impact Wrench
Perengkuh Impak Tanpa Kord
充电式冲击套筒扳手



Reverse Rotation Auto Stop Mode
Mod auto berhenti untuk putaran terbalik 反转自动停止模式

- BL motor delivers 280N-m of max torque

Standard Equipment: Belt Clip

- RME: 1x Rapid Charger, 2x 4.0Ah Battery
- RFE: 1x Rapid Charger, 2x 3.0Ah Battery
- Z: Without Charger, Battery & Carrying Case

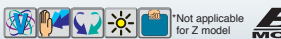

Fastening Capacities Kapasiti 能力	Standard Bolt: M10 - M20 (3/8" - 3/4")
Square Drive Skrus Persegi 方形螺杆	High Tensile Bolt: M10 - M16 (3/8" - 5/8")
No Load Speed (RPM) Kelajuan Tanpa Beban 回转数	Hard: 0 - 2,800 Medium: 0 - 2,100 Soft: 0 - 1,600
Impacts Per Minute (IPM) Impak Per Minit 冲击数	Hard: 0 - 3,500 Medium: 0 - 2,600 Soft: 0 - 1,800
Max Fastening Torque Pemutaran Tenaga Maksimum 最大扭矩	280N-m (210ft.lbs.)
Dimensions (L x W x H) Dimensi 体积	147x79x249mm (5-3/4"x3-1/8"x9-3/4")
Net Weight Berat Bersih 净重	1.5 - 1.8kg (3.2 - 3.9lbs)
Work Amount (approx.) Jumlah Kerja 工作量	275 pcs with BL1850B High Tensile Bolt M16

DTW251RME | **DTW251RFE** | **DTW251Z** 12.7mm (1/2")
RM 2,110 | RM 1,947 | RM 972

Cordless Impact Wrench
Perengkuh Impak Tanpa Kord
充电式冲击套筒扳手

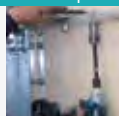

- High power, compact and lightweight 4-pole motor

Standard Equipment: Belt Clip

- RME: 1x Rapid Charger, 2x 4.0Ah Battery
- RFE: 1x Rapid Charger, 2x 3.0Ah Battery
- Z: Without Charger, Battery & Carrying Case

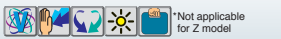

Fastening Capacities Kapasiti 能力	Standard Bolt: M10 - M16 (3/8" - 5/8")
Square Drive Skrus Persegi 方形螺杆	High Tensile Bolt: M10 - M14 (3/8" - 9/16")
No Load Speed (RPM) Kelajuan Tanpa Beban 回转数	0 - 2,100
Impacts Per Minute (IPM) Impak Per Minit 冲击数	0 - 3,200
Max Fastening Torque Pemutaran Tenaga Maksimum 最大扭矩	230N-m (170ft.lbs.)
Dimensions (L x W x H) Dimensi 体积	165x79x234mm (6-1/2"x3-1/8"x9-1/4")
Net Weight Berat Bersih 净重	1.5 - 1.8kg (3.2 - 3.9lbs)
Work Amount (approx.) Jumlah Kerja 工作量	250 pcs with BL1850B Bolt M14

* All list price shown are for reference only (exclude SST).

* Semua harga yang ditunjukkan adalah untuk rujukan sahaja (tidak termasuk SST). 所有显示的建议零售价仅供参考 (不包括SST)。



Li-ion Ah 6.0 5.0 4.0 3.0 2.0 1.5

DTW181RFE DTW181Z 12.7mm (1/2")
RM 1,757 RM 780

Cordless Impact Wrench
Perengkuh Impak Tanpa Kord
充电式冲击套筒扳手



- Ideal for working in tight spaces

Standard Equipment: Belt Clip

- RFE: 1x Rapid Charger, 2x 3.0Ah Battery
- Z: Without Charger, Battery & Carrying Case



Fastening Capacities Kapastiti 能力	Standard Bolt: M8 - M16 (5/16" - 5/8") High Strength Bolt: M6 - M12 (1/4" - 1/2")
Square Drive Skrü Persegi 方形螺柱	12.7 mm (1/2")
No Load Speed (RPM) Kelajuan Tanpa Beban 回转速	Hard: 0 - 2,400 Soft: 0 - 1,300
Impacts Per Minute (IPM) Impak Per Minit 冲击数	Hard: 0 - 3,600 Soft: 0 - 2,000
Max Fastening Torque Pemutaran Tenaga Maksimum 最大扭矩	210N-m (155ft.lbs.)
Dimensions (L x W x H) Dimensi 体积	151x79x235mm (5-15/16"x3-1/8"x9-1/4")
Net Weight Berat Bersih 淨重	1.2 - 1.5kg (2.7 - 3.4lbs.)

DTW180Z 9.5mm (3/8")
RM 780

Cordless Impact Wrench
Perengkuh Impak Tanpa Kord
充电式冲击套筒扳手



- Ideal for working in tight spaces

Standard Equipment: Belt Clip

- Z: Without Charger & Battery



Fastening Capacities Kapastiti 能力	Standard Bolt: M8 - M16 (5/16" - 5/8") High Tensile Bolt: M6 - M12 (1/4" - 1/2")
Square Drive Skrü Persegi 方形螺柱	9.5 mm (3/8")
No Load Speed (RPM) Kelajuan Tanpa Beban 回转速	Hard: 0 - 2,400 Soft: 0 - 1,300
Impacts Per Minute (IPM) Impak Per Minit 冲击数	Hard: 0 - 3,600 Soft: 0 - 2,000
Max Fastening Torque Pemutaran Tenaga Maksimum 最大扭矩	180N-m (130ft.lbs.)
Dimensions (L x W x H) Dimensi 体积	144x79x235mm (5-5/8"x3-1/8"x9-1/4")
Net Weight Berat Bersih 淨重	1.2 - 1.5kg (2.7 - 3.4lbs.)

DTW190RME DTW190RFE DTW190Z 12.7mm (1/2")
RM 1,713 RM 1,550 RM 573

Cordless Impact Wrench
Perengkuh Impak Tanpa Kord
充电式冲击套筒扳手



- 190N-m (140ft.lbs.) of Max torque optimal for scaffold building

- RME: 1x Rapid Charger, 2x 4.0Ah Battery
- RFE: 1x Rapid Charger, 2x 3.0Ah Battery
- Z: Without Charger, Battery & Carrying Case



Fastening Capacities Kapastiti 能力	Standard Bolt: M8 - M16 (5/16" - 5/8") High Tensile Bolt: M8 - M12 (5/16" - 1/2")
Square Drive Skrü Persegi 方形螺柱	12.7mm (1/2")
No Load Speed (RPM) Kelajuan Tanpa Beban 回转速	0 - 2,300
Impacts Per Minute (IPM) Impak Per Minit 冲击数	0 - 3,000
Max Fastening Torque Pemutaran Tenaga Maksimum 最大扭矩	190N-m (140ft.lbs.)
Overall Length Dimensi 体积	176mm (6-15/16")
Net Weight Berat Bersih 淨重	1.4 - 1.8kg (3.2 - 3.9lbs.)

Model No. 型号	Square Drive Skrü Pemacu Persegi 方形传动螺柱	No Load Speed (rpm) Kelajuan Tanpa Beban 回转速	Impacts Per Minute (IPM) Impak Per Minit 冲击数	Max. Fastening Torque (N.m) Maksimum Tenaga Pemutaran Pengancing 最大扭矩	Overall Length (mm) Panjang Keseluruhan 总长度	Net Weight Berat Bersih 淨重	BL MOTOR	XPT
Cordless Impact Wrench								
DTW1001	19mm (3/4")	0-1,800/ 0-1,000/ 0-900	0 - 2,200 / 0 - 2,000 / 0 - 1,800	1,050 (780ft.lbs.)	229	3.4kg (7.5lbs)	●	
DTW1002	12.7mm (1/2")	0-1,800/ 0-1,000/ 0-900	0 - 2,200 / 0 - 2,000 / 0 - 1,800	1,000 (740ft.lbs.)	229	3.3kg (7.3lbs)	●	
DTW800	11.2mm (7/16") Hex.	0-1,800/ 0-1,000/ 0-900	0 - 2,200 / 0 - 2,000 / 0 - 1,800	800 (590ft.lbs.)	229	3.4kg (8.2lbs)	●	
DTW700 / DTW701	12.7mm (1/2")	0-2,200/ 0-1,900/ 0-1,200/ 0-500	0-2,700/ 0-2,400/ 0-1,700/ 0-1,000	700 (520ft.lbs.)	170	2.3kg (5.1lbs)	●	●
DTW450	12.7mm (1/2")	1,600	2,200	440 (325ft.lbs.)	266	3.1kg (7.6lbs)	●	
DTW300 / DTW301	12.7mm (1/2")	0-3,200/ 0-2,600/ 0-1,800/ 0-1,000	0-4,000/ 0-3,400/ 0-2,600/ 0-1,800	330 (240ft.lbs.)	144	1.5kg (3.4lbs)	●	●
DTW285	12.7mm (1/2")	0-2,800/ 0-2,100/ 1,600	0 - 3,500 / 0 - 2,600 / 0 - 1,800	280 (210ft.lbs.)	147	1.5kg (3.2lbs)	●	●
DTW251	12.7mm (1/2")	0-2,100	0 - 3,200	230 (170ft.lbs.)	165	1.5kg (3.2lbs)	●	●
DTW181	12.7mm (1/2")	0-2,400/ 0-1,300	0 - 3,600/ 0-2,000	210 (155ft.lbs.)	151	1.2kg (2.7lbs)	●	●
DTW180	9.5mm (3/8")	0-2,400/ 0-1,300	0 - 3,600/ 0-2,000	180 (130ft.lbs.)	144	1.2kg (2.7lbs)	●	●
DTW190	12.7mm (1/2")	0-2,300	0 - 3,000	190 (140ft.lbs.)	176	1.4kg (3.2lbs)	●	●

* All list price shown are for reference only (exclude SST).

* Semua harga yang ditunjukkan adalah untuk rujukan sahaja (tidak termasuk SST). 所有显示的建议零售价仅供参考 (不包括SST)。

Cordless
Tempat Aplikasi: 18V-18V

LED Flashlight
Lampu Sinar LED
- LED LIGHT

Vacuum Cleaner
Penyedut Hava
- BLUET

Drilling / Fastening
Gali / Pasang
- M12 / 18V

Impact Drilling / Demolition
Gali / Pasang
- 12.5MM, 18V/21V

Cutting
Memotong
- 18V

Grinding / Smoothing
Mencik / Mengkilap
- 18V / 18V

Sawing
Gali
- 18V

Planing / Routing
Mencik / Mengkilap
- 18V / 18V

Others
Lain-lain
- 18V

Outdoor Power Equipment
Alatan Kuat Daya Luar
- 18V-18V

Makita
18V



Cordless Ratchet Wrench

Perengkuh Ratchet Tanpa Kord
充电式棘轮扳手

Supplied with two socket adapters

Dibekalkan dengan dua penyesuai soket
随附两个套筒转接头



Net Weight
Berat Bersih 淨重
1.2kg

Max Fastening Torque
Tenaga Pemutaran
Penggancing Maksimum 最大紧固扭力
47.5N.m



Can also be used as a hand ratchet wrench
Boleh juga digunakan sebagai perengkuh tangan
也可作为手动工具使用

Forward / Reverse rotation change

Turn the reversing lever to the A side for clockwise rotation or to the B side for counterclockwise rotation
Kawalan tuas
Putar tuas ke sisi A untuk putaran mengikut arah jam, atau ke sisi B untuk putaran berlawanan arah jarum jam
反转杆动作
将反转杆转至 A 侧以进行顺时针旋转, 或转至 B 侧, 以进行逆时针旋转

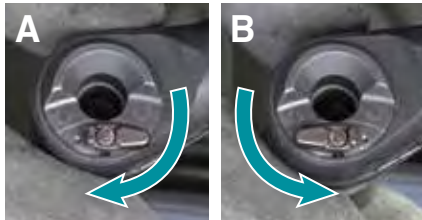

Able to tighten 13mm nut onto M8 threaded rod

Mampu mengetatkan nat 13mm ke batang berulir M8
转接孔可紧固 M8 螺栓/螺帽 (作为 13mm 套筒使用)



LED job light

with preglow and afterglow functions
Lampu kerja LED dengan fungsi preglow dan afterglow
具有预发光和余辉功能的LED工作灯



Tool Bag (Optional Accessories)
Beg Alat Makita 工具袋
Part No. 831271-6

DWR180Z 9.5mm (3/8")
RM 1,222

Cordless Ratchet Wrench
Perengkuh Ratchet Tanpa Kord
充电式棘轮扳手

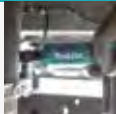

• Supplied with two socket adapters for compatibility with a variety of sockets



Standard Equipment: Socket Adapter
• Z: Without Charger & Battery



Capacity Kapasiti 能力	Standard Bolt: M5 - M12 (3/16 - 1/2") High Strength Bolt: M5 - M10 (3/16 - 3/8") 9.5mm (3/8") 6.35mm (1/4")
Square Drive Kepala Segi Empat 方形头	
No Load Speed (RPM) Kelajuan Tanpa Beban 回转数	0 - 800
Max Fastening Torque Tenaga Pemutaran Penggancing Maksimum 最快扭转	47.5N.m (420in.lbs.)
Flats Width Lebar Flat 单位宽度	13mm (1/2")
Angle Head Size Saiz Kepala Sudut 角头尺寸	Diameter: 31mm (1-7/32") Height: 25.5mm (1")
Dimensions (L x W x H) Dimensi 体积	369x79x87mm (14-1/2x3-1/8x3-7/16")
Net Weight Berat Bersih 淨重	1.2 - 1.6kg (2.6 - 3.5lbs.)

DTL063Z 9.5mm (3/8")
RM 1,218

Cordless Angle Impact Wrench
Perengkuh Impak Sudut Tanpa Kord
充电式角冲击套筒扳手



• Compact angle head for easy access to bolts in tight places



Standard Equipment: Belt Clip
• Z: Without Charger & Battery



Fastening Capacities Kapasiti 能力	Standard Bolt: M4 - M12 (5/32" - 1/2") High Tensile Bolt: M4 - M8 (5/32" - 5/16") 9.5mm (3/8")
Square Drive Skrus Persegi 方形螺柱	
No Load Speed (RPM) Kelajuan Tanpa Beban 回转数	0 - 2,000
Impacts Per Minute (IPM) Impak Per Minit 冲击数	0 - 3,000
Max Fastening Torque Pemutaran Tenaga Maksimum 最大扭力	60N.m (N/A ft.lbs.)
Dimensions (L x W x H) Dimensi 体积	387x78x116mm (15-1/4"x3-1/16"x4-9/16")
Net Weight Berat Bersih 淨重	1.4 - 2.0kg (3.1 - 4.3lbs)

* All list price shown are for reference only (exclude SST).

* Semua harga yang ditunjukkan adalah untuk rujukan sahaja (tidak termasuk SST). 所有显示的建议零售价仅供参考 (不包括SST)。

Cordless
Target Kuching
LED Flashlight
Lampu Cahaya LED
LED 1000000
Vacuum Cleaner
Penyedut Vakuum
MUSK
Drilling / Fastening
Drool / Penggali
M10 / 3/8"
Impact Drilling / Demolition
Drool / Demolish
反冲钻 / 震裂机
Cutting
Pemotong
VDR
Grinding / Sanding
Pengkilan / Pasut
DR11 / 1/2"
Sawing
Gergaji
DR10
Planing / Routing
Pengaliran / Rongkah
M10 / 3/8"
Drivers
Lanjar
DR10 / 3/8"
Outdoor Power Equipment
Alat Kuasa Luar
DR10 / 3/8"
Makita
1911



Li-ion Ah 6.0 5.0 4.0 3.0 2.0 1.5

DHR242RTE RM 2,745	DHR242RME RM 2,600	DHR242RFE RM 2,437	DHR242Z 24mm (15/16") RM 1,460
------------------------------	------------------------------	------------------------------	--

Cordless Combination Hammer
Tukul Kombinasi Tanpa Kord
充电式冲击电钻电锤

• 3-Mode operation; rotation only, hammering with rotation and hammering only

Standard Equipment: Depth Gauge, Side Grip

- RTE: 1x Rapid Charger, 2x 5.0Ah Battery
- RME: 1x Rapid Charger, 2x 4.0Ah Battery
- RFE: 1x Rapid Charger, 2x 3.0Ah Battery
- Z: Without Charger, Battery & Carrying Case

ACCESSORIES (Optional)
DX06 Dust Extraction System Set
Part No. 199561-6

Impact Energy Kekuatan Impak 单次最大锤击力	2J
Capacity Kapasiti 能力	Concrete: 24mm (15/16") Steel: 13mm (1/2") Wood: 27mm (1-1/16")
Impacts Per Minute (IPM) Impak Per Minit 冲击数	0 - 4,700
No Load Speed (RPM) Kelajuan Tanpa Beban 回转数	0 - 950
Dimensions (L x W x H) Dimensi 体积	328x85x213mm (12-7/8"x3-3/8"x8-3/8")
Net Weight Berat Bersih 净重	3.1 - 3.8kg (6.7 - 8.4lbs)
Work Amount (approx.) Jumlah Kerja 工作量	60 holes with BL1850B Mansory Drill ø10.5mm Concrete Depth 60mm

DHR241RFE RM 2,017	DHR241Z 20mm (13/16") RM 1,040	441 Wh
------------------------------	--	--------

Cordless Combination Hammer
Tukul Kombinasi Tanpa Kord
充电式冲击电钻电锤

• 3-Mode operation; rotation only, hammering with rotation and hammering only

Standard Equipment: Depth Gauge, Side Grip

- RFE: 1x Rapid Charger, 2x 3.0Ah Battery
- Z: Without Charger, Battery & Carrying Case

Impact Energy Kekuatan Impak 单次最大锤击力	1.9J
Capacity Kapasiti 能力	Concrete: 20mm (13/16") Steel: 13mm (1/2") Wood: 26mm (1")
Impacts Per Minute (IPM) Impak Per Minit 冲击数	0 - 4,000
No Load Speed (RPM) Kelajuan Tanpa Beban 回转数	0 - 1,100
Dimensions (L x W x H) Dimensi 体积	417x84x219mm (16-3/8"x3-5/16"x8-5/8")
Net Weight Berat Bersih 净重	3.2 - 4.0kg (7.1 - 8.8lbs)
Work Amount (approx.) Jumlah Kerja 工作量	133 holes with BL1850B Mansory drill ø16.5mm Concrete Depth 40mm

DHR202RME RM 2,235	DHR202RFE RM 2,072	DHR202Z 20mm (13/16") RM 1,095	441 Wh
------------------------------	------------------------------	--	--------

Cordless Combination Hammer
Tukul Kombinasi Tanpa Kord
充电式冲击电钻电锤

• 3-Mode operation; rotation only, hammering with rotation and hammering only

Standard Equipment: Depth Gauge, Side Grip

- RME: 1x Rapid Charger, 2x 4.0Ah Battery
- RFE: 1x Rapid Charger, 2x 3.0Ah Battery
- Z: Without Charger, Battery & Carrying Case

Capacity Kapasiti 能力	Concrete: 20mm (13/16") Steel: 13mm (1/2") Wood: 26mm (1")
Impacts Per Minute (IPM) Impak Per Minit 冲击数	0 - 4,000
No Load Speed (RPM) Kelajuan Tanpa Beban 回转数	0 - 1,100
Dimensions (L x W x H) Dimensi 体积	358x84x259mm (14-1/8"x3-5/16"x10-1/4")
Net Weight Berat Bersih 净重	3.2 - 4.0kg (7.1 - 8.8lbs)
Work Amount (approx.) Jumlah Kerja 工作量	130 holes with BL1850B Mansory drill ø6.5mm Concrete Depth 60mm

DHR182ZWJ 18mm (11/16") RM 1,957
--

Cordless Combination Hammer
Tukul Kombinasi Tanpa Kord
充电式冲击电钻电锤

• Auto-start Wireless System (AWS) connects to vacuum cleaner with Bluetooth

Standard Equipment: Side Grip, Depth Gauge

- ZWJ: Without Charger, Battery, Come with 1x Dust Extraction System Set, 1x Makpac Connector Box

Come with
DX05 Dust Extraction System Set
Part No. 199658-1

Impact Energy Kekuatan Impak 单次最大锤击力	EPTA-Procedure 05/2009: 1.7J Our experimental conditions: 1.6J
Capacity Kapasiti 能力	Concrete: 18mm (11/16") Core Bit: 35mm (1-3/8") Diamond Core Bit (Dry Type): 32mm (1-1/4") Steel: 13mm (1/2") Wood: 24mm (15/16")
Impacts Per Minute (IPM) Impak Per Minit 冲击数	0 - 5,000
No Load Speed (RPM) Kelajuan Tanpa Beban 回转数	0 - 1,350
Max Output Keluasan Maksima 最大输出	450W
Dimensions (L x W x H) Dimensi 体积	301x82x285mm (11-7/8"x3-1/4"x11-1/4")
Net Weight Berat Bersih 净重	2.4 - 3.2kg (5.3 - 7.0lbs.)
Work Amount (approx.) Jumlah Kerja 工作量	140 holes with BL1850B Mansory Drill ø6.5mm Concrete 40N/mm2 Depth 60mm

DHR171RTE RM 2,343	DHR171RFE RM 2,035	DHR171Z 17mm (11/16") RM 1,060
------------------------------	------------------------------	--

Cordless Rotary Hammer
Tukul Putar Tanpa Kord
充电式电锤

• 2-Mode operation; rotation only, or hammering with rotation only

Standard Equipment: Side Grip, Depth Gauge

- RTE: 1x Rapid Charger, 2x 5.0Ah Battery
- RFE: 1x Rapid Charger, 2x 3.0Ah Battery
- Z: Without Charger, Battery & Carrying Case

Impact Energy Kekuatan Impak 单次最大锤击力	EPTA-Procedure 05/2009: 1.2J Our experimental conditions: 1.1J
Capacity Kapasiti 能力	Concrete: 17mm (11/16") Steel: 10mm (3/8") Wood: 13mm (1/2")
Impacts Per Minute (IPM) Impak Per Minit 冲击数	0 - 4,800
No Load Speed (RPM) Kelajuan Tanpa Beban 回转数	0 - 680
Dimensions (L x W x H) Dimensi 体积	273x86x211mm (10-3/4"x3-3/8"x8-5/16")
Net Weight Berat Bersih 净重	2.1 - 2.8kg (4.6 - 6.2lbs)
Work Amount (approx.) Jumlah Kerja 工作量	220 holes with BL1850B Mansory Drill ø6mm Concrete 40N/mm2 Depth 40mm

* All list price shown are for reference only (exclude SST).

* Semua harga yang ditunjukkan adalah untuk rujukan sahaja (tidak termasuk SST). 所有显示的建议零售价仅供参考 (不包括SST)。

Cordless
Tempat Kerja
LED Flashlight
Vacuum Cleaner
Drilling / Fastening
Impact Drilling / Demolition
Cutting
Grinding / Smoothing
Sawing
Planing / Routing
Others
Outdoor Power Equipment





Li-ion Ah 6.0 5.0 4.0 3.0 2.0 1.5

DHR165RME | **DHR165RFE** | **DHR165Z** 16mm (5/8") 430

Cordless Rotary Hammer
Tukul Putar Tanpa Kord
充电式电锤



- 2-Mode operation; rotation only, or hammering with rotation only

Standard Equipment: Depth Gauge, Side Grip

- RME: 1x Rapid Charger, 2x 4.0Ah Battery
- RFE: 1x Rapid Charger, 2x 3.0Ah Battery
- Z: Without Charger, Battery & Carrying Case



Impact Energy Kekuatan Impak 单次最大冲击力	1.3J
Capacity Kapasiti 能力	Concrete: 16mm (5/8") Steel: 13mm (1/2") Wood: 24mm (15/16")
Impacts Per Minute (IPM) Impak Per Minit 冲击数	0 - 5,300
No Load Speed (RPM) Kelajuan Tanpa Beban 回转数	0-1,600
Dimensions (L x W x H) Dimensi 体积	297x79x253mm (11-3/4"x3-1/8"x10")
Net Weight Berat Bersih 净重	2.3 - 3.0kg (5.0 - 6.6lbs)
Work Amount (approx.) Jumlah Kerja 工作量	225 holes with BL1850B Mansory drill ø6.5mm Concrete Depth 30mm

DHK180Z RM 3,400

Cordless Power Scraper
Pengikis Kuasa Tanpa Kord
充电式铲平机

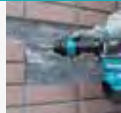

- High power & low vibration

Standard Equipment: Hook

- Z: Without Charger & Battery



Impact Energy Kekuatan Impak 单次最大冲击力	EPTA-Procedure 05/2009: 3.1J Our experimental conditions: 3.9J
Impact Per Minute (IPM) Impak Per Minit 冲击数	0 - 3,200
Dimensions (L x W x H) Dimensi 体积	368x99x211mm (14-1/2"x3-7/8"x8-5/16")
Net Weight Berat Bersih 净重	3.3 - 3.6 kg (7.3 - 7.9 lbs.)
Continuous Usage Time (approx.) Masa Penggunaan Berterusan 连续使用时间	17min with BL1850B

DUT130RFE | **DUT130Z** | **DUT131Z** RM 2,787 | RM 1,810 | RM 2,548

Cordless Mixer
Pengadun Tanpa Kord
充电式搅拌机

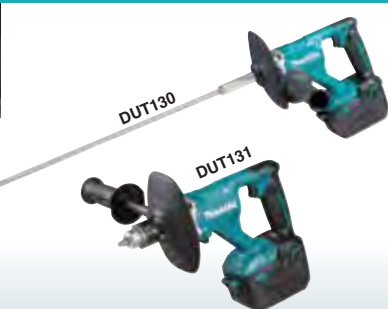

- Battery cover prevents concrete to be scattered on the battery

Standard Equipment:
DUT130: Mixing Blade, Shaft, Shaft Holder, Side Grip, Front Cover, Wrenches, Tool Bag

- DUT131: Front Cover, Side Grip, Chuck Key, Tool Bag
- RFE: 1x Rapid Charger, 2x 3.0Ah Battery
- Z: Without Charger & Battery



Chuck Capacity Kapasiti Chuck 夹头能力	1.5 - 13mm (1/16 - 1/2") DUT131
Blade Diameter Diameter Bilah 锯片直径	165mm (6-1/2") DUT130
Shank size of tool holder portion Batang Saiz 柄部尺寸	M12 or M14 DUT130
No Load Speed (RPM) Kelajuan Tanpa Beban 回转数	High: 0 - 1,300 Low: 0 - 350
Dimensions (L x W x H) Dimensi 体积	916x89x231mm DUT130 (36"x3-1/2"x9-1/8") 307x89x231mm DUT131 (12-1/8"x3-1/2"x9-1/8")
Net Weight Berat Bersih 净重	2.5 - 2.8 kg (5.6 - 6.3 lbs.) DUT130 2.7 - 3.0kg (5.8 - 6.6lbs.) DUT131
Continuous Usage Time (approx.) Masa Penggunaan Berterusan 连续使用时间	25min with BL1850B One Liquid Paint 4L - High Speed

DCS553Z 150mm (5-7/8") RM 2,087

Cordless Metal Cutter
Pemotong Logam Tanpa Kord
充电式金属切割机



- Built-in dust collection box for cleaner work environment

Standard Equipment: TCT Saw Blade, Hex Wrench, Safety Goggles, Guide Rule

- Z: Without Charger & Battery



Max Output Keluaran Maksima 最大输出	600W
Blade Diameter Diameter Bilah 锯片直径	150mm (5-7/8")
Hole Diameter Diameter Lubang 孔直径	20mm (13/16")
Max Cutting Capacity Kapasiti Pemotongan Maksimum 最大切割能力	90°: 57.5mm (2-1/4")
No Load Speed (RPM) Kelajuan Tanpa Beban 回转数	4,200
Dimensions (L x W x H) Dimensi 体积	267x186x250mm (10-1/2"x7-3/8"x9-7/8")
Net Weight Berat Bersih 净重	2.8 - 3.1kg (6.1 - 6.8lbs.)
Work Amount (approx.) Jumlah Kerja 工作量	125 cuts with BL1850B Saw Blade - Carbon Steel Pipe Ø 34mm, Thickness 3.2mm

DCS552Z 136mm (5-3/8") RM 1,290 430

Cordless Metal Cutter
Pemotong Logam Tanpa Kord
充电式金属切割机



- Built-in dust collection box for cleaner work environment

Standard Equipment: TCT Saw Blade (B-07319), Hex Wrench, Safety Goggles

- Z: Without Charger & Battery



Max Output Keluaran Maksima 最大输出	370W
Blade Diameter Diameter Bilah 锯片直径	136mm (5-3/8")
Hole Diameter Diameter Lubang 孔直径	20mm (13/16")
Max Cutting Capacity Kapasiti Pemotongan Maksimum 最大切割能力	90°: 50.5mm (2")
No Load Speed (RPM) Kelajuan Tanpa Beban 回转数	3,600
Dimensions (L x W x H) Dimensi 体积	348x196x203mm (13-3/4"x7-3/4"x8")
Net Weight Berat Bersih 净重	2.4 - 2.7kg (5.3 - 6.0lbs.)
Work Amount (approx.) Jumlah Kerja 工作量	125 cuts with BL1850B Saw Blade - Carbon Steel Pipe Ø 34mm, Thickness 3.2mm

* All list price shown are for reference only (exclude SST).

* Semua harga yang ditunjukkan adalah untuk rujukan sahaja (tidak termasuk SST). 所有显示的建议零售价仅供参考 (不包括SST)。

Cordless Impact Driver
LED Flashlight
Vacuum Cleaner
Drilling / Fastening
Impact Drilling / Demolition
Cutting
Grinding / Sanding
Sawing
Planing / Routing
Others
Outdoor Power Equipment





Li-ion Ah 6.0 5.0 4.0 3.0 2.0 1.5

DCS551RFJ | **DCS551Z** 150mm (5-7/8")
RM 2,835 | RM 1,860

Cordless Metal Cutter
Pemotong Logam Tanpa Kord
充电式金属切割机

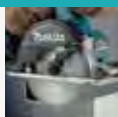

- Cuts 51mm (2") conduit in a single pass

Standard Equipment: TCT Saw Blade (B-46296), Hex Wrench, Safety Goggles

- RFJ: 1x Rapid Charger, 2x 3.0Ah Battery, 1x Makpac Connector Box
- Z: Without Charger, Battery & Carrying Case



DCS550RFE | **DCS550Z** 136mm (5-3/8")
RM 2,140 | RM 1,165

Cordless Metal Cutter
Pemotong Logam Tanpa Kord
充电式金属切割机



- Carbide-tipped 30T blade for cutting a wide range of materials

Standard Equipment: TCT Saw Blade (B-07319), Hex Wrench, Safety Goggles

- RFE: 1x Rapid Charger, 2x 3.0Ah Battery
- Z: Without Charger, Battery & Carrying Case



DJS130RFE | **DJS130Z** 1.3mm
RM 2,783 | RM 1,808

Cordless Metal Shear
Pemotong Logam Tanpa Kord
充电式电剪



- 360° swivel shear head for increased cutting convenience

Standard Equipment: Hex Wrench

- RFE: 1x Rapid Charger, 2x 3.0Ah Battery
- Z: Without Charger, Battery & Carrying Case

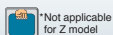

DJS161Z 1.6mm
RM 1,808

Cordless Straight Shear
Pemotong Logam Lurus Tanpa Kord
充电式电剪压穿式



- High cutting capacity: cuts up to 1.6mm thick mild steel sheet

Standard Equipment: Hex Wrench, Thickness Gauge

- Z: Without Charger & Battery

DJS101Z 1.0mm
RM 2,133

Cordless Metal Shear
Pemotong Logam Tanpa Kord
充电式电剪



- Easy curve cutting with a smooth edge

Standard Equipment: Hex Wrench

- Z: Without Charger & Battery

Blade Diameter Diameter Bilah 锯片直径	150mm (5-7/8")
Max Cutting Capacity Kapastiti Pemotongan Maksimum 最大切割能力	90°: 57.5mm (2-1/4")
No Load Speed (RPM) Kelajuan Tanpa Beban 回转数	3,900
Dimensions (L x W x H) Dimensi 体积	332x158x231mm (13-1/8"x6-1/4"x9-1/8")
Net weight Berat Bersih 净重	2.5 - 2.8kg (5.5 - 6.2lbs)
Work Amount (approx.) Jumlah Kerja 工作量	210 pcs with BL1850B Saw Blade - Wire Tube Ø 38.1mm, Wall Thickness 1.4mm

Blade Diameter Diameter Bilah 锯片直径	136mm (5-3/8")
Max Cutting Capacity Kapastiti Pemotongan Maksimum 最大切割能力	90°: 51mm (2")
No Load Speed (RPM) Kelajuan Tanpa Beban 回转数	3,600
Dimensions (L x W x H) Dimensi 体积	348x180x201mm (13-3/4"x7-1/8"x7-7/8")
Net weight Berat Bersih 净重	2.2 - 2.6kg (4.9 - 5.7lbs)
Work Amount (approx.) Jumlah Kerja 工作量	216 pcs with BL1850B Saw Blade - Wire Tube Ø 38.1mm, Wall Thickness 1.4mm

Capacity Kapastiti 能力	Steel up to 400 N/mm ² : 1.3mm Steel up to 600 N/mm ² : 1.0mm 2,800
No Load Speed (RPM) Kelajuan Tanpa Beban 回转数	3,600
Dimensions (L x W x H) Dimensi 体积	350x80x193mm (13-3/4"x3-1/8"x7-5/8")
Net weight Berat Bersih 净重	2.3 - 2.6kg (5.0 - 5.8lbs)
Work Amount (approx.) Jumlah Kerja 工作量	200 pcs with BL1850B Cutting (SPCC Sheet 1.0 x 600mm)

Capacity Kapastiti 能力	Steel up to 400 N/mm ² : 1.6mm Steel up to 600 N/mm ² : 1.2mm Aluminum up to 200 N/mm ² : 2.5mm
Strokes Per Minute (SPM) Kelajuan Strok 冲程速度	4,300
Dimensions (L x W x H) Dimensi 体积	362x78x118mm (14-1/4"x3-1/16"x4-5/8")
Net weight Berat Bersih 净重	1.8 - 2.2kg (4.1 - 4.8lbs)
Work Amount (approx.) Jumlah Kerja 工作量	95 pcs with BL1850B Cutting (Thin Metal Plate 1.2mm)

Capacity Kapastiti 能力	Steel up to 400 N/mm ² : 1.0mm Steel up to 600 N/mm ² : 0.7mm Aluminum up to 200 N/mm ² : 2.5mm
Strokes Per Minute (SPM) Kelajuan Strok 冲程速度	4,300
Dimensions (L x W x H) Dimensi 体积	364x78x118mm (14-3/8"x3-1/16"x4-5/8")
Net weight Berat Bersih 净重	1.8 - 2.2kg (4.0 - 4.7lbs)
Work Amount (approx.) Jumlah Kerja 工作量	150 pcs with BL1850B Cutting (Steel sheet SUS430 600x1.0mm)

* All list price shown are for reference only (exclude SST).

* Semua harga yang ditunjukkan adalah untuk rujukan sahaja (tidak termasuk SST). 所有显示的建议零售价仅供参考 (不包括SST)。

Cordless
Tempa Apa Saja

LED Flashlight
Lampu Senter LED
- LED BRIGHT

Vacuum Cleaner
Penyedut Vakuum
- 2.5L

Drilling / Fastening
Gergaji / Pengikat
- 1/2" - 3/8"

Impact Drilling / Demolition
Gergaji / Pecah
- 1/2" - 3/8"

Cutting / Trimming
Pemotong / Potong
- 1/2"

Grinding / Smoothing
Gergaji / Halus
- 1/2"

Sawing
Gergaji
- 1/2"

Planing / Routing
Pajuan / Trogam
- 1/2"

Others
Lain-lain
- 1/2"

Outdoor Power Equipment
Alatan Kuasa Luar
- 1/2"

Makita
18V LXT



Li-ion Ah 6.0 | 5.0 | 4.0 | 3.0 | 2.0 | 1.5

DJN161Z 1.6mm (16Ga)
RM 2,398

430

Cordless Nibbler
Tukul Pemutar Skru Bergerudi
Tanpa Kord
充电式电冲剪



- Ideal for cutting roofing sheet metal at thicknesses up to 16 gauge

Standard Equipment: Hex Wrench, Wrench, Punch, Die

- Z: Without Charger & Battery

Capacity
Kapasiti 能力 Steel up to 400 N/mm²: 1.6mm
Steel up to 600 N/mm²: 1.2mm
Aluminum up to 200 N/mm²: 2.5mm

Min. Cutting Radius
Radius Pemotongan Minimum 最小切割半径
Strokes Per Minute (SPM)
Kelajuan Strok 冲程速度 Inside edge: 45mm (1-3/4")
Outside edge: 50mm (2")
1,900

Dimensions (L x W x H)
Dimensi 体积 313x78x189mm
(12-3/8"x3-1/16"x7-7/16")

Net weight
Berat Bersih 淨重 1.9 - 2.3kg (4.3 - 5.0lbs)

Work Amount (approx.)
Jumlah Kerja 工作量 30m with BL1850B
Cutting (Steel Plate 1mm)

DRV250Z | **DRV150Z**
RM 8,315 | RM 8,315

Cordless Rivet Gun
Penembak Rivet Tanpa Kord
充电式拉钉枪

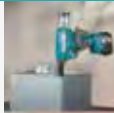

- Compact center height for increased maneuverability against a wall

Standard Equipment: Grease (191D57-7), Accessory Set, Belt Clip

- Z: Without Charger & Battery



Max Pulling Force
Kekuatan Tarikan Maksimum 拉钉力量 20kN **DRV250**
10kN **DRV150**

Length of Stroke
Panjang Strok 冲程长度 30mm (1-3/16") **DRV250**
25mm (1") **DRV150**

Dimensions (L x W x H)
Dimensi 体积 320x79x287mm **DRV250**
(12-5/8"x3-1/8"x11-1/4")
310x80x287mm **DRV150**
(12-1/4"x3-1/8"x11-1/4")

Net Weight
Berat Bersih 淨重 2.1 - 2.4kg (4.6 - 5.2lbs.) **DRV250**
1.9 - 2.2kg (4.3 - 5.0lbs.) **DRV150**

Work Amount (approx.)
Jumlah Kerja 工作量 2,000 rivets with BL1850B **DRV250**
2,300 rivets with BL1850B **DRV150**
Mandrel diameter: Ø4.8mm

Cordless Rebar Tying Tool

Alat Pengikat Rebar Tanpa Kord 充电式钢筋捆绑机

Easy to load with tie wire reel



1
Push the release lever
Tekan tuas pelepas 按下释放按钮

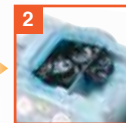

2
Put a reel and pass a wire through the hole
Letakkan keluli wayar melalui lubang
将钢筋穿进导线轴

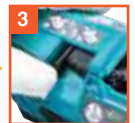

3
Release the lock lever
Lepaskan tuas kunci 释放锁定按钮



*Jumlah Kerja 工作量
Work Amount
with BL1850B
(D10 x D10 Rebar)
5,300
times
(approx.)

Tying Speed
Kelajuan mengikat 捆绑速度
0.95
second with
(D10 x D10 Rebar)

1 Reel about **120** times
(D10 x D10 Rebar)

Accessories
Aksesori 配件
Tie Wire Set
(Ø0.8mm) 50pcs/ box
Part No. 199137-9



Applicable Rebars: D10 x D10 - (D13 x 2) x (D13 x 2)

	Tying Capacity (2 pcs of rebars)			Tying Capacity (3 pcs of rebars)			Tying Capacity (4 pcs of rebars)		
	D10 (#3)	D13 (#4)	D16 (#5)	D10 (#3) x D10 (#3)	D13 (#4) x D13 (#4)		D10 (#3) x D10 (#3)	D13 (#4) x D13 (#4)	
D10 (#3)	✓	✓	✓	✓	✓		✓	✓	
D13 (#4)	✓	✓	✓	✓	✓		✓	✓	
D16 (#5)	✓	✓	✓	✓	—		✓	✓	

(# means perimeter length: cm)

DTR180ZJ
RM 5,697

Cordless Rebar Tying Tool
Alat Pengikat Rebar Tanpa Kord
充电式钢筋捆绑机



- Continuous actuation mode for efficient continuous rebar tying

Standard Equipment: Hex Wrench, Hook

- ZJ: With 1x Makpac Connector Box, Without Charger & Battery



ACCESSORIES
(Optional)

Extension Handle Set
Part No. 191M27-0

Tie Wire
Wayar Pengikat 绑线 ø0.8mm

Applicable Rebars
Keluli yang Sesuai 适用钢筋 D10 x D10 - (D13 x 2) x (D13 x 2)

Dimensions (L x W x H)
Dimensi 体积 304x93x318mm
(12"x3-2/3"x12-1/2")

Net Weight
Berat Bersih 淨重 2.3 - 2.6kg (5.1 - 5.7lbs.)

Work Amount (approx.)
Jumlah Kerja 工作量 5300 times with BL1850B
Tying (D10 x D10 Rebar)



DTR180

Models and specs may vary by country

* All list price shown are for reference only (exclude SST).

* Semua harga yang ditunjukkan adalah untuk rujukan sahaja (tidak termasuk SST). 所有显示的建议零售价仅供参考 (不包括SST)。



Li-ion Ah 6.0 5.0 4.0 3.0 2.0 1.5

DPP200ZK

RM 17,500

Cordless Hole Puncher
Penebuk Lubang Tanpa Kord
充电式油压冲孔机



*Not compatible with 2.0Ah, 1.5Ah batteries



- Punches up to 20 mm Holes through Steel Plate up to 8 mm thick

Standard Equipment: Punch, Dice, Hex Wrench, Spanner, Bar for fastening nuts, Grip, Oil

• ZK: With Carrying Case, Without Charger & Battery



Capacity Keupayaan 能力	Steel: 20mm (13/16") Stainless Steel: 20mm (13/16")
Max Throat Depth Kedalaman Maksimum 最大深度	40mm (1-9/16")
Dimensions (L x W x H) Dimensi 体积	417x127x315mm (16-3/8"x5"x12-3/8")
Net Weight Berat Bersih 淨重	10.5kg (23.2lbs.)
Work Amount (approx.) Jumlah Kerja 工作量	110 holes with BL1830B on General steel for Ø20 mm with 6mm Thickness

Cordless Threaded Rod Cutter

Pemotong Batang Keluli Tanpa Kord 充电式螺纹杆切割机

LED job light
Lampu kerja LED
LED工作灯

*Jumlah Kerja 工作量
Work Amount
with BL1850B
(Mild steel M10)

1,330
rods
(approx.)

Performs stable cutting even on the floor

Pemotongan yang stabil walaupun di lantai
即使在地板上也能进行稳定的切割

Blade Cover

Can be used as a rod support
Penutup pisau boleh digunakan sebagai penyangga rod
刀片盖可用作杆支撑

Rod Guide There are two rod guide positions
Terdapat dua kedudukan panduan tuas 有两个杆导向位置

◀[1]
Size of threaded rod
W3/8, M10

◀[2]
Size of threaded rod
M8, M6

Cutting Capacity
Kapasiti 能力

M6 - M10
(W3/8")

Accessories
Aksesori 配件

Cutter Blade Set
Replacing the cutting dice



	Type	Cutting Capacities	Part No.
inch screw	Mild steel •Stainless steel	W3/8	199080-2
	Mild steel •Stainless steel	M6	199086-0
mm screw	Mild steel •Stainless steel	M8	199084-4
	Mild steel	M10	199082-8

DSC102ZJ

RM 5,638

Cordless Threaded Rod Cutter

Pemotong Batang Keluli Tanpa Kord
充电式螺纹杆切割机



- More Compact & High Productivity

Standard Equipment: Cutter Blade Set W3/8 (199080-2), Hex Socket Head Bolt, Blade Cover, Depth Gauge, Thumb Screw, Hex Wrench

• ZJ: With 1x Makpac Connector Box, Without Charger & Battery



*Not applicable for Z model



Capacity Kapasiti 能力	Mild Steel: W3/8, M10, M8, M6 Stainless Steel: W3/8, M8, M6
Min. Cutting Length Panjang Pemotongan Minimum 最小切割长度	20mm (13/16")
Dimensions (L x W x H) Dimensi 体积	199x103x308mm (7-7/8"x4-1/16"x12-1/8")
Net Weight Berat Bersih 淨重	2.8 - 3.2kg (6.2 - 7.0lbs.)
Work Amount (approx.) Jumlah Kerja 工作量	1330 rods with BL1850B (Mild steel M10)

DSC121ZK

RM 19,053

Cordless Threaded Rod Cutter

Pemotong Batang Berulir Tanpa Kord
充电式螺纹杆切割机



- Power Cutting at High Speed

Standard Equipment: W3/8 Cutter Blade, Stand, Oil, Hex Wrench

• ZK: With 1x Makpac Connector Box, Without Charger & Battery



Capacity Kapasiti 能力	Steel: 8 - 12mm (5/16" - 1/2")
Cutting Speed (sec) Kelajuan Bilah 刀片速度	3.0
Dimensions (L x W x H) Dimensi 体积	212x323x260mm (8-3/8"x12-3/4"x10-1/4")
Net Weight Berat Bersih 淨重	6.0kg (13.2lbs.)
Work Amount (approx.) Jumlah Kerja 工作量	420 rods with BL1850B (Mild steel M12)

* All list price shown are for reference only (exclude SST).

* Semua harga yang ditunjukkan adalah untuk rujukan sahaja (tidak termasuk SST). 所有显示的建议零售价仅供参考 (不包括SST)。

Cordless
Tempat Kerja
LED
Flashlight
Lampu Kerja LED
LEDWORK
Vacuum Cleaner
Penyedut Debu
BLVAC
Drilling / Fastening
Gergaji / Pengikat
M10 / M8
Impact Drilling / Demolition
Gergaji / Pemukul
M3, M4, M5, M6, M8
Cutting
Penebuk
M10
Grinding / Smoothing
Gergaji / Mulus
Sawing
Gergaji
M10
Planing / Routing
Pajuan / Tegakan
M10 / M8
Others
Lain-lain
M10
Outdoor Power Equipment
Alatan Kuasa Luar
M10-M12
Thakita
1987

18V

LXT

Li-ion Ah 6.0 5.0 4.0 3.0 2.0 1.5

DSC162Z | DSC163ZK

RM 20,457 | RM 21,190

Cordless Steel Rod CutterPemotong Keluli Tanpa Kord
充电式钢筋切割机

- Spark free cutting of rebar and steel rod ideal for use in sensitive areas

Standard Equipment: Wrench, Hex Wrench, Oil supply

- Z: Without Charger & Battery
- ZK: With Carrying Case, Without Charger & Battery

DSC162
440 mmDSC163
BL MOTOR**DSC191Z**

RM 22,118

Cordless Steel Rod CutterPemotong Keluli Tanpa Kord
充电式钢筋切割机

- Ideal for cutting steel bars laid in concrete slab

Standard Equipment: Wrench, Hex Wrench, Oil supply

- Z: Without Charger & Battery



440 mm

**DSC251ZK**

RM 9,213

Cordless Steel Rod CutterPemotong Keluli Tanpa Kord
充电式钢筋切割机

- Ideal for edge cutting of threaded rods and rebars

Standard Equipment: Tipped Saw, Dust Bag, Side Grip, Hex Wrench

- ZK: With Carrying Case, Without Charger & Battery



BL ADT MOTOR

**DPB180Z**

RM 2,717

Cordless Portable Band SawGergaji Pita Tanpa Kord
充电式带锯机

- 6-Setting variable speed control dial enables user to match the speed to the application

Standard Equipment: Band Saw Blade, Hex Wrench

- Z: Without Charger & Battery



430 mm

**DPB182Z**

RM 1,657

Cordless Portable Band SawGergaji Pita Tanpa Kord
充电式带锯机

- Aluminum housing improves rigidity and prevents blade coming off

Standard Equipment: Band Saw Blade, Hex Wrench

- Z: Without Charger & Battery



DPB182

VIDEO CLIP
Models and specs may vary by country

Cutting Capacity Kapasiti Pemotongan 切割能力	Dia.: 3 - 16mm (1/8" - 5/8")
Cutting Speed (sec) Kelajuan Memotong 切割速度	4.0 DSC162 2.8 DSC163
Dimensions (L x W x H) Dimensi 体积	380x108x265mm DSC162 (15"x4-1/4"x10-3/8") 360x108x276mm DSC163 (14-1/8"x4-1/4"x10-7/8")
Net Weight Berat Bersih 淨重	7.1kg (15.7lbs) DSC162 6.9kg (15.2lbs) DSC163
Work Amount (approx.) Jumlah Kerja 工作量	191 pcs with BL1850B Cutting (Rebar ø16) 233 pcs with BL1850B DSC163 Cutting (Rebar ø16)

Cutting Capacity Kapasiti Pemotongan 切割能力	Dia.: 3 - 20mm (1/8" - 3/4")
Cutting Speed (sec) Kelajuan Memotong 切割速度	6.5
Dimensions (L x W x H) Dimensi 体积	412x212x284mm (16-1/5"x8-3/8"x11-1/8")
Net Weight Berat Bersih 淨重	11.1 - 11.2kg (24.5 - 24.6lbs)
Work Amount (approx.) Jumlah Kerja 工作量	333 pcs with BL1850B Cutting (Rebar ø10)

Blade Diameter Diameter Bilah 锯片直径	110mm (4-5/16")
Cutting Capacity Kapasiti Pemotongan 切割能力	Dia.: 10 - 25mm (3/8" - 1")
No Load Speed (RPM) Kelajuan Tanpa Beban 回转数	2,200
Dimensions (L x W x H) Dimensi 体积	471x137x139mm (18-1/2"x5-3/8"x5-1/2")
Net Weight Berat Bersih 淨重	3.9 - 4.0kg (8.7 - 8.8lbs)
Work Amount (approx.) Jumlah Kerja 工作量	60 pcs with BL1850B Cutting Rebar SD345 490N/mm2 D25

Capacity Kapasiti 能力	Round: 120mm (4-3/4") Rectangular workpiece w/o stand: 120x120mm (4-3/4"x4-3/4")
Blade Speed Kelajuan Bilah 刀片速度	1.4-2.7m/s (275-530ft/min.)
Dimensions (L x W x H) Dimensi 体积	523x231x313mm (20-5/8"x9-1/8"x12-3/8")
Net Weight Berat Bersih 淨重	6.8 - 7.1kg (14.9 - 15.7lbs)
Work Amount (approx.) Jumlah Kerja 工作量	200 pcs with BL1850B Cutting (Steel Wire Tube Ø38.1mm (1.4mm Thickness))

Capacity Kapasiti 能力	Round: 64mm (2-1/2") Rectangular: 64x64mm (2-1/2"x2-1/2")
Blade Speed Kelajuan Bilah 刀片速度	3.2m/s (630ft/min.)
Blade Size Saiz Bilah 锯片尺寸	Length: 835mm (32-7/8") Width: 13mm (1/2") Thickness: 0.5mm (0.02")
Dimensions (L x W x H) Dimensi 体积	477x197x229mm (18-3/4"x7-3/4"x9")
Net Weight Berat Bersih 淨重	3.8 - 4.1kg (8.3 - 9.0lbs.)
Work Amount (approx.) Jumlah Kerja 工作量	210 pcs with BL1850B Cutting (Steel Wire Tube Ø38.1mm (1.4mm Thickness))

* All list price shown are for reference only (exclude SST).

* Semua harga yang ditunjukkan adalah untuk rujukan sahaja (tidak termasuk SST). 所有显示的建议零售价仅供参考 (不包括SST)。

18V

LXT

Li-ion Ah 6.0 5.0 4.0 3.0 2.0 1.5

Cordless Portable Band Saw

Gergaji Pita Tanpa Kord 充电式带锯机



DPB183

Blade Speed
Kelajuan Bilah 锯片速度
0 - 3.2m/s
(0 - 630ft/min.)

**Light weight with
One Hand operated
convenient working at high level**

Ringan dan boleh diguna dengan satu tangan,
senang untuk kerja pada tahap tinggi
轻巧可单手操作, 便于高水平工作



DPB184

DPB183Z

RM 2,188

**Cordless Portable
Band Saw**
Gergaji Pita Tanpa Kord
充电式带锯机



**NEW
BARU | 新**



- Constant speed control minimizes the reduction in blade speed to provide stable cutting

Standard Equipment:
Band Saw Blade, Hex Wrench

• Z: Without Charger & Battery



DPB183



VIDEO CLIP

Models and specs may vary by country

Capacity Keupayaan 能力	Round: 66mm (2-5/8") Square: 66 x 66mm (2-5/8 x 2-5/8")
Blade Speed Kelajuan Bilah 锯片速度	0 - 3.2 m/s (0 - 630ft/min.)
Blade Size Saiz Bilah 锯片尺寸	Length: 835mm (32-7/8") Width: 13mm (1/2") Thickness: 0.5mm (0.02")
Dimensions (L x W x H) Dimensi 体积	392x174x242mm (15-1/2x6-7/8x9-1/2")
Net Weight Berat Bersih 净重	3.6 - 3.9kg (7.9 - 8.6lbs.)
Work Amount (approx.) Jumlah Kerja 工作量	250 pcs with BL1850B Cutting (Steel Wire Tube Ø38.1mm) (1.4mm Thickness)

DPB184Z

RM 2,005

**Cordless Portable
Band Saw**
Gergaji Pita Tanpa Kord
充电式带锯机



**NEW
BARU | 新**



- Constant speed control minimizes the reduction in blade speed to provide stable cutting

Standard Equipment:
Band Saw Blade, Hex Wrench

• Z: Without Charger & Battery



DPB184



VIDEO CLIP

Models and specs may vary by country

Capacity Keupayaan 能力	Round: 51mm (2") Square: 51 x 51mm (2 x 2")
Blade Speed Kelajuan Bilah 锯片速度	0 - 3.2 m/s (0 - 630ft/min.)
Blade Size Saiz Bilah 锯片尺寸	Length: 730mm (28-3/4") Width: 13mm (1/2") Thickness: 0.5mm (0.02")
Dimensions (L x W x H) Dimensi 体积	373x162x223mm (14-3/4x6-3/8x8-3/4")
Net Weight Berat Bersih 净重	3.3 - 3.6kg (7.3 - 7.9lbs.)
Work Amount (approx.) Jumlah Kerja 工作量	400 pcs with BL1850B Cutting (Steel Wire Tube Ø25.4mm) (1.2mm Thickness)

DCC500Z

RM 1,348

Cordless Dustless Cutter
Pemotong Tanpa Kord
充电式切割机

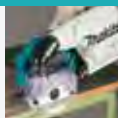

**NEW
BARU | 新**



- Auto-start Wireless System (AWS) connects to compatible vacuum cleaners with Bluetooth

Standard Equipment:
Dust Bag, Hex Wrench

• Z: Without Charger & Battery



DPB184



VIDEO CLIP

Models and specs may vary by country

**ACCESSORIES
(Optional)**
Water Supply
Cover Set A
Part No. 191M48-2

Blade Diameter Diameter Bilah 锯片直径	125mm (5")
Hole Diameter Diameter Lubang 孔直径	20mm (13/16")
Max Cutting Capacity Kapasiti Pemotongan Maksimum 最大切割能力	90°: 40mm (1-9/16") 45°: 27mm
No Load Speed (RPM) Kelajuan Tanpa Beban 回转数	8,500
Dimensions (L x W x H) Dimensi 体积	283x158x172mm (11-1/8x6-1/4x6-3/4")
Net Weight Berat Bersih 净重	2.5 - 3.0kg (5.5 - 6.6lbs.)
Work Amount (approx.) Jumlah Kerja 工作量	16 m with BL1850B Cutting 600mm groove in brick Depth 10mm (Dry type 125mm Diamond Wheel)

* All list price shown are for reference only (exclude SST).

* Semua harga yang ditunjukkan adalah untuk rujukan sahaja (tidak termasuk SST). 所有显示的建议零售价仅供参考 (不包括SST)。

18V **LXT** **Li-ion** Ah 6.0 | 5.0 | 4.0 | 3.0 | 2.0 | 1.5

AWS

Auto - start Wireless System

Switch on the tool, and Vacuum cleaner is activated

Sistem permulaan wayarles automatik 无线自动启动系统

It has been impossible, but now Vacuum cleaner can be automatically activated by Cordless tools with our newly developed wireless system
hidupkan alat dan pembersih vakum akan diaktifkan pembersih vakum boleh diaktifkan secara automatik oleh alat tanpa kord dengan Sistem permulaan wayarles automatik baru
启动工具, 吸尘器自动开启我们新研发的无线系统可以通过无线工具自动激活吸尘器



Bluetooth **AWS connects to power tool with Bluetooth**

AWS menyambungkan alat melalui Bluetooth AWS通过蓝牙连接电动工具

The Bluetooth® word mark and logos are registered trademarks owned by the Bluetooth SIG, Inc. and any use of such marks by Makita is under license. Other trademarks and trade names are those of their respective owners.

ADT

Automatic Torque Drive Technology
Teknologi Tork Automatik
自动扭力驱动科技

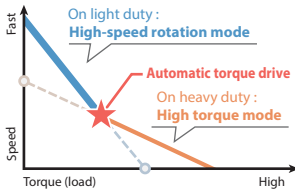

Automatically changes the cutting speed according to load conditions for an optimum operation
Fungsi pertukaran khalajuan automatik 自动变速功能

AFT

Active Feedback Sensing Technology
Teknologi Sensor Maklum Balas Automatik
自动回馈感应科技

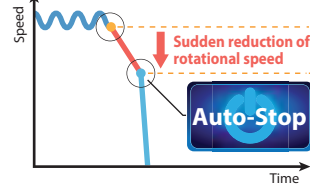

Shuts down the tool to protect the user, if the rotation speed suddenly slows down
Jika khalajuan putaran tiba-tiba dikurangkan, alat akan dimatikan secara automatik untuk melindungi pengguna
若旋转速度突然降低, 工具将自动关闭以保护保护使用者

XLOCK

Kunci Mata Pengisar X
砂轮X锁



DGA419, DGA519 only

Just one click to attach the accessories and easy removal just simply pull the lever
Hanya dengan satu klik untuk memasang aksesori dan mudah dilepaskan hanya tarik tuas
只需单击一下即可安装配件, 只需按下杆即可轻松拆卸

BL MOTOR

Motor tanpa berus
无碳刷马达

Faster Cutting with High power and High torque brushless motor
Pemotongan yang lebih cepat dengan motor tanpa berus berkuasa tinggi
无碳刷马达使切割更快



Electric brake is activated after the tool is switched off
Brek elektrik diaktifkan selepas alat dimatikan
电子自动刹车在工具关闭后被启动

Electric Brake System
Sistem Brek Elektrik
电子自动刹车系统

DGA419Z 100mm (4")
RM 1,707

Cordless Angle Grinder
Pengisar Sudut Tanpa Kord
充电式角向磨光机

Paddle Switch

Suis Pemicu 扳机开关



• X-LOCK for toolless accessory changes

Standard Equipment: Grinding Wheel (E-00496), Wheel Cover, Side Grip

• Z: Without Charger & Battery



Wheel Diameter Diameter Roda 轮片直径	100mm (4")
Hole Diameter Diameter Lubang 孔直径	22.23mm (7/8")
Max Wheel Thickness Ketebalan Roda Maksimum 最大轮片厚度	6mm (1/4")
No Load Speed (RPM) Khalajuan Tanpa Beban 回转数	3,000 - 8,500
Dimensions (L x W x H) Dimensi 体积	396x117x147mm (15-1/2"x4-5/8"x5-3/4")
Net Weight Berat Bersih 淨重	2.4 - 3.0kg (5.3 - 6.6lbs.)

DGA411Z 100mm (4")
RM 1,103

Cordless Angle Grinder
Pengisar Sudut Tanpa Kord
充电式角向磨光机

Top Slide Switch

Suis Gelangsar Atas 顶部滑动开关
Convenient for left & right handed
Mudah diguna dengan tangan kiri atau kanan 方便左右手



• Spiral bevel gear for more efficient transfer of energy

Standard Equipment: Grinding Wheel (A-80852), Wheel Cover, Side Grip, Lock Nut Wrench

• Z: Without Charger & Battery



Wheel Diameter Diameter Roda 轮片直径	100mm (4")
No Load Speed (RPM) Khalajuan Tanpa Beban 回转数	3,000 - 8,500
Dimensions (L x W x H) Dimensi 体积	BL1850B: 382x117x140mm (15"x4-5/8"x5-1/2")
Net Weight Berat Bersih 淨重	2.2 - 2.8kg (4.8 - 6.1lbs.)
Continuous Usage Time (approx.) Masa Penggunaan Berterusan 连续使用时间	8 min with BL1850B Metal Sanding Pressing Load of 30N, 3000rpm

* All list price shown are for reference only (exclude SST).

* Semua harga yang ditunjukkan adalah untuk rujukan sahaja (tidak termasuk SST). 所有显示的建议零售价仅供参考 (不包括SST)。

Cordless
Terdapat Tanpa Kord

LED Flashlight
Lampu Cahaya LED
LED BRIGHT

Vacuum Cleaner
Pembersih Vakum
BUKUK

Drilling / Fastening
Dua / Pengikat
MUTU BUKUK

Impact Drilling / Demolition
Dua / Demolisi
Dua / Demolisi

Cutting
Pemotongan
WUK

Grinding / Sanding
Pengisar / Pasir
Dua / Pasir

Sawing
Gergaji
Dua / Gergaji

Planing / Routing
Penghalus / Tumpang
Dua / Tumpang

Others
Lain-lain
Dua / Lain-lain

Outdoor Power Equipment
Alat Kuasa Luar
Dua / Alat Kuasa Luar

Makita
Makita



Li-ion Ah 6.0 5.0 4.0 3.0 2.0 1.5

DGA414Z 100mm (4")
RM 1,637

Cordless Angle Grinder
Pengisar Sudut Tanpa Kord
充电式角向磨光机



Top Slide Switch

Suis Gelangsar Atas 顶部滑动开关
Convenient for left & right handed
Mudah diguna dengan tangan kiri atau kanan 方便左右手



- Auto-start Wireless System (AWS) connects to compatible vacuum cleaners with Bluetooth

Standard Equipment: Grinding Wheel (A-80852), Wheel Cover, Side Grip, Lock Nut Wrench

- Z: Without Charger & Battery



Wheel Diameter Diameter Roda 轮片直径	100mm (4")
No Load Speed (RPM) Kelajuan Tanpa Beban 回转数	3,000 - 8,500
Dimensions (L x W x H) Dimensi 体积	BL1850B: 382x117x147mm (15"x4-5/8"x5-3/4")
Net Weight Berat Bersih 净重	2.2 - 2.8kg (4.9 - 6.3lbs.)
Continuous Usage Time (approx.) Masa Penggunaan Berterusan 连续使用时间	8 min with BL1850B Metal Sanding Pressing Load of 30N, 3000rpm

DGA418Z 100mm (4")
RM 1,707

Cordless Angle Grinder
Pengisar Sudut Tanpa Kord
充电式角向磨光机



Paddle Switch

Suis Pemacu 扳机开关



- Auto-start Wireless System (AWS) connects to compatible vacuum cleaners with Bluetooth

Standard Equipment: Grinding Wheel (A-80852), Wheel Cover, Side Grip, Lock Nut Wrench

- Z: Without Charger & Battery



Wheel Diameter Diameter Roda 轮片直径	100mm (4")
No Load Speed (RPM) Kelajuan Tanpa Beban 回转数	3,000 - 8,500
Dimensions (L x W x H) Dimensi 体积	BL1850B: 382x117x146mm (15"x4-5/8"x5-3/4")
Net Weight Berat Bersih 净重	2.2 - 2.9kg (5.0 - 6.3lbs.)
Continuous Usage Time (approx.) Masa Penggunaan Berterusan 连续使用时间	8 min with BL1850B Metal Sanding Pressing Load of 30N, 3000rpm

DGA406RME | **DGA406RFE** | **DGA406Z** 100mm (4")
RM 2,173 | RM 2,008 | RM 1,033

Cordless Angle Grinder
Pengisar Sudut Tanpa Kord
充电式角向磨光机



Top Slide Switch

Suis Gelangsar Atas 顶部滑动开关
Convenient for left & right handed
Mudah diguna dengan tangan kiri atau kanan 方便左右手



- Electric brake for increased operator safety

Standard Equipment: Grinding Wheel (A-80852), Wheel Cover, Side Grip, Lock Nut Wrench

- RME: 1x Rapid Charger, 2x 4.0Ah Battery
- RFE: 1x Rapid Charger, 2x 3.0Ah Battery
- Z: Without Charger, Battery & Carrying Case



Wheel Diameter Diameter Roda 轮片直径	100mm (4")
No Load Speed (RPM) Kelajuan Tanpa Beban 回转数	8,500
Dimensions (L x W x H) Dimensi 体积	362x117x146mm (14-1/4"x4-5/8"x5-3/4")
Net Weight Berat Bersih 净重	2.18 - 2.77kg (4.81 - 6.12lbs)
Work Amount (approx.) Jumlah Kerja 工作量	12 m with BL1850B Cutting Concrete Depth 10mm

DGA408RME | **DGA408RFE** | **DGA408Z** 100mm (4")
RM 2,242 | RM 2,078 | RM 1,103

Cordless Angle Grinder
Pengisar Sudut Tanpa Kord
充电式角向磨光机



Paddle Switch

Suis Pemacu 扳机开关



- Efficiency for heavy-duty grinding applications

Standard Equipment: Grinding Wheel (A-80852), Wheel Cover, Side Grip, Lock Nut Wrench

- RME: 1x Rapid Charger, 2x 4.0Ah Battery
- RFE: 1x Rapid Charger, 2x 3.0Ah Battery
- Z: Without Charger, Battery & Carrying Case



Wheel Diameter Diameter Roda 轮片直径	100mm (4")
No Load Speed (RPM) Kelajuan Tanpa Beban 回转数	8,500
Dimensions (L x W x H) Dimensi 体积	362x117x146mm (14-1/4"x4-5/8"x5-3/4")
Net Weight Berat Bersih 净重	2.18 - 2.80kg (4.81 - 6.17lbs)
Work Amount (approx.) Jumlah Kerja 工作量	12 m with BL1850B Cutting Concrete Depth 10mm

DGA404RTE | **DGA404RFE** | **DGA404Z** 100mm (4")
RM 2,248 | RM 1,938 | RM 963

Cordless Angle Grinder
Pengisar Sudut Tanpa Kord
充电式角向磨光机



Top Slide Switch

Suis Gelangsar Atas 顶部滑动开关
Convenient for left & right handed
Mudah diguna dengan tangan kiri atau kanan 方便左右手



- Efficient internal cooling for optimum performance

Standard Equipment: Grinding Wheel (A-80852), Wheel Cover, Side Grip, Lock Nut Wrench

- RTE: 1x Rapid Charger, 2x 5.0Ah Battery
- RFE: 1x Rapid Charger, 2x 3.0Ah Battery
- Z: Without Charger, Battery & Carrying Case



Wheel Diameter Diameter Roda 轮片直径	100mm (4")
No Load Speed (RPM) Kelajuan Tanpa Beban 回转数	8,500
Dimensions (L x W x H) Dimensi 体积	362x117x140mm (14-1/4"x4-5/8"x5-1/2")
Net Weight Berat Bersih 净重	2.10 - 2.71kg (4.63 - 5.98lbs)
Work Amount (approx.) Jumlah Kerja 工作量	12 m with BL1850B Cutting Concrete Depth 10mm



DGA404/DGA454/DGA504
Models and specs may vary by country

* All list price shown are for reference only (exclude SST).

* Semua harga yang ditunjukkan adalah untuk rujukan sahaja (tidak termasuk SST). 所有显示的建议零售价仅供参考 (不包括SST)。

Cordless
LED Flashlight
Vacuum Cleaner
Drilling / Fastening
Impact Drilling / Demolition
Cutting / Smoothing
Sawing
Planing / Routing
Others
Outdoor Power Equipment



18V

LXT

Li-ion Ah 6.0 5.0 4.0 3.0 2.0 1.5

DGA405RFE **DGA405Z** 100mm (4")
RM 1,973 RM 998

Cordless Angle Grinder
Pengisar Sudut Tanpa Kord
充电式角向磨光机



Paddle Switch
Suis Pemacu 扳机开关



- Efficient internal cooling for optimum performance

Standard Equipment: Grinding Wheel (A-80852), Wheel Cover, Side Handle, Lock Nut Wrench

- RFE: 1x Rapid Charger, 2x 3.0Ah Battery
- Z: Without Charger, Battery & Carrying Case



*Not applicable for Z model

BL MOTOR **XPT** **ADT AFT**

Wheel Diameter Diameter Roda 轮片直径	100mm (4")
No Load Speed (RPM) Kelajuan Tanpa Beban 回转数	8,500
Dimensions (L x W x H) Dimensi 体积	362x117x140mm (14-1/4"x4-5/8"x5-1/2")
Net Weight Berat Bersih 淨重	2.08 - 2.69kg (4.59 - 5.94lbs)
Work Amount (approx.) Jumlah Kerja 工作量	12 m with BL1850B Cutting Concrete Depth 10mm

DGA402RFE **DGA402Z** 100mm (4")
RM 1,532 RM 557

Cordless Angle Grinder
Pengisar Sudut Tanpa Kord
充电式角向磨光机



Top Slide Switch
Suis Gelangsar Atas 顶部滑动开关
Convenient for left & right handed
Mudah diguna dengan tangan kiri atau kanan 方便左右手



- Spiral bevel gear for more efficient transfer of energy

Standard Equipment: Grinding Wheel (A-80852), Wheel Cover, Side Grip, Lock Nut Wrench

- RFE: 1x Rapid Charger, 2x 3.0Ah Battery
- Z: Without Charger, Battery & Carrying Case



*Not applicable for Z model

BL MOTOR **XPT** **ADT AFT**

Wheel Diameter Diameter Roda 轮片直径	100mm (4")
No Load Speed (RPM) Kelajuan Tanpa Beban 回转数	11,000
Dimensions (L x W x H) Dimensi 体积	317x118x118mm (12-1/2"x4-5/8"x4-5/8")
Net Weight Berat Bersih 淨重	1.90 - 2.51kg (4.19 - 5.5 lbs)
Work Amount (approx.) Jumlah Kerja 工作量	13.5 m with BL1850B Cutting Concrete Depth 5mm

DGA456RFE **DGA456Z** 115mm (4-1/2")
RM 2,028 RM 1,053

Cordless Angle Grinder
Pengisar Sudut Tanpa Kord
充电式角向磨光机

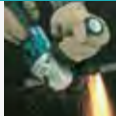

Top Slide Switch
Suis Gelangsar Atas 顶部滑动开关
Convenient for left & right handed
Mudah diguna dengan tangan kiri atau kanan 方便左右手



- Efficiency for heavy-duty grinding applications

Standard Equipment: Grinding Wheel (A-80640), Wheel Cover, Side Handle, Lock Nut Wrench

- RFE: 1x Rapid Charger, 2x 3.0Ah Battery
- Z: Without Charger, Battery & Carrying Case



*Not applicable for Z model

BL MOTOR **XPT** **ADT AFT** (BRAKE)

Wheel Diameter Diameter Roda 轮片直径	115mm (4-1/2")
No Load Speed (RPM) Kelajuan Tanpa Beban 回转数	8,500
Dimensions (L x W x H) Dimensi 体积	362x130x151mm (14-1/4"x5-1/8"x5-15/16")
Net Weight Berat Bersih 淨重	2.34 - 3.03kg (5.17 - 6.67lbs)
Work Amount (approx.) Jumlah Kerja 工作量	12 m with BL1850B Cutting Concrete Depth 10mm

DGA458RFE **DGA458Z** 115mm (4-1/2")
RM 2,098 RM 1,123

Cordless Angle Grinder
Pengisar Sudut Tanpa Kord
充电式角向磨光机



Paddle Switch
Suis Pemacu 扳机开关



- Electric brake for increased operator safety

Standard Equipment: Grinding Wheel (A-80640), Wheel Cover, Side Handle, Lock Nut Wrench

- RFE: 1x Rapid Charger, 2x 3.0Ah Battery
- Z: Without Charger, Battery & Carrying Case



*Not applicable for Z model

BL MOTOR **XPT** **ADT AFT** (BRAKE)

Wheel Diameter Diameter Roda 轮片直径	115mm (4-1/2")
No Load Speed (RPM) Kelajuan Tanpa Beban 回转数	8,500
Dimensions (L x W x H) Dimensi 体积	362x130x151mm (14-1/4"x5-1/8"x5-15/16")
Net Weight Berat Bersih 淨重	2.34 - 3.03kg (5.17 - 6.67lbs)
Work Amount (approx.) Jumlah Kerja 工作量	12 m with BL1850B Cutting Concrete Depth 10mm

DGA452RME **DGA452RFE** **DGA452Z** 115mm (4-1/2")
RM 1,722 RM 1,557 RM 582

Cordless Angle Grinder
Pengisar Sudut Tanpa Kord
充电式角向磨光机



Top Slide Switch
Suis Gelangsar Atas 顶部滑动开关
Convenient for left & right handed
Mudah diguna dengan tangan kiri atau kanan 方便左右手



- Compact barrel grip for easy handling

Standard Equipment: Grinding Wheel (A-80640), Wheel Cover, Side Handle, Lock Nut Wrench

- RME: 1x Rapid Charger, 2x 4.0Ah Battery
- RFE: 1x Rapid Charger, 2x 3.0Ah Battery
- Z: Without Charger, Battery & Carrying Case



*Not applicable for Z model

BL MOTOR **XPT** **ADT AFT**

Wheel Diameter Diameter Roda 轮片直径	115mm (4-1/2")
No Load Speed (RPM) Kelajuan Tanpa Beban 回转数	11,000
Dimensions (L x W x H) Dimensi 体积	317x129x126mm (12-1/2"x5-1/8"x5")
Net Weight Berat Bersih 淨重	2.06 - 2.71kg (4.53 - 5.97lbs)
Work Amount (approx.) Jumlah Kerja 工作量	25 m with BL1850B Cutting Concrete Depth 5mm

* All list price shown are for reference only (exclude SST).

* Semua harga yang ditunjukkan adalah untuk rujukan sahaja (tidak termasuk SST). 所有显示的建议零售价仅供参考 (不包括SST)。

18V

LXT

Li-ion Ah 6.0 5.0 4.0 3.0 2.0 1.5

Cordless Angle Grinder

Pengisar Sudut Tanpa Kord
充电式角向磨光机

XLOCK

JUST ONE CLICK TO ATTACH THE ACCESSORIES AND EASY REMOVAL JUST SIMPLY PULL THE LEVER

Hanya dengan satu klik untuk memasang aksesoris dan mudah dilepas hanya tarik tuas

只需单击一下即可安装配件，只需按下拉杆即可轻松拆卸



Variable speed control dial

Dial kawalan kelajuan ubah 变速控制拨盘

Wheel release lever

Pelepas roda 轮片释放杆

Paddle Switch

Suis Pemacu 扳机开关

INSTALLATION



REMOVAL

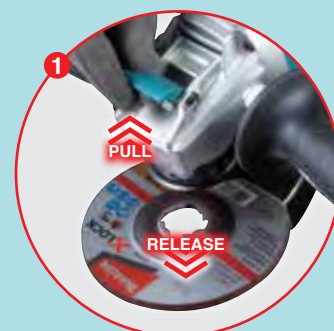

DGA519Z 125mm (5")

RM 1,747

Cordless Angle Grinder
Pengisar Sudut Tanpa Kord
充电式角向磨光机



Paddle Switch

Suis Pemacu 扳机开关



- X-LOCK for toolless accessory changes

Standard Equipment: Grinding Wheel (E-00402),
Wheel Cover, Side Grip

• Z: Without Charger & Battery

BL MOTOR XPT ADT AFT BRAKE XLOCK

Wheel Diameter Diameter Roda 轮片直径	125mm (5")
Hole Diameter Diameter Lubang 孔直径	22.23mm (7/8")
Max Wheel Thickness Ketebalan Roda Maksimum 最大轮片厚度	6mm (1/4")
No Load Speed (RPM) Kelajuan Tanpa Beban 回转数	3,000 - 8,500
Dimensions (L x W x H) Dimensi 体积	396x140x147mm (15-1/2"x5-1/2"x5-3/4")
Net Weight Berat Bersih 净重	2.5 - 3.1kg (5.5 - 6.8lbs.)

DGA511Z 125mm (5")

RM 1,140

Cordless Angle Grinder
Pengisar Sudut Tanpa Kord
充电式角向磨光机



Top Slide Switch

Suis Gelangkar Atas 顶部滑动开关
Convenient for left & right handed
Mudah diguna dengan tangan
kiri atau kanan 方便左右手



- Spiral bevel gear for more efficient transfer of energy

Standard Equipment: Grinding Wheel (A-80656), Wheel Cover,
Side Grip, Lock Nut Wrench

• Z: Without Charger & Battery

BL MOTOR XPT ADT AFT

Wheel Diameter Diameter Roda 轮片直径	125mm (5")
No Load Speed (RPM) Kelajuan Tanpa Beban 回转数	3,000 - 8,500
Dimensions (L x W x H) Dimensi 体积	BL1850B: 382x140x145mm (15"x5-1/2"x5-3/4")
Net Weight Berat Bersih 净重	2.3 - 3.0kg (5.1 - 6.6lbs.)
Work Amount (approx.) Jumlah Kerja 工作量	13.8 m with BL1850B Cutting Concrete Depth 10mm

* All list price shown are for reference only (exclude SST).

* Semua harga yang ditunjukkan adalah untuk rujukan sahaja (tidak termasuk SST). 所有显示的建议零售价仅供参考 (不包括SST)。



Li-ion Ah 6.0 5.0 4.0 3.0 2.0 1.5

DGA514Z 125mm (5")
RM 1,675

Cordless Angle Grinder
Pengisar Sudut Tanpa Kord
充电式角向磨光机

Top Slide Switch

Suis Gelangsar Atas 顶部滑动开关
Convenient for left & right handed
Mudah diguna dengan tangan kiri atau kanan 方便左右手操作



- Auto-start Wireless System (AWS) connects to compatible vacuum cleaners with Bluetooth

Standard Equipment: Grinding Wheel (A-80656), Wheel Cover, Side Grip, Lock Nut Wrench

- Z: Without Charger & Battery



Wheel Diameter Diameter Roda 轮片直径	125mm (5")
No Load Speed (RPM) Kelajuan Tanpa Beban 回转数	3,000 - 8,500
Dimensions (L x W x H) Dimensi 体积	BL1850B: 382x140x151mm (15"x5-1/2"x5-15/16")
Net Weight Berat Bersih 淨重	2.4 - 3.0kg (5.2 - 6.7lbs.)
Work Amount (approx.) Jumlah Kerja 工作量	13.8 m with BL1850B Cutting Concrete Depth 10mm

DGA518Z 125mm (5")
RM 1,747

Cordless Angle Grinder
Pengisar Sudut Tanpa Kord
充电式角向磨光机

Paddle Switch

Suis Pemacu 扳机开关



- Auto-start Wireless System (AWS) connects to compatible vacuum cleaners with Bluetooth

Standard Equipment: Grinding Wheel (A-80656), Wheel Cover, Side Grip, Lock Nut Wrench

- Z: Without Charger & Battery



Wheel Diameter Diameter Roda 轮片直径	125mm (5")
No Load Speed (RPM) Kelajuan Tanpa Beban 回转数	3,000 - 8,500
Dimensions (L x W x H) Dimensi 体积	BL1850B: 382x140x151mm (15"x5-1/2"x6")
Net Weight Berat Bersih 淨重	2.4 - 3.1kg (5.3 - 6.8lbs.)
Work Amount (approx.) Jumlah Kerja 工作量	13.8 m with BL1850B Cutting Concrete Depth 10mm

DGA508RFE | **DGA508Z** 125mm (5")
RM 2,113 | RM 1,138

Cordless Angle Grinder
Pengisar Sudut Tanpa Kord
充电式角向磨光机

Paddle Switch

Suis Pemacu 扳机开关



- Electric brake for increased operator safety

Standard Equipment: Grinding Wheel (A-80656), Wheel Cover, Side Handle, Lock Nut Wrench

- RFE: 1x Rapid Charger, 2x 3.0Ah Battery
- Z: Without Charger, Battery & Carrying Case



Wheel Diameter Diameter Roda 轮片直径	125mm (5")
No Load Speed (RPM) Kelajuan Tanpa Beban 回转数	8,500
Dimensions (L x W x H) Dimensi 体积	362x140x151mm (14-1/4"x5-1/2"x5-15/16")
Net weight Berat Bersih 淨重	2.35 - 3.83kg (5.18 - 8.45lbs)
Work Amount (approx.) Jumlah Kerja 工作量	13.8 m with BL1850B Cutting Concrete Depth 10mm

DGA505RFE | **DGA505Z** 125mm (5")
RM 2,008 | RM 1,033

Cordless Angle Grinder
Pengisar Sudut Tanpa Kord
充电式角向磨光机

Paddle Switch

Suis Pemacu 扳机开关



- Efficient internal cooling for optimum performance

Standard Equipment: Grinding Wheel (A-80656), Wheel Cover, Side Handle, Lock Nut Wrench

- RFE: 1x Rapid Charger, 2x 3.0Ah Battery
- Z: Without Charger, Battery & Carrying Case



Wheel Diameter Diameter Roda 轮片直径	125mm (5")
No Load Speed (RPM) Kelajuan Tanpa Beban 回转数	8,500
Dimensions (L x W x H) Dimensi 体积	362x140x145mm (14-1/4"x5-1/2"x5-3/4")
Net weight Berat Bersih 淨重	2.26 - 3.73kg (4.98 - 8.23lbs)
Work Amount (approx.) Jumlah Kerja 工作量	13.8 m with BL1850B Cutting Concrete Depth 10mm

Model No. 型号			No Load Speed (rpm) Kelajuan Tanpa Beban 回转数	Switch Suis 开关	BL MOTOR	AFT	ADT	BRAKE	AWS	Anti-restart function Fungsi restart semula 防重启功能	XLOCK
100mm	115mm	125mm									
DGA414	-	DGA514	3,000 - 8,500	Slide	•	•	•	•	•	•	
DGA411	-	DGA511	3,000 - 8,500	Slide	•	•	•			•	
DGA406	DGA456	-	8,500	Slide	•	•	•	•		•	
DGA404	-	-	8,500	Slide	•	•	•			•	
DGA402	DGA452	-	11,000	Slide						•	
DGA419	-	DGA519	3,000 - 8,500	Paddle	•	•	•	•		•	•
DGA418	-	DGA518	3,000 - 8,500	Paddle	•	•	•	•	•	•	
DGA405	-	DGA505	8,500	Paddle	•	•	•			•	
DGA408	DGA458	DGA508	8,500	Paddle	•	•	•	•		•	

* All list price shown are for reference only (exclude SST).

* Semua harga yang ditunjukkan adalah untuk rujukan sahaja (tidak termasuk SST). 所有显示的建议零售价仅供参考 (不包括SST)。

Cordless
Target Kuching
LED Flashlight
Lampu Cahaya LED
1500000
Vacuum Cleaner
Penyedut Vakum
BLUET
Drilling / Fastening
Drool / Pasang
M10 / 1/2"
Impact Drilling / Demolition
Drool / Demoli
5/8" 1/2"
Cutting
Pemotong
1/2"
Grinding / Sanding
Pengisar / Pasang
2 1/2" / 3/4"
Sawing
Gergaji
1/2"
Planing / Routing
Pengisar / Pasang
M10 / 1/2"
Others
Lain-lain
Outdoor Power Equipment
Alat Kuasa Luar
M10-7/8"
Makita



Li-ion Ah 6.0 5.0 4.0 3.0 2.0 1.5

DGD800Z

RM 608

Cordless Die Grinder

Pengisar Tanpa Kord
充电式刻磨机



- Slide switch with lock-on for operator convenience



Standard Equipment: Wrench x2

• Z: Without Charger & Battery

DGD801Z

RM 608

Cordless Die Grinder

Pengisar Tanpa Kord
充电式刻磨机



- Round collet nut reduces the risk of damages



Standard Equipment: Wrench x2

• Z: Without Charger & Battery

DPO600Z

RM 2,528

DPO500Z

RM 2,515

Cordless Random Orbit Polisher

Pelicin Orbit Tanpa Kord
充电式砂光机



- Selectable two rotation mode: normal mode & finishing mode



Standard Equipment: Hex Wrench

• Z: Without Charger & Battery



VIDEO CLIP
Models and specs may vary by country

DPV300Z

RM 1,568

Cordless Sander Polisher

Pengilap Tanpa Kord
充电式打蜡抛光机



- Electronic speed control maintains constant speed under load, critical for a professional finish



Standard Equipment: Side Grip, Pad, Adapter, Wool Pad, Sponge Pad

• Z: Without Charger & Battery



DBS180Z

9mm x 533mm (3/8" x 21")

RM 1,950

Cordless Belt Sander

Pelicin Pita Tanpa Kord
充电式带式砂光机



- High power BL motor provides high performance



Standard Equipment: Sanding Belt, Grip, Grip Base

• Z: Without Charger & Battery



Capacity Kapasiti 能力	Collet : 3mm - 8mm
Wheel Diameter Diameter Roda 轮片直径	38mm (1-1/2")
No Load Speed (RPM) Kelajuan Tanpa Beban 回转数	26,000
Dimensions (L x W x H) Dimensi 体积	402x82x118mm (15-3/4"x3-1/4"x4-5/8")
Net Weight Berat Bersih 净重	1.7 - 2.2kg (3.8 - 4.9lbs)
Work Amount (approx.) Jumlah Kerja 工作量	9.0 g with BL1850B Grinding Steel Plate SS400

Capacity Kapasiti 能力	Collet : 3mm - 8mm
Wheel Diameter Diameter Roda 轮片直径	38mm (1-1/2")
No Load Speed (RPM) Kelajuan Tanpa Beban 回转数	25,000
Dimensions (L x W x H) Dimensi 体积	307x82x118mm (12-1/8"x3-1/4"x4-5/8")
Net Weight Berat Bersih 净重	1.5 - 2.0kg (3.3 - 4.3lbs)
Work Amount (approx.) Jumlah Kerja 工作量	9.5 g with BL1850B Grinding Steel Plate SS400

Pad Size Saiz Pad 垫子尺寸	150mm (6") DPO600 125mm (5") DPO500
Orbits Per Minute (OPM) Bilangan Putaran 轨道转速	Normal mode: 0 - 6,800 Finishing mode: 0 - 5,200
Strokes Per Minute (SPM) Kelajuan Strok 冲程速度	Normal mode: 0 - 13,600 Finishing mode: 0 - 10,400
No Load Speed (RPM) Kelajuan Tanpa Beban 回转数	Normal mode: 0 - 780 Finishing mode: 0 - 600
Orbit Diameter Kelajuan Tanpa Beban 回转数	5.5mm (7/32")
Dimensions (L x W x H) Dimensi 体积	530x148x126mm DPO600 (20-7/8"x5-7/8"x5") 530x123x134mm DPO500 (20-7/8"x4-7/8"x5-1/4")
Net Weight Berat Bersih 净重	3.1 - 3.6kg (6.8 - 7.9lbs.)

Pad / Disc Diameter Diameter Pad / Cakera 垫/盘直径	Hook & Loop Style: 80mm (3-1/8") Twist-On / Twist-Off Style: 50mm (2")
Backing Pad Diameter Diameter Pad 衬垫直径	Hook & Loop Style: 75mm (2-15/16") Twist-On / Twist-Off Style: 46mm (1-13/16")
Head Length Panjang Kepala 头长度	127 mm (5")
No Load Speed (RPM) Kelajuan Tanpa Beban 回转数	Polishing: 0 - 2,800 Sanding: 0 - 9,500
Dimensions (L x W x H) Dimensi 体积	160x79x256mm (6-5/16"x3-1/8"x10-1/8")
Net Weight Berat Bersih 净重	2.0 - 2.6kg (4.4 - 5.7lbs.)
Continuous Usage Time (approx.) Masa Penggunaan Berterusan 连续使用时间	34min with BL1850B

Belt Width Lebar Pita 砂带宽度	6mm (1/4") 9mm (3/8") 13mm (1/2")
Belt Length Panjang Pita 砂带长度	533mm (21")
Belt Speed Kelajuan Pita 砂带速度	600 - 1,700 m/min
Dimensions (L x W x H) Dimensi 体积	500x96x116mm (19-3/4"x3-3/4"x4-9/16")
Net Weight Berat Bersih 净重	1.8 - 2.1kg (4.0 - 4.6lbs.)



VIDEO CLIP
Models and specs may vary by country

* All list price shown are for reference only (exclude SST).

* Semua harga yang ditunjukkan adalah untuk rujukan sahaja (tidak termasuk SST). 所有显示的建议零售价仅供参考 (不包括SST)。

Cordless
Tempa Apa Saja

LED Flashlight
Lampu Senter LED
- LED LIGHT -
- LED LIGHT -

Vacuum Cleaner
Penyedut Vakuum
- 2.5L -
- 2.5L -

Drilling / Fastening
Gergaji / Pengikat
- 1/2" - 1/2" -

Impact Drilling / Demolition
Gergaji / Pecah
- 1/2" - 1/2" -

Cutting / Finishing
Pemotong / Finishing
- 1/2" - 1/2" -

Grinding / Sanding
Pengilap / Sanding
- 1/2" - 1/2" -

Sanding
Gergaji
- 1/2" - 1/2" -

Planing / Routing
Pajuan / Tebang
- 1/2" - 1/2" -

Others
Lain-lain
- 1/2" - 1/2" -

Outdoor Power Equipment
Alatan Kuasa Luar
- 1/2" - 1/2" -

Thakita
- 1/2" - 1/2" -



Cordless Drywall Sander

Pelicin Drywall Tanpa Kord 充电式石膏板砂光机

Masa Penggunaan Berterusan
连续使用时间

Continuous Usage Time with BL1850B (Speed dial 3)

35min
(approx.)

AWS
Auto-start Wireless System

Sistem permulaan wayarless automatik
无线自动启动系统

Wireless unit is compatible with all supported tools
Unit wayarless serasi dengan semua alat yang disokong
无线设备与所有支持的工具兼容

The wireless activation function enables clean and comfortable operation. By connecting a supported tool to the cleaner, you can run the cleaner automatically along with the switch operation of the tool
Fungsi pengaktifan tanpa wayar membolehkan operasi yang bersih dan selesa. Dengan menyambungkan alat kuasa dengan pembersih, anda boleh menjalankan pembersihan secara automatik dengan operasi suis alat tersebut
无线启动无线系统透过蓝牙连接到吸尘器, 启动工具吸尘器将自动运行

Aluminum pipe
Paip aluminium 铝管

Variable speed control dial
1,000 - 1,800min⁻¹
Dail kawalan kelajuan ubah 变速控制拨盘

Length adjustable telescopic pipe from 1,100mm to 1,520mm
Pelarasan panjang paip teleskopik dari 1,100mm hingga 1,520mm
可调节伸缩管从1,100mm至1,520mm

Dust collecting brush
Berus mengumpul habuk 集尘刷

Roller
Roller 滚轴

Accessories (Optional)
Aksesoris 配件

Pad		Abrasive disc 225	
Type	Part No.	Grit	Part No.
Soft	199939-3	40	B-68389
Medium	199940-8	80	B-68395
Hard	199938-5	120	B-68404
		180	B-68410
		320	B-68426



Tool length adjustable for various jobsites
Panjang alat boleh laras untuk pelbagai kerja
工具长度可调节适用于各种工作

DSL800Z 225mm (8-7/8")
RM 5,407

Cordless Drywall Sander
Pelicin Drywall Tanpa Kord
充电式石膏板砂光机

- Easy handling by cordless

Standard Equipment: Abrasive Disc, Hex Wrench, Tool Bag

• Z: Without Charger & Battery

BL MOTOR **XPT** **AWS**

VIDEO CLIP
Models and specs may vary by country

Pad diameter Diameter Pad 垫片直径	210mm (8-1/4")
Abrasive Disc Size Saiz Cakera 磨盘尺寸	225mm (8-7/8")
No Load Speed (RPM) Kelajuan Tanpa Beban 回转数	1,000 - 1,800
Dimensions (L x W x H) Dimensi 体积	1,100-1,520x259x273mm (43-1/4"-59-3/4"x10-1/4"x10-3/4")
Net Weight Berat Bersih 净重	4.5 - 5.7kg (10.0 - 12.6lbs.)
Continuous Usage Time (approx.) Masa Penggunaan Berterusan 连续使用时间	35 min with BL1850B Speed Dial 3

DSL801Z 225mm (8-7/8")
RM 5,407

Cordless Drywall Sander
Pelicin Drywall Tanpa Kord
充电式石膏板砂光机

- Redesigned dust collection brush reduces dust leakage

Standard Equipment: 1pc Abrasive Disc #120, Hex Wrench, Tool Bag (195638-5)(without inner tray)

• Z: Without Charger & Battery

BL MOTOR **XPT** **AWS**

NEW BARU 1/新

Pad diameter Diameter Pad 垫片直径	210mm (8-1/4")
Abrasive Disc Size Saiz Cakera 磨盘尺寸	225mm (8-7/8")
No Load Speed (RPM) Kelajuan Tanpa Beban 回转数	1,000 - 1,800
Dimensions (L x W x H) Dimensi 体积	1,100-1,520x259x273mm (43-1/4"-59-3/4"x10-1/4"x10-3/4")
Net Weight Berat Bersih 净重	4.5 - 5.7kg (10.0 - 12.6lbs.)
Continuous Usage Time (approx.) Masa Penggunaan Berterusan 连续使用时间	35 min with BL1850B Speed Dial 3

* All list price shown are for reference only (exclude SST).
* Semua harga yang ditunjukkan adalah untuk rujukan sahaja (tidak termasuk SST). 所有显示的建议零售价仅供参考 (不包括SST)。

18V

LXT

Li-ion Ah 6.0 5.0 4.0 3.0 2.0 1.5

Cordless Multi Tool

Pemotong dan Pengisar Pelbagai Fungsi Tanpa Kord 充电式多功能切割打磨机

*Jumlah Kerja 工作量
Work Amount
 with BL1860B
 (38mm thick SPF)
320cuts
 (approx.)



Due to double housing
 Cengkerang berganda 双壳

Cushion
 Kusyen 垫子

Anti-vibration damper
 Penyerap kejutan 减振器



Compatible with dust attachment for use with Sanding pad

Sesuai dengan aksesori tahan debu, boleh digunakan dengan pengamplasan 与防尘附件兼容, 可与打磨垫一起使用

-  **STARLOCK**
-  **STARLOCK PLUS**
-  **STARLOCK MAX**



Cutting plasterboards



Wood flush cutting



Removal of window frame



Cutting metals



Cutting PVC, FRP pipes



Routing joints on wall tiles



Copper pie flush cutting



Sanding and polishing

DTM52RTJX1 Price TBA

DTM52Z Price TBA

Cordless Multi Tool

Pemotong dan Pengisar Pelbagai Fungsi Tanpa Kord
 充电式多功能切割打磨机



- Compatible with STARLOCK / STARLOCK PLUS / STARLOCK MAX

Standard Equipment: Oscillating Multi Tool Accessories, Dust Attachment (country-specific), Tool Box (country-specific)

- RTJX1: 0x Rapid Charger, 0x 5.0Ah Battery
- Z: Without Charger, Battery & Carrying Case



*Not applicable for Z model



Oscillations Per Minute (OPM) Kelajuan Ayunan 摆动速度	10,000 - 20,000
Oscillation Angle Sudut Ayunan 摆动角度	Left: 1.8° Right: 1.8° Total: 3.6°
Shank Type Jenis Shank 刀柄类型	Multi Tool: STARLOCK MAX
Dimensions (L x W x H) Dimensi 体积	322 x 95 x 126 mm (12-5/8 x 3-3/4 x 5")
Net Weight Berat Bersih 净重	1.7 - 2.0 kg (3.7 - 4.4 lbs.)
Work Amount (approx.) Jumlah Kerja 工作量	320 cuts with BL1860B 38mm thick SPF

* All list price shown are for reference only (exclude SST).

* Semua harga yang ditunjukkan adalah untuk rujukan sahaja (tidak termasuk SST). 所有显示的建议零售价仅供参考 (不包括SST)。

Cordless
Tempa Masa Lebih

LED Flashlight
Lampu Sinar LED
- LED BRIGHT

Vacuum Cleaner
Penarik Debu
- 2.5L

Drilling / Fastening
Gali / Pasang
- 1/4" / 3/16"

Impact Drilling / Demolition
Gali / Pecah
- 1/2" / 3/8"

Cutting
Potong
- 1/4"

Grinding / Smoothing
Giling / Halus
- 1/4" / 3/8"

Sawing
Gali
- 1/4"

Planing / Routing
Polaris / Trogam
- 1/4" / 3/8"

Others
Lain-lain
- 1/4"

Outdoor Power Equipment
Alat Kuasa Luar
- 1/4"





Li-ion Ah 6.0 | 5.0 | 4.0 | 3.0 | 2.0 | 1.5

DTM51RFEX8 DTM51Z
RM 2,252 RM 1,163

Cordless Multi Tool
Pemotong dan Pengisar Pelbagai Fungsi Tanpa Kord
充电式多功能切割打磨机



- 12 Angle settings at every 30° from 0° to 360°

Standard Equipment:
DTM51RFEX8: Oscillating multi tool accessories, Tool Box

- RFEX8: 1x Rapid Charger, 2x 3.0Ah Battery
- Z: Without Charger, Battery & Carrying Case



Oscillations Per Minute (OPM) Kelajuan Ayunan 摆动速度	6,000 - 20,000
Oscillation Angle Sudut Ayunan 摆动角度	Left: 1.6° Right: 1.6° Total: 3.2°
Dimensions (L x W x H) Dimensi 体积	340x80x122mm (13-3/8"x3-1/8"x4-13/16")
Net Weight Berat Bersih 净重	2.0 - 2.4kg (4.4 - 5.3lbs)
Work Amount (approx.) Jumlah Kerja 工作量	40 pcs with BL1850B Cutting

DTM50Z
RM 987

Cordless Multi Tool
Pemotong dan Pengisar Pelbagai Fungsi Tanpa Kord
充电式多功能切割打磨机



- High operating efficiency

Standard Equipment: Hex Wrench

- Z: Without Charger & Battery



Oscillations Per Minute (OPM) Kelajuan Swing 摆动速度	6,000 - 20,000
Dimensions (L x W x H) Dimensi 体积	307x80x122mm (12-1/4"x3-1/8"x4-13/16")
Net Weight Berat Bersih 净重	1.8 - 2.2kg (3.9 - 4.8lbs)
Work Amount (approx.) Jumlah Kerja 工作量	35 pcs with BL1850B Cutting

DBO180Z 125mm (5")
RM 792

Cordless Random Orbit Sander
Pelicin Orbit Tanpa Kord
充电式砂光机



- Three speed control switch fast, medium and low

Standard Equipment: Abrasive Paper, Dust Bag

- Z: Without Charger & Battery



Pad Diameter Diameter Pad 垫片直径	123mm (4-7/8")
Abrasive Disc Size Saiz Cakera 磨盘尺寸	125mm (5")
Orbits Per Minute (OPM) Bilangan Putaran 轨道转速	7,000 9,500 11,000
Dimensions (L x W x H) Dimensi 体积	175x123x153mm (6-7/8"x4-7/8"x6")
Net Weight Berat Bersih 净重	1.4 - 1.7kg (3.0 - 3.7lbs)
Continuous Usage Time (approx.) Masa Penggunaan Berterusan 连续使用时间	66 min with BL1850B Low Speed Sanding

DLS600Z 165mm (6-1/2")
RM 4,407

Cordless Compound Miter Saw
Gergaji Kompaun Miter Tanpa Kord
充电式斜断锯



- High accuracy & Lightweight

Standard Equipment: TCT Saw Blade (B-56487), Dust Bag, Vertical Vise, Hex Wrench, Triangular Rule

- Z: Without Charger & Battery



Blade Diameter Diameter Bilah 锯片直径	165mm (6-1/2")
Miter Angle Sudut Miter 斜接角	52°L / 52°R
Bevel Angle Sudut Bevel 斜角	46°L / 46°R
Max Cutting Capacity Kapasiti Pemotongan Maksimum 最大切割能力	90° Miter: 46 x 92mm (1-13/16" x 3-5/8") 45° Miter, L/R: 46 x 65mm (1-13/16" x 2-9/16")
No Load Speed (RPM) Kelajuan Tanpa Beban 回转速数	5,000
Dimensions (L x W x H) Dimensi 体积	340x400x440mm (13-3/8"x15-3/4"x17-1/4")
Net Weight Berat Bersih 净重	6.3 - 6.6kg (13.9 - 14.6lbs)
Work Amount (approx.) Jumlah Kerja 工作量	625 pcs with BL1850B Sawing (Round Wood Height 15 x 90mm Thick)

DLS713RME DLS713Z 190mm (7-1/2")
RM 5,048 RM 3,908

Cordless Slide Compound Miter Saw
Gergaji Gelongsor Kompaun Miter Tanpa Kord
充电式斜断锯 (滑动复合式)



- Powerful Makita-built motor

Standard Equipment: TCT Saw Blade (A-86147), Vertical Vise, Socket Wrench, Triangular Rule, Dust Bag, Holder Set

- RME: 1x Rapid Charger, 2x 4.0Ah Battery
- Z: Without Charger & Battery



Blade Diameter Diameter Bilah 锯片直径	190mm (7-1/2")
Miter Angle Sudut Miter 斜接角	47°L / 57°R
Bevel Angle Sudut Bevel 斜角	45°L / 5°R
Max Cutting Capacity Kapasiti Pemotongan Maksimum 最大切割能力	90°: 52 x 300mm (2-1/16" x 11-3/4") 2,200
No Load Speed (RPM) Kelajuan Tanpa Beban 回转速数	2,200
Dimensions (L x W x H) Dimensi 体积	655x430x454mm (25-3/4"x17"x17-7/8")
Net Weight Berat Bersih 净重	12.1kg (26.7lbs)
Work Amount (approx.) Jumlah Kerja 工作量	300 pcs with BL1850B Sawing (Merbau Decking 90 x 19mm)

* All list price shown are for reference only (exclude SST).

* Semua harga yang ditunjukkan adalah untuk rujukan sahaja (tidak termasuk SST). 所有显示的建议零售价仅供参考 (不包括SST)。

Cordless
Terdapat dalam kategori
LED Flashlight
Lampu suluh LED
LED080807
Vacuum Cleaner
Penyedut habuk
VACUUM
Drilling / Fastening
Drool / Pengikat
M10 / M10
Impact Drilling / Demolition
Drool / Demolisi
Drool / 冲击钻
Cutting
Pemotongan
M10
Grinding / Sanding
Pengisar / Pasut
Drool / 可磨
Sawing
Drool
Drool
Planing / Routing
Pengisar / Rongkah
Drool / 刨
Outdoor Power Equipment
Alatan kuasa luar
Drool / 户外
Makita
Makita



Li-ion Ah 6.0 5.0 4.0 3.0 2.0 1.5

DHS661RFJ | **DHS661Z** 165mm (6-1/2")
 RM 2,798 | RM 1,823

Cordless Circular Saw
 Gergaji Piring Tanpa Kord
 充电式圆锯



- Compact and Lightweight Design for Better Maneuverability

Standard Equipment: TCT Saw Blade (B-63018), Hex Wrench, Rip Fence (Guide Rule), Dust Nozzle

- RFJ: 1x Rapid Charger, 2x 3.0Ah Battery, 1x Makpac Connector Box
- Z: Without Charger, Battery & Carrying Case

Icons: *Not applicable for Z model

Logos: **BL MOTOR**, **XPT**, **ADT**, **AWES**

Blade Diameter Diameter Bilah 锯片直径	165mm (6-1/2")
Hole Diameter Diameter Lubang 孔直径	15.88mm (5/8") 20mm (13/16")
Max Cutting Capacity Kapasiti Pemotongan Maksimum 最大切割能力	90°: 57mm (2-1/4") 45°: 41mm (1-5/8") 50°: 37mm (1-7/16")
No Load Speed (RPM) Kelajuan Tanpa Beban 回转数	5,000
Max Output Keluaran Maksima 最大输出	680W
Dimensions (L x W x H) Dimensi 体积	270x186x250mm (10-5/8"x7-3/8"x9-7/8")
Net Weight Berat Bersih 净重	2.9 - 3.2kg (6.4 - 7.1lbs.)
Work Amount (approx.) Jumlah Kerja 工作量	200 pcs with BL1850B Sawing with EFFICUT blade, 90° cut SPF 2 x 10 (Thickness 38mm, Width 89mm)

DHS680RMJ | **DHS680RFJ** | **DHS680Z** 165mm (6-1/2")
 RM 2,553 | RM 2,390 | RM 1,415

Cordless Circular Saw
 Gergaji Piring Tanpa Kord
 充电式圆锯



- High-efficiency BL motor provides higher power

Standard Equipment: TCT Saw Blade (B-63018), Hex Wrench, Rip Fence (Guide Rule)

- RMJ: 1x Rapid Charger, 2x 4.0Ah Battery, 1x Makpac Connector Box
- RFJ: 1x Rapid Charger, 2x 3.0Ah Battery, 1x Makpac Connector Box
- Z: Without Charger, Battery & Carrying Case

QR Code: DHS680

VIDEO CLIP
 Models and specs may vary by country

Icons: *Not applicable for Z model

Logos: **BL MOTOR**, **ADT**

Blade Diameter Diameter Bilah 锯片直径	165mm (6-1/2")
Max Cutting Capacity Kapasiti Pemotongan Maksimum 最大切割能力	90°: 57mm (2-1/4") 45°: 41mm (1-5/8") 50°: 37mm (1-7/16")
No Load Speed (RPM) Kelajuan Tanpa Beban 回转数	5,000
Dimensions (L x W x H) Dimensi 体积	350x170x238mm (13-3/4"x6-11/16"x9-3/8")
Net weight Berat Bersih 净重	3.0 - 3.3kg (6.6 - 7.3lbs)
Work Amount (approx.) Jumlah Kerja 工作量	170 pcs with BL1850B Sawing with Standard Blade, 90° cut SPF 2 x 10 (Thickness 38mm, Width 89mm)

DHS630RME | **DHS630RFE** | **DHS630Z** 165mm (6-1/2")
 RM 3,785 | RM 3,620 | RM 2,645

Cordless Circular Saw
 Gergaji Piring Tanpa Kord
 充电式圆锯



- Cut up to 66mm thick wood with a single stroke

Standard Equipment: TCT Saw Blade (D-51079), Hex Wrench, Rip Fence (Guide Rule)

- RME: 1x Rapid Charger, 2x 4.0Ah Battery
- RFE: 1x Rapid Charger, 2x 3.0Ah Battery
- Z: Without Charger, Battery & Carrying Case

Icons: *Not applicable for Z model

Logos: **BL MOTOR**, **ADT**

Blade Diameter Diameter Bilah 锯片直径	165mm (6-1/2")
Max Cutting Capacity Kapasiti Pemotongan Maksimum 最大切割能力	90°: 66mm (2-5/8") 45°: 46mm (1-13/16")
No Load Speed (RPM) Kelajuan Tanpa Beban 回转数	3,100
Dimensions (L x W x H) Dimensi 体积	346x220x247mm (13-5/8"x8-5/8"x9-3/4")
Net weight Berat Bersih 净重	3.0 - 3.4kg (6.6 - 7.5lbs)
Work Amount (approx.) Jumlah Kerja 工作量	260 pcs with BL1850B Sawing (Mixed Wood 2" x 2")

DSS610Z 165mm (6-1/2")
 RM 943

Cordless Circular Saw
 Gergaji Piring Tanpa Kord
 充电式圆锯



- Built-in dust blower directs sawdust away from cutting line

Standard Equipment: Carbide-Tipped Saw Blade, Rip Fence (Guide Rule), Hex Wrench

- Z: Without Charger & Battery



Icons:

Logos: **BL MOTOR**, **ADT**

Blade Diameter Diameter Bilah 锯片直径	165mm (6-1/2")
Max Cutting Capacity Kapasiti Pemotongan Maksimum 最大切割能力	90°: 0-57mm (2-1/4")/ 45°: 0-40mm (1-9/16") 50°: 0-36mm (1-7/16")
No Load Speed (RPM) Kelajuan Tanpa Beban 回转数	3,700
Dimensions (L x W x H) Dimensi 体积	347x202x228mm (13-5/8"x8"x9")
Net weight Berat Bersih 净重	3.0 - 3.4kg (6.7 - 7.5lbs)
Work Amount (approx.) Jumlah Kerja 工作量	230 pcs with BL1850B Sawing (Mixed Wood 2" x 2")

DSS501Z 136mm (5-3/8")
 RM 908

Cordless Circular Saw
 Gergaji Piring Tanpa Kord
 充电式圆锯

- Compact and lightweight design

Standard Equipment: Carbide-Tipped Saw Blade, Hex Wrench, Rip Fence (Guide Rule)

- Z: Without Charger & Battery

Icons:

Logos: **BL MOTOR**, **ADT**

Blade Diameter Diameter Bilah 锯片直径	136mm (5-3/8")
Max Cutting Capacity Kapasiti Pemotongan Maksimum 最大切割能力	90°: 51mm (2") 45°: 35mm (1-3/8")
No Load Speed (RPM) Kelajuan Tanpa Beban 回转数	3,600
Dimensions (L x W x H) Dimensi 体积	364x183x201mm (14-3/8"x7-1/4"x7-7/8")
Net Weight Berat Bersih 净重	2.4 - 2.7kg (5.3 - 6.0lbs)
Work Amount (approx.) Jumlah Kerja 工作量	230 pcs with BL1850B Sawing (Mixed Wood 2" x 2")

* All list price shown are for reference only (exclude SST).

* Semua harga yang ditunjukkan adalah untuk rujukan sahaja (tidak termasuk SST). 所有显示的建议零售价仅供参考 (不包括SST)。

Cordless
Tempat Kerja Tanpa Kord

LED Flashlight
Lampu Senter LED

Vacuum Cleaner
Penyedut Debu

Drilling / Fastening
Gergaji / Pengikat

Impact Drilling / Demolition
Gergaji / Pencah

Cutting
Memotong

Grinding / Sanding
Gergaji / Mengkilap

Sawing
Gergaji

Planing / Routing
Pajangan / Tugasan

Others
Lain-lain

Outdoor Power Equipment
Alatan Kuasa Luar





DJR187RME | **DJR187RFE** | **DJR187Z**
 RM 2,302 | RM 2,138 | RM 1,163

Cordless Recipro Saw
 Gergaji Resipro Tanpa Kord
 充电式往复锯

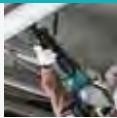

- BL Brushless DC motor with high power

Standard Equipment: Recipro Saw Blades 2pcs (B-05175 & B-05169)

- RME: 1x Rapid Charger, 2x 4.0Ah Battery
- RFE: 1x Rapid Charger, 2x 3.0Ah Battery
- Z: Without Charger, Battery & Carrying Case

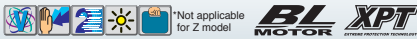

Length of Stroke Panjang Strok 冲程长度	32mm (1-1/4")
Strokes Per Minute (SPM) Kelajuan Strok 冲程速度	High: 0 - 3,000 Low: 0 - 2,300
Capacity Kapasiti 能力	Pipe: 130mm (5-1/8") Wood: 255mm (10")
Dimensions (L x W x H) Dimensi 体积	439x83x231mm (17-1/4"x3-1/4"x9-1/8")
Net Weight Berat Bersih 淨重	3.4 - 3.8kg (7.6 - 8.3lbs)
Work Amount (approx.) Jumlah Kerja 工作量	65 pcs with BL1850B Cutting (Steel Pipe Ø34 x 3mm)

DJR188Z
 RM 1,050

Cordless Recipro Saw
 Gergaji Resipro Tanpa Kord
 充电式往复锯



- High cutting speed (Max 3,000 SPM) provide higher cutting efficiency

Standard Equipment:
 Recipro Saw Blades 2pcs (B-20432 & B-20404)

- Z: Without Charger & Battery



Length of Stroke Panjang Strok 冲程长度	20mm (13/16")
Strokes Per Minute (SPM) Kelajuan Strok 冲程速度	0 - 3,000
Capacity Kapasiti 能力	Pipe : 130mm (5-1/8") Wood: 255mm (10")
Dimensions (L x W x H) Dimensi 体积	BL1815N: 316x81x203mm (12-1/2"x3-3/16"x8") BL1850B: 316x81x220mm (12-1/2"x3-3/16"x8-5/8")
Net Weight Berat Bersih 淨重	2.6 - 2.9kg (5.7 - 6.4lbs)
Work Amount (approx.) Jumlah Kerja 工作量	58 pcs with BL1850B Cutting (Steel Pipe Ø34 x 3mm)

DJR186RME | **DJR186RFE** | **DJR186Z**
 RM 2,043 | RM 1,880 | RM 905

Cordless Recipro Saw
 Gergaji Resipro Tanpa Kord
 充电式往复锯



- Toolless blade change; redesign of blade clamp makes it easier to remove a blade

Standard Equipment:
 Recipro Saw Blades 2pcs (B-05175 & B-05169)

- RME: 1x Rapid Charger, 2x 4.0Ah Battery
- RFE: 1x Rapid Charger, 2x 3.0Ah Battery
- Z: Without Charger, Battery & Carrying Case

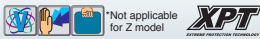

Length of Stroke Panjang Strok 冲程长度	32mm (1-1/4")
Strokes Per Minute (SPM) Kelajuan Strok 冲程速度	0 - 2,800
Capacity Kapasiti 能力	Pipe : 130mm (5-1/8") Wood: 255mm (10")
Dimensions (L x W x H) Dimensi 体积	486x81x223mm (19-1/8"x3-3/16"x8-3/4")
Net Weight Berat Bersih 淨重	3.5 - 3.8kg (7.6 - 8.3lbs)
Work Amount (approx.) Jumlah Kerja 工作量	60 pcs with BL1850B Cutting (Steel Pipe Ø34 x 3mm)

DJR181RFE
 RM 1,853

Cordless Recipro Saw
 Gergaji Resipro Tanpa Kord
 充电式往复锯

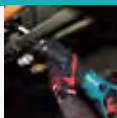

- Toolless blade change system enables fast, one-handed blade changes

Standard Equipment: Recipro Saw Blade

- RFE: 1x Rapid Charger, 2x 3.0Ah Battery



Length of Stroke Panjang Strok 冲程长度	28mm (1-1/8")
Strokes Per Minute (SPM) Kelajuan Strok 冲程速度	0 - 2,900
Capacity Kapasiti 能力	Pipe : 130mm (5-1/8") Wood: 255mm (10")
Dimensions (L x W x H) Dimensi 体积	499x91x234mm (19-5/8"x3-5/8"x9-1/4")
Net Weight Berat Bersih 淨重	3.5kg (7.7lbs)
Work Amount (approx.) Jumlah Kerja 工作量	70 pcs with BL1850B Cutting (SPF Material 2x10")

DJR183Z
 RM 952

Cordless Recipro Saw
 Gergaji Resipro Tanpa Kord
 充电式往复锯



- Dual-position on/off switch allows for either paddle or trigger switch operation

Standard Equipment: Recipro Saw Blades 2pcs

- Z: Without Charger & Battery



Capacity Panjang Strok 冲程长度	Pipe : 50mm (2") Wood: 50mm (2")
Length of Stroke Kelajuan Strok 冲程速度	13mm (1/2")
Strokes Per Minute (SPM) Kapasiti 能力	0-3,000
Dimensions (L x W x H) Dimensi 体积	392x81x209mm (15-1/2"x3-3/16"x8-1/4")
Net weight Berat Bersih 淨重	1.5 - 1.7kg (3.3 - 3.8lbs)
Work Amount (approx.) Jumlah Kerja 工作量	56 pcs with BL1850B Cutting (SPF Material 2x10")

* All list price shown are for reference only (exclude SST).

* Semua harga yang ditunjukkan adalah untuk rujukan sahaja (tidak termasuk SST). 所有显示的建议零售价仅供参考 (不包括SST)。

Cordless
 LED Flashlight
 Vacuum Cleaner
 Drilling / Fastening
 Impact Drilling / Demolition
 Cutting / Penetrating
 Grinding / Sanding
 Sawing
 Planing / Routing
 Drivers
 Outdoor Power Equipment





Li-ion Ah 6.0 5.0 4.0 3.0 2.0 1.5

DJV182RME RM 2,615	DJV182RFE RM 2,452	DJV182Z RM 1,477
------------------------------	------------------------------	----------------------------

Cordless Jig Saw
Gergaji Jig Tanpa Kord
充电式线锯机



- Powerful Brushless DC motor

Standard Equipment: Jig Saw Blade Set (No. BR-10, BR-13, B-22, 2pcs each), Cover Plate, Anti-Splintering Device, Hex Wrench

- RME: 1x Rapid Charger, 2x 4.0Ah Battery
- RFE: 1x Rapid Charger, 2x 3.0Ah Battery
- Z: Without Charger, Battery & Carrying Case

VIDEO CLIP
Models and specs may vary by country

BL MOTOR

Capacity Kapasiti 能力	Wood: 135mm (5-5/16") Steel: 10mm (3/8")
Length of Stroke Panjang Strok 冲程长度	26mm (1")
Strokes Per Minute (SPM) Kelajuan Strok 冲程速度	800 - 3,500
Dimensions (L x W x H) Dimensi 体积	266x77x208mm (10-1/2"x3"x8-3/16")
Net Weight Berat Bersih 净重	2.4 - 2.7kg (5.2 - 5.9lbs)
Work Amount (approx.) Jumlah Kerja 工作量	266 pcs with BL1850B Sawing with Blade B-10 Plywood (Thickness 12mm x Length 300mm)

DJV181RFE RM 2,452	DJV181Z RM 1,477
------------------------------	----------------------------

Cordless Jig Saw
Gergaji Jig Tanpa Kord
充电式线锯机



- Excellent performance provides higher productivity

Standard Equipment: Jig Saw Blade Set (No. BR-10, BR-13, B-22, 2pcs each), Cover Plate, Anti-Splintering Device, Hex Wrench

- RFE: 1x Rapid Charger, 2x 3.0Ah Battery
- Z: Without Charger, Battery & Carrying Case

VIDEO CLIP
Models and specs may vary by country

BL MOTOR

Capacity Kapasiti 能力	Wood: 135mm (5-5/16") Steel: 10mm (3/8")
Length of Stroke Panjang Strok 冲程长度	26mm (1")
Strokes Per Minute (SPM) Kelajuan Strok 冲程速度	800 - 3,500
Dimensions (L x W x H) Dimensi 体积	298x77x189mm (11-3/4"x3"x7-7/16")
Net Weight Berat Bersih 净重	2.3 - 2.6kg (5.0 - 5.7lbs)
Work Amount (approx.) Jumlah Kerja 工作量	266 pcs with BL1850B Sawing with Blade B-10 Plywood (Thickness 12mm x Length 300mm)

DJV180RFE RM 2,188	DJV180Z RM 1,212	440
------------------------------	----------------------------	-----

Cordless Jig Saw
Gergaji Jig Tanpa Kord
充电式线锯机



- Low vibration and low noise

Standard Equipment: Jig Saw Blade Set (No. BR-10, BR-13, B-22, 2pcs each), Cover Plate, Anti-Splintering Device, Hex Wrench

- RFE: 1x Rapid Charger, 2x 3.0Ah Battery
- Z: Without Charger, Battery & Carrying Case



VIDEO CLIP
Models and specs may vary by country

BL MOTOR

Capacity Kapasiti 能力	Wood: 135mm (5-5/16") Steel: 10mm (3/8")
Length of Stroke Panjang Strok 冲程长度	26mm (1")
Strokes Per Minute (SPM) Kelajuan Strok 冲程速度	0-2,600
Dimensions (L x W x H) Dimensi 体积	257x73x208mm (10-1/8"x2-7/8"x8-3/16")
Net Weight Berat Bersih 净重	2.7 - 3.0kg (6.0 - 6.7lbs)
Work Amount (approx.) Jumlah Kerja 工作量	216 pcs with BL1850B Sawing with Blade B-10 Plywood (Thickness 12mm x Length 300mm)

DSD180Z
RM 1,468

Cordless Drywall Saw
Gergaji Drywall Tanpa Kord
充电式石膏板切割机

- Ideal for cutting holes in drywalls when setting ceiling lights, air vents etc

Standard Equipment: Blade, Blade Cover, Base Cover, Hex Wrench

- Z: Without Charger & Battery

VIDEO CLIP
Models and specs may vary by country

BL MOTOR

Strokes Per Minute (SPM) Kelajuan Strok 冲程速度	0 - 6,000
Length of Stroke Panjang Strok 冲程长度	6mm (1/4")
Capacity Kapasiti 能力	Drywall: 30mm (1-3/16") Wood: 15mm (9/16")
Dimensions (L x W x H) Dimensi 体积	263x79x291mm (10-3/8"x3-1/8"x11-3/8")
Net weight Berat Bersih 净重	1.7 - 2.0kg (3.8 - 4.5lbs)
Work Amount (approx.) Jumlah Kerja 工作量	360 m with BL1850B Cutting (Gypsum Board Thickness 12.5mm/1ply)

DPJ180Z RM 1,232	430
----------------------------	-----

Cordless Plate Joiner
Mesin Kayu Tanpa Kord
充电式木工接合机

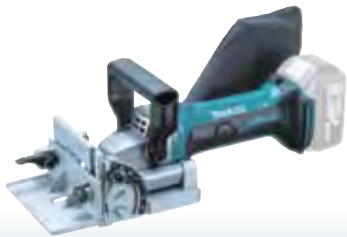
- Easy blade setting system for fast blade installation

Standard Equipment: Cutter Blade, Angle Guide, Lock Nut Wrench, Set Plate, Dust Bag

- Z: Without Charger & Battery

BL MOTOR

Blade Diameter Diameter Bilah 锯片直径	100mm (4")
Max Cutting Depth Kedalaman Pemotongan Maksimum 最大切割深度	20mm (3/4")
No Load Speed (RPM) Kelajuan Tanpa Beban 回转数	6,500
Dimensions (L x W x H) Dimensi 体积	351x139x149mm (13-3/4"x5-1/2"x5-7/8")
Net weight Berat Bersih 净重	2.8 - 3.1kg (6.2 - 6.8lbs)
Work Amount (approx.) Jumlah Kerja 工作量	333 pcs with BL1850B Biscuit (60 x 23 x 4) Cutting Slot 12.3mm

* All list price shown are for reference only (exclude SST).
* Semua harga yang ditunjukkan adalah untuk rujukan sahaja (tidak termasuk SST). 所有显示的建议零售价仅供参考 (不包括SST)。

Cordless
Tempa Tanpa Kord

LED Flashlight
Lampu Senter LED

Vacuum Cleaner
Penyedut Hava

Drilling / Fastening
Gergaji / Pasak

Impact Drilling / Demolition
Gergaji / Pecah

Cutting / Trimming
Potong / Hiris

Grinding / Smoothing
Gergaji / Rata

Sawing
Gergaji

Planing / Routing
Gergaji / Trogam

Others
Lain-lain

Outdoor Power Equipment
Alatan Kuasa Luar

Thakita
18V

18V

LXT

Li-ion Ah 6.0 | 5.0 | 4.0 | 3.0 | 2.0 | 1.5

DKP181RTJ | **DKP181Z** 82mm (3-1/4")
RM 3,425 | RM 2,140

Cordless Planer
Pengetam Tanpa Kord
充电式电刨

- Auto-start Wireless System (AWS) connects to vacuum cleaner with Bluetooth

Standard Equipment: Planer Blade, Blade Gauge, Guide Rule, Depth Guide, Socket Wrench, Sharpening Holder Assembly (for resharpenable blade)

- RTJ: 1x Rapid Charger, 2x 5.0Ah Battery, 1x Makpac Connector Box
- Z: Without Charger, Battery & Carrying Case



*Not applicable for Z model



Planing Width Lebar Pelan 刨削宽度	82mm (3-1/4")
Planing Depth Kedalaman Pelan 刨削深度	3mm (1/8")
No Load Speed (RPM) Kelajuan Tanpa Beban 回转数	12,000
Dimensions (L x W x H) Dimensi 体积	366x156x166mm (14-3/8"x6-1/8"x6-1/2")
Net Weight Berat Bersih 净重	3.3 - 3.6kg (7.3 - 7.9lbs.)
Work Amount (approx.) Jumlah Kerja 工作量	46 m with BL1850B 67mm wide x 1,000mm (Douglas fir) (depth 2.0mm)



DKP181

VIDEO CLIP
Models and specs may vary by country

DKP180RFE | **DKP180Z** 82mm (3-1/4")
RM 2,052 | RM 1,075

Cordless Planer
Pengetam Tanpa Kord
充电式电刨

- Easy blade setting system for fast blade installation

Standard Equipment: Planer Blade, Blade Gauge, Guide Rule, Socket Wrench

- RFE: 1x Rapid Charger, 2x 3.0Ah Battery
- Z: Without Charger, Battery & Carrying Case



*Not applicable for Z model



Planing Width Lebar Pelan 刨削宽度	82mm (3-1/4")
Planing Depth Kedalaman Pelan 刨削深度	2.0mm (5/64")
No Load Speed (RPM) Kelajuan Tanpa Beban 回转数	14,000
Dimensions (L x W x H) Dimensi 体积	333x157x160mm (13-1/8"x6-3/16"x6-5/16")
Net weight Berat Bersih 净重	3.2 - 3.5kg (7.1 - 7.9lbs)
Work Amount (approx.) Jumlah Kerja 工作量	91 m with BL1850B Wood Thickness 1mm

Cordless Grease Gun

Alat Tembak Gris Tanpa Kord 充电式黄油枪

Max Operating Pressure
Tekanan Beroperasi Maksimum
最大操作压力
69MPa



1.2m Flexible hose enables easy operation even in tight places

Hos fleksibel 1.2m dapat dikendalikan dengan mudah walaupun di tempat yang sempit
1.2m软管即使在狭窄的地方也可以轻松操作

Applicable Grease Type
Jenis gris yang sesuai 适用黄油黏度
NLGI No.0 - No.2

DGP180RT | **DGP180Z**
RM 2,307 | RM 1,495

Cordless Grease Gun
Alat Tembak Gris Tanpa Kord
充电式黄油枪

- Mainly for maintenance jobs of heavy machinery, farm machinery or other large machinery, such as greasing up, crawler track tensioning and more

Standard Equipment: Shoulder Strap

- RT: 1x Rapid Charger, 1x 5.0Ah Battery
- Z: Without Charger, Battery & Carrying Case



*Not applicable for Z model



Flow Rate Kadar Aliran 流量	Auto Speed Change Mode: 290mL/min (10.0oz/min) Slow Speed Mode: 145mL/min (5.0oz/min)
Grease Capacity w/ Barrel A	Cartridge: 410g (14.5oz) Bulk: 455g (16.0oz)
Grease Capacity w/ Barrel B	Cartridge: 450g (15.9oz) Bulk: 570g (20.1oz)
Grease Capacity w/ Barrel C	Cartridge: 500g (17.6oz) Bulk: 570g (20.1oz)
Kapasiti Gris 黄油容量	
Hose Length Panjang Hos 软管长度	120cm (47-1/4")
Max Operating Pressure Tekanan Beroperasi Maksimum 最大使用气压	69MPa (10000PSI)
Dimensions (L x W x H) Dimensi 体积	411x114x245mm (16-1/4x4-1/2x9-5/8")
Net Weight Berat Bersih 净重	4.8 - 6.1kg (10.6 - 13.4lbs.)
Work Amount (approx.) Jumlah Kerja 工作量	2,356mL Dispensing (Operating pressure 60MPa at low speed range)

* All list price shown are for reference only (exclude SST).

* Semua harga yang ditunjukkan adalah untuk rujukan sahaja (tidak termasuk SST). 所有显示的建议零售价仅供参考 (不包括SST)。

Cordless Impact Driver
LED Flashlight
Vacuum Cleaner
Drilling / Fastening
Impact Drilling / Demolition
Cutting
Grinding / Sanding
Sawing
Planing / Routing
Others
Outdoor Power Equipment



18V

LXT

Li-ion Ah 6.0 5.0 4.0 3.0 2.0 1.5

DCO181Z 6.35mm (1/4")
RM 1,540

Cordless Cut-Out Tool
Mesin Pemotong Tanpa Kord
充电式石膏板开孔机



- Auto-start Wireless System (AWS) connects to compatible vacuum cleaners with Bluetooth

Standard Equipment: Drywall Guide Bit x2, Collet Cone, Dust Collection Cover, Wrench

• Z: Without Charger & Battery



DCO181

VIDEO CLIP
Models and specs may vary by country

Collet Capacity Kapasiti Collet 夹头直径	3mm (1/8") 6mm(1/4")
No Load Speed (RPM) Kelajuan Tanpa Beban 回转数	32,000
Circumference of Grip Portion Lingkar Pemegang 握把周长	210mm (8-1/4")
Dimensions (L x W x H) Dimensi 体积	311x79x117mm (12-1/4x3-1/8x4-5/8")
Net Weight Berat Bersih 淨重	1.4 - 1.7kg (3.1 - 3.7lbs.)
Work Amount (approx.) Jumlah Kerja 工作量	Up to 32 cuts for a drywall of 1/2 inch (12.7mm) thickness with cutting length of 910mm using drywall guide tip bit 6.35mm with BL1830B

DCO180Z 6.35mm (1/4")
RM 662

Cordless Cut-Out Tool
Mesin Pemotong Tanpa Kord
充电式石膏板开孔机



- Accepts both 1/8" and 1/4" bits

Standard Equipment: Drywall Guide Bit x2, Collet Nut, Collet Cone 6.35mm (1/4")

• Z: Without Charger & Battery



430 W

Capacity Kapasiti 能力	Collet : 3.18mm (1/8") or 6.35mm (1/4") 30,000
No Load Speed (RPM) Kelajuan Tanpa Beban 回转数	296x77x118mm (11-5/8"x3"x4-5/8")
Dimensions (L x W x H) Dimensi 体积	1.5 - 1.8kg (3.3 - 4.0lbs)
Net weight Berat Bersih 淨重	225 m with BL1850B 6.35mm Bit Cutting Plaster Board 1.2 x 800mm
Work Amount (approx.) Jumlah Kerja 工作量	

DVP180Z
RM 2,632

Cordless Vacuum Pump
Pam Vakum Tanpa Kord
充电式真空泵



- For air purge during installation of room air conditioner

Standard Equipment: Vacuum Pump Oil, Adapter

• Z: Without Charger & Battery

Flow Rate Kadar Aliran 流量	50L/min
Ultimate Vacuum Tahap Maksimum Vakum 最大真空度	20Pa (150 microns)
Motor Speed Kelajuan Motor 马达速度	3,840min ⁻¹
Oil Tank Capacity Kapasiti Tangki Minyak 润滑油箱	115mL
Inlet Port Pelabuhan Inlet 进气管直径	5/16"
Dimensions (L x W x H) Dimensi 体积	265x93x175mm (10-3/8"x3-5/8"x6-7/8")
Net Weight Berat Bersih 淨重	3.5kg
Continuous Usage Time (approx.) Masa Penggunaan Berterusan 连续使用时间	50 min with BL1850B

DRT50Z | **DRT50ZJX9** 6mm (1/4"), 8mm (3/8")
RM 1,192 | RM 2,127

Cordless Trimmer
Mesin Perapi Tanpa Kord
充电式修边机



- Faster Trimming than Corded

Standard Equipment: Trimmer Base Assembly (196612-6), Collet Cone, Dust Nozzle, Straight Guide Assembly, Wrench x2

- Z : Without Charger, Battery & Carrying Case
- ZJX9 : Tilt Base Assembly (195561-4), Plunge Base Assembly (195563-0), Side Grip, Templet Guide, Guide Rail Adapter Set, Guide Holder Set, Makpac Connector Box, Without Charger & Battery

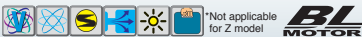

Trimmer Base Assembly
For DRT50ZJX9 only

Collet Capacity Kapasiti Collet 夹头直径	6mm, 8mm or 1/4", 3/8"
No Load Speed (RPM) Kelajuan Tanpa Beban 回转数	10,000 - 30,000
Plunge Capacity Kapasiti Plunge 能力	Trimmer Base: 0 - 40mm (0" - 1-9/16") Plunge Base: 0 - 35mm (0" - 1-3/8")
Dimensions (L x W x H) Dimensi 体积	134x89x226mm (5-1/4"x3-1/2"x8-7/8")
Net Weight Berat Bersih 淨重	1.8 - 2.1kg (3.9 - 4.6lbs)
Work Amount (approx.) Jumlah Kerja 工作量	83 m with BL1850B Routing Ø6 x 4mm

Trimmer Base Assembly (Optional)



Trimmer Base
Part No. 196612-6



Plunge Base
Part No. 195563-0
(Optional)



Tilt Base
Part No. 195561-4
(Optional)



Offset Base
Part No. 196922-1
(Optional)

* All list price shown are for reference only (exclude SST).

* Semua harga yang ditunjukkan adalah untuk rujukan sahaja (tidak termasuk SST). 所有显示的建议零售价仅供参考 (不包括SST)。

Cordless
Tempat Masa

LED Flashlight
Lampu Senter LED

Vacuum Cleaner
Penyedut Vakum

Drilling / Fastening
Galian / Pasang

Impact Drilling / Demolition
Galian / Pecah

Cutting
Memotong

Grinding / Smoothing
Mencik / Ratakan

Sawing
Gergaji

Planing / Routing
Papan / Tugam

Others
Lain-lain

Outdoor Power Equipment
Alatan Kuasa Luar

Makita
MAKITA



Li-ion Ah 6.0 5.0 4.0 3.0 2.0 1.5

DFN350Z

RM 3,672

Cordless Brad Nailer

Mesin Pemaku Tanpa Kord
充电式打钉机



- Ideal for Light Duty Applications such as Fastening Chamfer Strip to Concrete Form Plywood Wall

Standard Equipment: Safety Goggles, Nose Adapter, Hex Wrench, Belt Clip

• Z : Without Charger & Battery



Capacity Kapasiti 能力	Length: 15 - 35mm (5/8" - 1-3/8")
Magazine Capacity Bilangan Staples 装订个数	Gauge: 18Ga 110
Dimensions (L x W x H) Dimensi 体积	257x79x228mm (10-1/8"x3-1/8"x9")
Net Weight Berat Bersih 淨重	2.1 - 2.4kg (4.6 - 5.3lbs.)
Work Amount (approx.) Jumlah Kerja 工作量	4000pcs with BL1850B

Accessories (optional)			
Description	Size	Pcs/ Box	Part No.
Brad Nail 15mm (5/8")	F15	5,000	B-04307
Brad Nail 20mm (3/4")	F20	5,000	B-04313
Brad Nail 25mm (1")	F25	5,000	B-04329
Brad Nail 30mm (1-3/16")	F30	5,000	B-04335
Brad Nail 35mm (1-3/8")	F35	5,000	B-04357

DPT353Z

RM 2,560

Cordless Pin Nailer

Mesin Pemaku Tanpa Kord
充电式打钉机



- Shoots 6,400 nails on a single full BL1860B charge

Standard Equipment: Nose Adapter, Safety Goggles, Belt Clip

• Z : Without Charger & Battery



Capacity Staple 钉种	Length: 15, 18, 25, 30, 35mm (5/8", 11/16", 1", 1-3/16", 1-3/8")
Magazine Capacity Bilangan Staples 装订个数	Dia.: 0.6mm (1/32") Gauge: 23Ga 120
Dimensions (L x W x H) Dimensi 体积	257x79x226mm (10-1/8"x3-1/8"x8-7/8")
Net Weight Berat Bersih 淨重	2.0 - 2.3kg (4.4 - 5.1 lbs)
Work Amount (approx.) Jumlah Kerja 工作量	5300 pcs Pin Nail with BL1850B

Accessories (optional)			
Description	Size	Pcs/ Box	Part No.
Pin Nail 18mm (11/16")	P18	10,000	F-31825
Pin Nail 25mm (1")	P25	10,000	F-31838
Pin Nail 30mm (1-3/16")	P30	10,000	F-31841
Pin Nail 35mm (1-3/8")	P35	10,000	F-31854

DST121ZK

RM 2,917

Cordless Stapler

Stapler Tanpa Kord
充电式钉枪

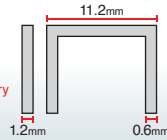

- Contact arm mechanism enables "continuous nailing" and "drag nailing"

Standard Equipment: Safety Goggles (195246-2), Nose Adapter, Belt Clip

• ZK: With Carrying Case, Without Charger & Battery

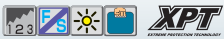

Staple Staple 钉种	Width: 10mm (3/8") Length: 13 - 25mm (1/2 - 1")
Magazine Capacity Bilangan Staples 装订个数	Size: 1.2 x 0.6mm 100
Dimensions (L x W x H) Dimensi 体积	260x79x216mm (10-1/4x3-1/8x8-1/2")
Net Weight Berat Bersih 淨重	2.2 - 2.5kg (4.9 - 5.5lbs.)
Work Amount (approx.) Jumlah Kerja 工作量	4000 pcs with BL1850B

Accessories (optional)		
Description	Length	Part No.
Staple 1010J	10mm	B-04466
Staple 1013J	13mm	B-04472
Staple 1016J	16mm	B-04488
Staple 1019J	19mm	B-04494
Staple 1022J	22mm	B-04503
Staple 1025J	25mm	B-04519

DST221Z

RM 1,983

Cordless Stapler

Stapler Tanpa Kord
充电式钉枪

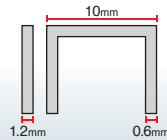

- Compact and powerful stapler can drive a wide range of 10mm staple lengths

Standard Equipment: Safety Goggles, Hook

• Z : Without Charger & Battery



Staple Staple 钉种	Width: 10mm (3/8") Length: 10, 13, 16, 19, 22mm (3/8", 1/2", 5/8", 3/4", 7/8")
Magazine Capacity Bilangan Staples 装订个数	Gauge: 0.6 x 1.2mm (1/32" x 1/16") 98
Dimensions (L x W x H) Dimensi 体积	251x91x212mm (9-7/8"x3-5/8"x8-3/8")
Net Weight Berat Bersih 淨重	2.1 - 2.4kg (4.7 - 5.3lbs)
Work Amount (approx.) Jumlah Kerja 工作量	3000 pcs with BL1850B Stapler Width 10mm

Accessories (optional)			
Description	Length	Pcs/ Box	Part No.
Staple 1010HD	10mm (3/8")	5,040	F-32647
Staple 1013HD	13mm (1/2")	5,040	F-32650
Staple 1016HD	16mm (5/8")	5,040	F-32663
Staple 1019HD	19mm (3/4")	5,040	F-32676
Staple 1022HD	22mm (7/8")	5,040	F-32689

DST421ZK

RM 2,917

Cordless Stapler

Stapler Tanpa Kord
充电式钉枪

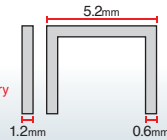

- Contact arm mechanism enables "continuous nailing" and "drag nailing"

Standard Equipment: Safety Goggles (195246-2), Nose Adapter, Belt Clip

• ZK: With Carrying Case, Without Charger & Battery



Staple Staple 钉种	Width: 4mm Length: 13 - 25mm (1/2 - 1")
Magazine Capacity Bilangan Staples 装订个数	Size: 1.2 x 0.6mm 100
Dimensions (L x W x H) Dimensi 体积	260x79x216mm (10-1/4x3-1/8x8-1/2")
Net Weight Berat Bersih 淨重	2.2 - 2.5kg (4.9 - 5.5lbs.)
Work Amount (approx.) Jumlah Kerja 工作量	4000 pcs with BL1850B

Accessories (optional)			
Description	Length	Part No.	
Staple 410J	10mm	B-04400	
Staple 413J	13mm	B-04416	
Staple 416J	16mm	B-04422	
Staple 419J	19mm	B-04438	
Staple 422J	22mm	B-04444	
Staple 425J	25mm	B-04450	

* All list price shown are for reference only (exclude SST).

* Semua harga yang ditunjukkan adalah untuk rujukan sahaja (tidak termasuk SST). 所有显示的建议零售价仅供参考 (不包括SST)。



Li-ion Ah 6.0 | 5.0 | 4.0 | 3.0 | 2.0 | 1.5

DUR192LST | DUR192LZ
RM 1,617 | RM 813

Cordless Grass Trimmer
Pemotong Rumput Tanpa Kord
充电式割草机

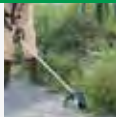

- Cost competitive model with increased output power

Standard Equipment: Nylon Cutting Head, Safety Goggles (195246-2), Band Assembly, Hex Wrench

- LST: 1x Standard Charger, 1x 5.0Ah Battery
- LZ: Without Charger & Battery



Cutting Width Lebar Keratan 切割宽度	Nylon Cutting Head: 300mm (11-3/4")
No Load Speed (RPM) Kelajuan Tanpa Beban 回转数	High: 0 - 4,500 Low: 0 - 6,000
Spindle Size Saiz Spinde 主轴尺寸	M10 x 1.25LH
Dimensions (L x W x H) Dimensi 体积	1,836x345x236mm (72-1/4x13-5/8x9-1/4")
Net Weight Berat Bersih 淨重	3.2 - 3.5kg (7.1 - 7.7lbs.)
Continuous Usage Time (approx.) Masa Penggunaan Berterusan 连续使用时间	High: 18 min Low: 34 min with BL1850B 300mm (11-3/4") Nylon Cutting Head

DUR191LRT2 | DUR191LZX2
RM 2,553 | RM 1,267

Cordless Grass Trimmer
Pemotong Rumput Tanpa Kord
充电式割草机



- Lightweight and powerful cutting performance

Standard Equipment: Plastic Blade, Safety Goggles (195246-2), Band Assembly, Accessory Bag, Hex Wrench

- LRT2: 1x Rapid Charger, 2x 5.0Ah Battery
- LZ2: Without Charger & Battery



Cutting Width Lebar Keratan 切割宽度	Nylon Cutting Head: 300mm (11-3/4") Metal Blade: 230mm (9") Plastic Blade: 255mm (10")
No Load Speed (RPM) Kelajuan Tanpa Beban 回转数	3,500 - 6,000
Spindle Size Saiz Spinde 主轴尺寸	M10 x 1.25LH
Dimensions (L x W x H) Dimensi 体积	1,836x345x236mm (72-1/4x13-5/8x9-1/4")
Net Weight Berat Bersih 淨重	3.2 - 3.5kg (7.1 - 7.7lbs.)
Continuous Usage Time (approx.) Masa Penggunaan Berterusan 连续使用时间	Low: 74 min with BL1860B Plastic blade with load

DUR190LRT2 | DUR190LZX2
RM 2,370 | RM 1,085

Cordless Grass Trimmer
Pemotong Rumput Tanpa Kord
充电式割草机

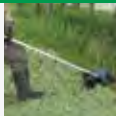

- Lightweight and powerful cutting performance

Standard Equipment: Plastic Blade (198384-9), Safety Goggles (195246-2), Band Assembly (125516-5), Accessory Bag, Hex Wrench

- LRT2: 1x Rapid Charger, 2x 5.0Ah Battery
- LZ2: Without Charger & Battery



Cutting Width Lebar Keratan 切割宽度	Nylon Cutting Head: 300mm (11-3/4") Metal Blade: 230mm (9") Plastic Blade: 255mm (10")
No Load Speed (RPM) Kelajuan Tanpa Beban 回转数	3,500 - 6,000
Spindle Size Saiz Spinde 主轴尺寸	M10 x 1.25LH
Dimensions (L x W x H) Dimensi 体积	1,836x348x236mm (72-1/4"x13-3/4"x9-1/4")
Net Weight Berat Bersih 淨重	2.9 - 3.2kg (6.4 - 7.1lbs.)
Continuous Usage Time (approx.) Masa Penggunaan Berterusan 连续使用时间	Low: 74 min with BL1860B Plastic blade with load *Depends on the density of weeds

DUR189Z
RM 1,127

Cordless Grass Trimmer
Pemotong Rumput Tanpa Kord
充电式割草机



- Comfortable short telescopic pipe provides easy handling in tight spaces

Standard Equipment: Band Assembly, Accessory Bag, Nylon Cutting Head (198972-2), Hex Wrench

- Z: Without Charger & Battery

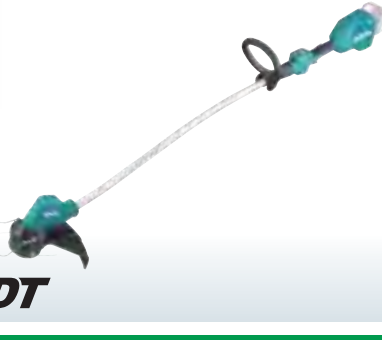

Cutting Width Lebar Keratan 切割宽度	Trimmer Head: 300mm (11-3/4") Plastic Blade: 255mm (10")
No Load Speed (RPM) Kelajuan Tanpa Beban 回转数	High: 6,000 Med: 5,000 Low: 4,000 ADT: 4,000 - 6,000
Spindle Size Saiz Spinde 主轴尺寸	M8 x 1.25RH
Dimensions (L x W x H) Dimensi 体积	1,518-1,618x258x369mm (59-3/4" - 63-3/4"x10-1/8"x14-1/2")
Net Weight Berat Bersih 淨重	3.1 - 3.4kg (6.8 - 7.5lbs.)
Continuous Usage Time (approx.) Masa Penggunaan Berterusan 连续使用时间	Low: 124 min Med: 54 min High: 46 min with BL1860B Nylon cutting head with load *Depends on the density of weeds

DUR188LRF | DUR188LZ
RM 2,282 | RM 1,305

Cordless Grass Trimmer
Pemotong Rumput Tanpa Kord
充电式割草机



- Plastic triple blade for heavy duty operation

Standard Equipment: Band Assembly, Nylon Cutting Head, Accessory Bag, Hex Wrench

- LRF: 1x Rapid Charger, 2x 3.0Ah Battery
- LZ: Without Charger & Battery



Split shaft
for easily carried & store in car boot
Batang berasingan mudah dimasukkan dalam kereta
可拆分的把手 方便放入车箱

Cutting Width Lebar Keratan 切割宽度	Nylon Cutting Head: 300mm (11-3/4") Plastic Blade: 255mm (10")
No Load Speed (RPM) Kelajuan Tanpa Beban 回转数	High: 6,000 Med: 5,000 Low: 4,000 ADT: 4,000 - 6,000
Spindle Size Saiz Spindel 主轴尺寸	M8 x 1.25 LH
Dimensions (L x W x H) Dimensi 体积	1,791x258x232mm (70-1/2"x10-1/8"x9-1/8")
Net Weight Berat Bersih 淨重	3.7 - 4.0kg (8.1 - 8.8lbs)
Continuous Usage Time (approx.) Masa Penggunaan Berterusan 连续使用时间	Low: 124 min Med: 54 min High: 46 min with BL1860B Nylon cutting head with load



DUR187/188 Models and specs may vary by country

* All list price shown are for reference only (exclude SST).

* Semua harga yang ditunjukkan adalah untuk rujukan sahaja (tidak termasuk SST). 所有显示的建议零售价仅供参考 (不包括SST)。



Li-ion Ah 6.0 5.0 4.0 3.0 2.0 1.5

DUR188URFE

RM 2,275

Cordless Grass Trimmer

Pemotong Rumput Tanpa Kord
充电式割草机

- Plastic triple blade for heavy duty operation

Standard Equipment: Band Assembly, Nylon Cutting Head, Accessory Bag, Hex Wrench

- URFE : 1 x Rapid Charger, 2 x 3.0Ah Battery



Split shaft
for easily carried & store in car boot
Batang berasingan mudah dimasukkan dalam kereta
可拆分的把手 方便放入车箱

Cutting Width Lebar Keratan 切割宽度	Nylon Cutting Head: 300mm (11-3/4") Plastic Blade: 255mm (10")
No Load Speed (RPM) Kelajuan Tanpa Beban 回转数	High: 6,000 Med: 5,000 Low: 4,000 ADT: 4,000 - 6,000
Spindle Size Saiz Spinde 主轴尺寸	M8 x 1.25LH
Dimensions (L x W x H) Dimensi 体积	1,791x600x472mm (70-1/2"x23-5/8"x18-5/8")
Net Weight Berat Bersih 淨重	3.5 - 3.8kg (7.7 - 8.3lbs)
Continuous Usage Time (approx.) Masa Penggunaan Berterusan 连续使用时间	Low: 124 min Med: 54 min High: 46 min with BL1860B Nylon cutting head with load

DUR187LRFE | DUR187LZ

RM 2,052

RM 1,075

Cordless Grass Trimmer

Pemotong Rumput Tanpa Kord
充电式割草机

- 4 Mode rotation selection: 3 stages + ADT mode

Standard Equipment: Band Assembly, Nylon Cutting Head, Accessory Bag, Hex Wrench

- LRFE: 1x Rapid Charger, 2x 3.0Ah Battery
- LZ: Without Charger & Battery

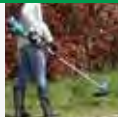

DUR187/188 VIDEO CLIP Models and specs may vary by country

Cutting Width Lebar Keratan 切割宽度	Nylon Cutting Head: 300mm (11-3/4") Plastic Blade: 255mm (10")
No Load Speed (RPM) Kelajuan Tanpa Beban 回转数	High: 6,000 Med: 5,000 Low: 4,000 ADT: 4,000 - 6,000
Spindle Size Saiz Spinde 主轴尺寸	M8 x 1.25LH
Dimensions (L x W x H) Dimensi 体积	1,791x258x232mm (70-1/2"x10-1/8"x9-1/8")
Net Weight Berat Bersih 淨重	3.4 - 3.7kg (7.5 - 8.2lbs)
Continuous Usage Time (approx.) Masa Penggunaan Berterusan 连续使用时间	Low: 124 min Med: 54 min High: 46 min with BL1860B Nylon cutting head with load

DUR184LZ

RM 1,400

Cordless Grass Trimmer

Pemotong Rumput Tanpa Kord
充电式割草机

- Low noise level for improved user comfort

Standard Equipment: Safety Goggles, Band Assembly, Nylon Cutting Head, Accessory Bag, Hex Wrench

- LZ : Without Charger & Battery



Cutting Width Lebar Keratan 切割宽度	Trimmer Head: 300mm (11-3/4")
Spindle Size Saiz Spinde 主轴尺寸	M8 x 1.25RH
Max Output Keluasan Maksima 最大输出	250W
No Load Speed (RPM) Kelajuan Tanpa Beban 回转数	High: 6,000 Low: 5,000
Dimensions (L x W x H) Dimensi 体积	1,534-1,634x258x417mm (60-1/2" - 64-1/2"x10-1/8"x16-3/8")
Net Weight Berat Bersih 淨重	3.1 - 3.4kg (6.8 - 7.5lbs)
Continuous Usage Time (approx.) Masa Penggunaan Berterusan 连续使用时间	80 min with BL1850B

DUR182LRF | DUR182LZ

RM 2,203

RM 1,548

Cordless Grass Trimmer

Pemotong Rumput Tanpa Kord
充电式割草机

- BL motor for faster cutting

Standard Equipment: Safety Goggles, Band Assembly, Nylon Cutting Head, Accessory Bag, Hex Wrench

- LRF : 1x Rapid Charger, 1x 3.0Ah Battery
- LZ : Without Charger & Battery



Cutting Width Lebar Keratan 切割宽度	Trimmer Head: 300mm (11-3/4") Metal Blade: 230mm (9")
No Load Speed (RPM) Kelajuan Tanpa Beban 回转数	3,500 - 6,000
Spindle Size Saiz Spinde 主轴尺寸	M8 x 1.25 LH
Dimensions (L x W x H) Dimensi 体积	1,843x287x253mm (72-1/2"x11-1/4"x10")
Net Weight Berat Bersih 淨重	3.6kg (8.0lbs)
Continuous Usage Time (approx.) Masa Penggunaan Berterusan 连续使用时间	61 min with BL1830B Nylon cutting head with load

DUR181Z

RM 632

Cordless String Trimmer

Pemotong Rumput Tanpa Kord
充电式割草机

- Lightweight for reduced operator fatigue

Standard Equipment: Safety Goggles, Band Assembly, Nylon Cutting Head, Nylon Cord

- Z : Without Charger & Battery



Cutting Width Lebar Keratan 切割宽度	Trimmer Head: 260mm (10-1/4")
No Load Speed (RPM) Kelajuan Tanpa Beban 回转数	7,800
Dimensions (L x W x H) Dimensi 体积	1,229 - 1,433x267x186 - 257mm (48-1/2" - 56-1/2"x10-1/2"x7-3/8" - 10-1/8")
Net Weight Berat Bersih 淨重	2.8 - 3.1kg (6.2 - 6.9lbs.)
Continuous Usage Time (approx.) Masa Penggunaan Berterusan 连续使用时间	45 min with BL1830B Nylon cutting head with load

* All list price shown are for reference only (exclude SST).

* Semua harga yang ditunjukkan adalah untuk rujukan sahaja (tidak termasuk SST). 所有显示的建议零售价仅供参考 (不包括SST)。





Li-ion Ah 6.0 5.0 4.0 3.0 2.0 1.5

DLM160Z

RM 1,057

Cordless Hand Push Lawn Trimmer

Mesin Pemotong Rumput Tanpa Kord
充电式手推草坪修剪机

- World's First Cordless Hand Push Lawn Trimmer

Standard Equipment: Rotary Blade, Fixed Blade, Lock Nut Wrench

- Z: Without Charger & Battery



Cutting Width Lebar Keratan 切割宽度	160mm (6-5/16")
Cutting Height Ketinggian Pemotongan 切割高度	10 / 15 / 20 / 25 / 30 / 35 / 40mm
Grass box capacity Kapasiti Kotak Rumput 草箱容量	8.4L
No Load Speed (RPM) Kelajuan Tanpa Beban 回转数	1,600
Wheel Size Saiz Roda 轮片尺寸	Front / Rear: 230mm (9")
Dimensions (L x W x H) Dimensi 体积	346x178x751-1,046mm
Net Weight Berat Bersih 净重	5.8kg
Continuous Usage Time (approx.) Masa Penggunaan Berterusan 连续使用时间	Mowing Area 190m ² or 39 min with BL1860B

DUX18RGX4 DUX18Z

RM 2,460

RM 1,040

Cordless Multi Function Power Head

Powerhead Pelbagai Fungsi Tanpa Kord
充电式多功能动力机



*Not compatible with 2.0Ah, 1.5Ah batteries

- Split system of Power head and Attachment provides easier portability

Standard Equipment: Shoulder Harness, Hex Wrench, Safety Goggles (195246-2), Accessory Bag

- RGX4: 1x Rapid Charger, 1x 6.0Ah Battery, 1x Tool Bag
1x Brushcutter Attachment EM408MP, 1x Nylon Cutting Head
- Z: Without Charger & Battery



Max Output Keluaran Maksima 最大输出	0.47kw
No Load Speed (RPM) Kelajuan Tanpa Beban 回转数	High: 0 - 9,700 Low: 0 - 6,800
Dimensions (L x W x H) Dimensi 体积	983x318x175mm (38-3/4x12-1/2x6-7/8")
Net Weight Berat Bersih 净重	2.8 - 3.1kg (6.2 - 6.8lbs.)

DUH754SRT DUH754SZ 750mm (29-1/2")

RM 4,275

RM 3,463

Cordless Hedge Trimmer

Pemangkas Tanaman Pagar Tanpa Kord
充电式篱笆树剪



- Excellent balance of high power and lightweight

Standard Equipment: Blade Cover, Chip Receiver, Safety Goggles

- SRT: 1x Rapid Charger, 1x 5.0Ah Battery
- SZ: Without Charger & Battery



Blade Length Panjang bilah 刀片长度	750mm (29-1/2")
Strokes Per Minute (SPM) Kelajuan Strok 冲程速度	High: 4,400 Med: 3,600 Low: 2,000
Tooth Spacing Selang Gigi 牙齿间隔	35mm (1-3/8")
Max Cutting Capacity Kapasiti Pemotongan Maksimum 最大切割能力	23.5mm (15/16")
Dimensions (L x W x H) Dimensi 体积	1,200x282x143mm (47-1/4"x11-1/8"x5-5/8")
Net Weight Berat Bersih 净重	3.4 - 3.9kg (7.5 - 8.6lbs.)
Continuous Usage Time (approx.) Masa Penggunaan Berterusan 连续使用时间	Low: 190 min Med: 80 min High: 65 min with BL1860B

DUH601Z 600mm (23-5/8")

RM 1,905

Cordless Hedge Trimmer

Pemangkas Tanaman Pagar Tanpa Kord
充电式篱笆树剪



- 5-Position rotating rear handle for increased comfort during vertical and angle trimming

Standard Equipment: Blade Cover, Safety Goggles

- Z: Without Charger & Battery



DUH601 VIDEO CLIP Models and specs may vary by country

Blade Length Panjang bilah 刀片长度	600mm (23-5/8")
Strokes Per Minute (SPM) Kelajuan Strok 冲程速度	High: 0 - 4,400 Med: 0 - 3,600 Low: 0 - 2,000
Max Cutting Capacity Kapasiti Pemotongan Maksimum 最大切割能力	23.5mm (15/16")
Tooth Spacing Selang Gigi 牙齿间隔	35mm (1 - 3/8")
Dimensions (L x W x H) Dimensi 体积	1,121x192x225mm (44-1/8"x7-1/2"x8-7/8")
Net Weight Berat Bersih 净重	3.8 - 4.5kg (8.4 - 9.8lbs.)
Continuous Usage Time (approx.) Masa Penggunaan Berterusan 连续使用时间	Low: 200 min High: 55 min with BL1860B

DUH523RME DUH523RFE DUH523Z 520mm (20-1/2")

RM 1,868

RM 1,705

RM 730

Cordless Hedge Trimmer

Pemangkas Tanaman Pagar Tanpa Kord
充电式篱笆树剪



- Delivers 2,700 SPM for increased cutting speed

Standard Equipment: Blade Cover (452685-2)

- RME: 1x Rapid Charger, 2x 4.0Ah Battery
- RFE: 1x Rapid Charger, 2x 3.0Ah Battery
- Z: Without Charger & Battery



Blade Length Panjang bilah 刀片长度	520mm (20-1/2")
Strokes Per Minute (SPM) Kelajuan Strok 冲程速度	2,700
Tooth Spacing Selang Gigi 牙齿间隔	15mm (9/16")
Dimensions (L x W x H) Dimensi 体积	938x195x193mm (37"x7-5/8"x7-5/8")
Max Output Keluaran Maksima 最大输出	210W
Net Weight Berat Bersih 净重	3.0 - 3.4kg (6.7 - 7.5lbs)
Continuous Usage Time (approx.) Masa Penggunaan Berterusan 连续使用时间	130 min with BL1850B

* All list price shown are for reference only (exclude SST).

* Semua harga yang ditunjukkan adalah untuk rujukan sahaja (tidak termasuk SST). 所有显示的建议零售价仅供参考 (不包括SST)。

Cordless Target Kordless
LED Flashlight Lampu Cahaya LED
Vacuum Cleaner Penyedut Vakuum
Drilling / Fastening
Impact Drilling / Demolition
Cutting
Grinding / Sanding
Sawing
Planing / Routing
Drivers



18V

LXT

Li-ion Ah 6.0 5.0 4.0 3.0 2.0 1.5

Cordless Hedge Trimmer

Pemangkas Tanaman Pagar Tanpa Kord 充电式篱笆树剪

Adjustable Angle

Sudut bilah boleh laras
可调角度

DUN500W

Blade Length: 500mm (19-3/4")

Light weight
Ringan 轻量
3.9kg
with BL1815N
1.5Ah Battery
DUN500W

Band assembly can be attached

Cangkuk untuk tali bahu
肩带吊扣

2 grips

Pemegang 前把手

The angle of hedge trimmer head can be changed simply by operating a lever

Pelaras sudut 滑动调节套筒

Loop handle

Pemegang gelung
环形手柄

Maximum branch diameter

diameter maksimum 最大分支直径

23.5mm

Non-angle adjustable hedge trimmer head

Tidak boleh laras
不可调节

DUN600L

Blade Length: 600mm (23-5/8")

Light weight
Ringan 轻量
3.7 kg
with BL1815N
1.5Ah Battery
DUN600L

DUN500WZ 500mm (19-3/4")

RM 2,735

Cordless Hedge Trimmer
Pemangkas Tanaman Pagar
Tanpa Kord
充电式篱笆树剪



• Lightweight for reduced operator fatigue

Standard Equipment: Blade Cover, Band Assembly

• WZ: Without Charger & Battery



Blade Length Panjang Bilah 刀片长度	500mm (19-3/4")
Strokes Per Minute (SPM) Kelajuan Strok 冲程速度	High: 4,400 Med: 3,600 Low: 2,000
Tooth Spacing Selang Gigi 牙齿间隔	35mm (1-3/8")
Max Cutting Capacity Kapasiti Pemotongan Maksimum 最大切割能力	23.5mm (15/16")
Dimensions (L x W x H) Dimensi 体积	2,115x97x137mm (83-1/4"x3-13/16"x5-3/8")
Net Weight Berat Bersih 净重	3.9 - 4.3kg (8.6 - 9.5lbs.)
Continuous Usage Time (approx.) Masa Penggunaan Berterusan 连续使用时间	Low: 190 min Med: 90 min High: 60 min with BL1860B

DUN600LZ 600mm (23-5/8")

RM 2,553

Cordless Hedge Trimmer
Pemangkas Tanaman Pagar
Tanpa Kord
充电式篱笆树剪



• Lightweight for reduced operator fatigue

Standard Equipment: Blade Cover, Hex Wrench

• LZ: Without Charger & Battery



Blade Length Panjang Bilah 刀片长度	600mm (23-5/8")
Strokes Per Minute (SPM) Kelajuan Strok 冲程速度	High: 4,400 Med: 3,600 Low: 2,000
Tooth Spacing Selang Gigi 牙齿间隔	35mm (1-3/8")
Max Cutting Capacity Kapasiti Pemotongan Maksimum 最大切割能力	23.5mm (15/16")
Dimensions (L x W x H) Dimensi 体积	2,050x230x178mm (80-1/2"x9"x7")
Net Weight Berat Bersih 净重	3.7 - 4.1kg (8.2 - 9.0lbs.)
Continuous Usage Time (approx.) Masa Penggunaan Berterusan 连续使用时间	Low: 180 min Med: 80 min High: 55 min with BL1860B

* All list price shown are for reference only (exclude SST).

* Semua harga yang ditunjukkan adalah untuk rujukan sahaja (tidak termasuk SST). 所有显示的建议零售价仅供参考 (不包括SST)。

Cordless
Tempat
LED Flashlight
Vacuum Cleaner
Drilling / Fastening
Impact Drilling / Demolition
Cutting
Grinding / Smoothing
Others
Outdoor Power Equipment





Li-ion Ah 6.0 | 5.0 | 4.0 | 3.0 | 2.0 | 1.5

DUM604Z 160mm (6-5/16")

RM 632

Cordless Grass Shear
Pemotong Rumput Tanpa Kord
充电式割草机



- 2 in 1: trimmer and shear blade can be attached

Standard Equipment: Grass Receiver, Blade Cover

- Z: Without Charger & Battery

Cutting Width Lebar Keratan 切割宽度	160mm (6-5/16")
Depth Adjustment Pelarasan Kedalaman 深度调整	15mm (9/16") 20mm (13/16") 25mm (1")
Strokes Per Minute (SPM) Kelajuan Strok 冲程速度	2,500
Dimensions (L x W x H) Dimensi 体积	337x177x131mm (13-1/4"x7"x5-1/8")
Net Weight Berat Bersih 净重	1.4 - 1.8kg (3.2 - 4.0 lbs)
Continuous Usage Time (approx.) Masa Penggunaan Berterusan 连续使用时间	200 min with BL1850B 250 min with BL1860B

DUM168Z 160mm (6-5/16")

RM 638

Cordless Grass Shear
Pemotong Rumput Tanpa Kord
充电式割草机



- 2 in 1: trimmer and shear blade can be attached

Standard Equipment: Base Frame, Blade Cover

- Z: Without Charger & Battery

Cutting Width Lebar Keratan 切割宽度	160mm (6-5/16")
Depth Adjustment Pelarasan Kedalaman 深度调整	10mm (3/8") 20mm (13/16") 30mm (1 - 3/16")
Strokes Per Minute (SPM) Kelajuan Strok 冲程速度	2,500
Dimensions (L x W x H) Dimensi 体积	353x176x130mm (13-7/8"x6-15/16"x5-1/8")
Net Weight Berat Bersih 净重	1.4kg (3.0lbs.)
Continuous Usage Time (approx.) Masa Penggunaan Berterusan 连续使用时间	220 min with BL1850B

DUM111SYX 110mm (4-5/16")

RM 870

Cordless Grass Shear
Pemotong Rumput Tanpa Kord
充电式割草机



- 2 in 1: Both trimmer blade and shear blade can be attached

Standard Equipment:

Grass Shear Blade 110mm (191N23-4),
Grass Shear Blade 110mm Cover (413885-9),
Hedge Trimmer Blade 200mm (198408-1),
Blade Cover Set (195274-7), Oil Vessel
(to include hedge trimmer part)



Come with

Hedge Trimmer Blade (198408-1)



- SYX: 1x Standard Charger, 1x 1.5Ah Battery

Cutting Width Lebar Keratan 切割宽度	Grass Shear Blade: 110mm (4-5/16") Hedge Trimmer Blade: 200mm (7-7/8")
Depth Adjustment Pelarasan Kedalaman 深度调整	15mm (9/16") 20mm (13/16") 25mm (1")
Strokes Per Minute (SPM) Kelajuan Strok 冲程速度	2,500
Dimensions (L x W x H) Dimensi 体积	330x120x130mm (13x4-3/4x5-1/8")
Net Weight Berat Bersih 净重	1.4 - 1.8kg (3.1 - 4.0lbs.)
Continuous Usage Time (approx.) Masa Penggunaan Berterusan 连续使用时间	220 min with BL1850B

DUC254Z 250mm (10")

RM 1,698

Cordless Chain Saw
Gergaji Rantai Tanpa Kord
充电式链锯



- High Cutting Performance, Ultra Lightweight Top Handle Chain Saw

Standard Equipment: Saw Chain (199075-5),
Guide Bar (161846-0), Guide Bar Cover (458501-6/ 452093-7)

- Z: Without Charger & Battery



Guide Bar Length Panjang Bar Panduan 导板长度	250mm (10")
Chain Pitch Kerapatan Rantai 链条齿距	9.5mm (3/8")
Chain Gauge Ketebalan Rantai 链条厚度	1.1 (0.043") or 1.3mm (0.050")
Chain Speed Kelajuan Rantai 链条速度	0 - 24m/s (0 - 1,440m/min) (0 - 4,720FPM)
Chain Oil Tank Volume Tangki Minyak Pelincir 链油箱	140mL (4.8US oz)
Dimensions (L x W x H) Dimensi 体积	256x185x190mm (10-1/8"x7-1/2"x7-1/4")
Net Weight Keberatan 净重	2.8 - 3.3kg (6.3 - 7.3lbs)
Work Amount (approx.) Jumlah Kerja 工作量	160 cuts with BL1850B 50 mm Cedar timber

DUC122Z 115mm (4-1/2")

RM 1,532

Cordless Chain Saw
Gergaji Rantai Tanpa Kord
充电式链锯

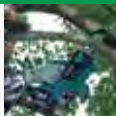

- Low noise & zero emissions for operator comfort

Standard Equipment: Saw Chain (791284-8),
Guide Bar (158476-6), Guide Bar Cover (416311-7), Chain Oil, File

- Z: Without Charger & Battery



Guide Bar Length Panjang Bar Panduan 导板长度	115mm (4-1/2")
Chain Pitch Kerapatan Rantai 链条齿距	6.35mm (1/4")
Chain Gauge Ketebalan Rantai 链条厚度	1.3mm (0.05")
Chain Speed Kelajuan Rantai 链条速度	5.0m/s (300m/min) (980FPM)
Chain Oil Tank Volume Tangki Minyak Pelincir 链油箱	80mL (2.7US oz)
Dimensions (L x W x H) Dimensi 体积	422x195x215mm (16-5/8"x7-5/8"x8-1/2")
Net Weight Keberatan 净重	2.6kg (5.7lbs)
Work Amount (approx.) Jumlah Kerja 工作量	320 cuts BL1850B 50 mm Timber

* All list price shown are for reference only (exclude SST).

* Semua harga yang ditunjukkan adalah untuk rujukan sahaja (tidak termasuk SST). 所有显示的建议零售价仅供参考 (不包括SST)。

Cordless
Terdapat Tanpa Kord

LED Flashlight
Lampu Cahaya LED
LED BERMILAH

Vacuum Cleaner
Penyedut Vakuum
BUKUK

Drilling / Fastening
Druai / Pasang
MIL / 釘

Impact Drilling / Demolition
Druai / Demolisi
MIL / 釘

Cutting / Pruning
Potong / Pemangkai
MIL / 釘

Grinding / Sanding
Tungku / Pasang
MIL / 釘

Sawing
Druai
MIL / 釘

Planing / Routing
Tungku / Pasang
MIL / 釘

Others
Lain-lain
MIL / 釘

Outdoor Power Equipment
Alat Kuasa Luar
MIL / 釘

Makita
MIL / 釘

18V

LXT

Li-ion Ah 6.0 5.0 4.0 3.0 2.0 1.5

DUB184RT DUB184Z

RM 2,005

RM 1,193

Cordless Blower

Mesin Penghembus Angin
Tanpa Kord
充电式吹风机



- Compact and lightweight for single handed operation

Standard Equipment: Nozzle, Hex Wrench

- RT: 1x Rapid Charger, 1x 5.0Ah Battery
- Z: Without Charger & Battery



Max Air Volume Isipadu Angin Maksimum 最大风量	13.0m ³ /min (459CFM)
Max Air Velocity Velositi Angin Maksimum 最大风速	52.1m/s (116MPH)
No Load Speed (RPM) Kelajuan Tanpa Beban 回转数	0 - 18,000
Dimensions (L x W x H) Dimensi 体积	825x160x285mm (32-1/2"x6-5/16"x11-1/4")
Net Weight Berat Bersih 净重	2.5 - 3.0kg (5.4 - 6.7lbs.)
Continuous Usage Time (approx.) Masa Penggunaan Berterusan 连续使用时间	12 min with BL1860B



VIDEO CLIP
Models and specs
may vary by country

DUB183Z

RM 500

Cordless Blower

Mesin Penghembus Angin
Tanpa Kord
充电式吹风机



- Long blowing nozzle with curved tip for optimal blowing performance

Standard Equipment: Garden Nozzle

- Z: Without Charger & Battery



Air Volume Isipadu Angin 风量	2.6m ³ /min
Air Speed Kelajuan Angin 风速	52m/s
No Load Speed (RPM) Kelajuan Tanpa Beban 回转数	0-18,000
Dimensions (L x W x H) Dimensi 体积	845x155x212mm (33-1/4"x6-1/8"x8-3/8")
Net Weight Berat Bersih 净重	1.7kg (3.8lbs)
Continuous Usage Time (approx.) Masa Penggunaan Berterusan 连续使用时间	Low: 129 min Med: 43 min High: 18 min with BL1850B

DUB186Z

RM 500

Cordless Blower

Mesin Penghembus Angin
Tanpa Kord
充电式吹风机

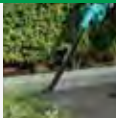

- Compact and lightweight for single handed operation

Standard Equipment: Garden Nozzle (191G09-6)

- Z: Without Charger & Battery



Max Air Volume Isipadu Angin Maksimum 最大风量	3.2m ³ /min
Max Air Velocity Velositi Angin Maksimum 最大风速	68m/s
Avg. Air Velocity Kelajuan Angin Purata 平均风速	56m/s
No Load Speed (RPM) Kelajuan Tanpa Beban 回转数	0 - 18,000
Dimensions (L x W x H) Dimensi 体积	861x156x210mm (34x6-1/8x8-1/4")
Net Weight Berat Bersih 净重	1.6 - 2.1kg (3.5 - 4.6lbs.)
Continuous Usage Time (approx.) Masa Penggunaan Berterusan 连续使用时间	Low: 130 min Med: 45 min High: 16 min with BL1850B

DUB185Z

RM 382

Cordless Blower

Mesin Penghembus Angin
Tanpa Kord
充电式吹风机



- Larger air volume has been obtained by increasing the air outlet diameter

Standard Equipment: Nozzle

- Z: Without Charger & Battery



Max Air Volume Isipadu Angin Maksimum 最大风量	3.2m ³ /min
Max Air Velocity Velositi Angin Maksimum 最大风速	98m/s
Avg. Air Velocity Kelajuan Angin Purata 平均风速	81m/s
Max Sealed Suction Sedutan Terkedap 最大密封吸力	5.8kPa
No Load Speed (RPM) Kelajuan Tanpa Beban 回转数	0 - 18,000
Dimensions (L x W x H) Dimensi 体积	517x156x210mm (20-3/8x6-1/8x8-1/4")
Net Weight Berat Bersih 净重	1.6 - 2.1kg (3.5 - 4.6lbs.)
Continuous Usage Time (approx.) Masa Penggunaan Berterusan 连续使用时间	Low: 130 min Med: 50 min High: 21 min with BL1850B

DUB182Z

RM 382

Cordless Blower

Mesin Peniup Tanpa Kord
充电式吹风机



- Compact and ergonomic design at only 525mm (20-3/4") long

Standard Equipment: Nozzle assembly

- Z: Without Charger & Battery



Air Volume Isipadu Angin 风量	2.6m ³ /min
Air Speed Kelajuan Angin 风速	80m/s
Air Pressure Udara Tekanan 气压	5.4kPa (550mmH ₂ O)
No Load Speed (RPM) Kelajuan Tanpa Beban 回转数	0-18,000
Dimensions (L x W x H) Dimensi 体积	525x155x212mm (20-3/4"x6-1/8"x8-3/8")
Net Weight Berat Bersih 净重	1.7kg (3.7lbs)
Continuous Usage Time (approx.) Masa Penggunaan Berterusan 连续使用时间	20 min with BL1850B

* All list price shown are for reference only (exclude SST).

* Semua harga yang ditunjukkan adalah untuk rujukan sahaja (tidak termasuk SST). 所有显示的建议零售价仅供参考 (不包括SST)。

Cordless
Temperature MeterLED Flashlight
Lampu Senter LED
- LED LIGHTVacuum Cleaner
Penyedut Debu
- VACUUMDrilling / Fastening
Gergaji / Penggulung
- DRILL / NAILImpact Drilling / Demolition
Gergaji / Pecah
- IMPACT DRILLCutting
Pengiris
- CUTGrinding / Sanding
Gergaji / Hiris
- GRIND / SANDSawing
Gergaji
- SAWPlaning / Routing
Pajangan / Tugasan
- PLANER / ROUTEROthers
Lain-lain
- OTHERSOutdoor Power Equipment
Alatan Kuasa Luar
- OPEMakita
- MAKITA

18V

LXT

Li-ion Ah 6.0 | 5.0 | 4.0 | 3.0 | 2.0 | 1.5

BL MOTOR
Motor tanpa berus
无碳刷马达

XPT
EXTREME PROTECTION TECHNOLOGY
Teknologi Perlindungan Ekstrim
防尘防水滴技术

Battery Powered Wheelbarrow

Kereta Sorong Berkuasa Bateri 充电式搬运车

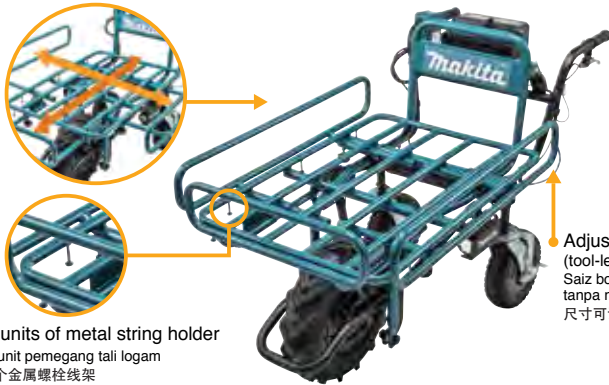

Longest running distance
Jarak perjalanan terpanjang
最长行走距离
6km
*When using BL1850B x2
*Semasa menggunakan BL1850B x2
*当使用 BL1850B x2

Maximum weight capacity
Kapasiti berat maksimum
最重载量
130kg



8 units of metal string holder
8 unit pemegang tali logam
8个金属螺栓线架

Adjustable size (tool-less)
Saiz boleh dilaras tanpa menggunakan alat
尺寸可调整 (免使用工具)

Flatbed Pipe Frame type
Jenis rak 货架型

Perfect for moving heavy loads in carton, basket and sack.
Sempurna untuk menggerakkan barang dalam kotak, bakul dan guni. 适用于装载纸箱, 篮子 and 袋装物。

Bucket type
Jenis baldi 货斗型

Ideal for carrying loose material, such as sand, soil, gravel and more.
Sesuai untuk membawa bahan seperti pasir, tanah, batu kerikil dan banyak lagi. 适用于装载松散物料, 如沙土和碎石等。



2-speed control
Kawalan 2 kelajuan
2 速度控制



Brake level with locking mechanism
Tuas brek dengan sistem berkunci
煞车锁定系统



Pedal rear wheel braking system
Pedal brek roda belakang
后轮煞车踏板



Dual LED job lights
Dua Lampu LED
两颗 LED 灯



Detachable rear wheel
Roda belakang boleh ditanggalkan
可拆卸泥地行走一轮脚架



Washable with tap water
Boleh dibasuh dengan air paip
自来水清洗



able to climb a slope gradient of
Pergerakan atas kecerunan Maksimum
最大爬坡能力
12°

* Performance may vary depending on weight of load and slope of terrain
Prestasi mungkin berbeza bergantung kepada berat barang dan kecerunan tanah 搬运车性能可能因载重和地形坡度而异

DCU180Z Bucket Set / Carrier Set

RM 5,740

Battery Powered Wheelbarrow
Kereta Sorong Berkuasa Bateri
充电式搬运车



Ideal for use at urban construction sites and on farms



VIDEO CLIP
Models and specs may vary by country

Standard Equipment:
Lock Key, Support Legs, Wrenches

*Z: Without Charger & Battery



DVF154Z 15L

RM 3,008

Cordless Garden Sprayer
Penyembur Tanaman Tanpa Kord
充电式花园喷雾器

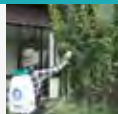

Reduced running cost with Li-ion battery



Standard Equipment: Upright Double-Headed Nozzle, Wide-Angle Herbicide Nozzle, Spray Pipe Holder, Shoulder Harness

*Z: Without Charger & Battery

Max Load Capacity Kapasiti Berat Maksimum 最重载量	130kg (290lbs.)
Traveling Speed Kelajuan Perjalanan 行驶速度	Forward High: 0 - 3.5km/h Forward Low: 0 - 1.5km/h Reverse: 0 - 1 km/h
Max Climbing Capacity Pergerakan atas Kecerunan Maksimum 最大爬坡能力	12°
Dimensions (L x W x H) Dimensi 体积	When carrier is installed/ During operation: 1,315x1,060x900mm (51-3/4"x41-3/4"x35-1/2") When carrier is installed/ When stored: 1,110x820x820mm (43-3/4"x32-1/4"x32-1/4") When bucket is installed/ During operation: 1,310x820x900 mm (51-1/2"x32-1/4"x35-1/2") When bucket is installed/ When stored: 1,110x820x820mm (43-3/4"x32-1/4"x32-1/4")
Net Weight Keberatan 净重	39.3 - 44.8kg (86.5 - 98.7lbs)
Continuous Usage Time (approx.) Masa Penggunaan Berterusan 连续使用时间	120 min with BL1860B x2

Max Pressure Tekanan Maksimum 最大水压	0.3MPa (3 kgf/cm ²)
Chemical Tank Tangki Kimia 化学箱容量	15L
Dimensions (L x W x H) Dimensi 体积	345x235x525mm (13-5/8"x9-1/4"x20-3/4")
Net Weight Berat Bersih 净重	4.1 - 4.4kg (9.1 - 9.7lbs)
Continuous Usage Time (approx.) Masa Penggunaan Berterusan 连续使用时间	Wide Angle Nozzle 344 min Double Nozzle 215 min with BL1850B

* All list price shown are for reference only (exclude SST).

* Semua harga yang ditunjukkan adalah untuk rujukan sahaja (tidak termasuk SST). 所有显示的建议零售价仅供参考 (不包括SST)。

Cordless
LED Flashlight
Vacuum Cleaner
Drilling / Fastening
Impact Drilling / Demolition
Cutting
Grinding / Sanding
Sawing
Planing / Routing
Oilers





DF332DSME RM 1,510	DF332DSAE RM 1,328	DF332DZ 10mm (3/8") RM 680
------------------------------	------------------------------	--------------------------------------

Cordless Driver Drill
Gerudi Pemutar Skru Tanpa Kord
充电式螺丝起子电钻



- BL motor with high power

Standard Equipment: Phillips Bit, Belt Clip

- DSME: 1x Speed Charger, 2x 4.0Ah Battery
- DSAE: 1x Speed Charger, 2x 2.0Ah Battery
- DZ: Without Charger, Battery & Carrying Case

Capacity
Kapasiti 能力
Steel: 10 (3/8")
Wood: 28mm (1-1/8")

Chuck Capacity
Kapasiti Chuck 夹头能力
0.8 - 10mm (1/32 - 3/8")

No Load Speed (RPM)
Kelajuan Tanpa Beban 回转数
High: 0 - 1,500 | Low: 0 - 450

Max Fastening Torque
Maksimum Tenaga Pemutaran Pengancing 最快扭力
Hard: 35N-m (310in.lbs.)
Soft: 21N-m (190in.lbs.)

Max Lock Torque
Pemutaran Tenaga Maksimum 最大扭矩
32N-m (280in.lbs.)

Dimensions (L x W x H)
Dimensi 体积
154x66x217mm (6-1/16"x2-5/8"x8-1/2")

Net Weight
Berat Bersih 淨重
1.0 - 1.2kg (2.3 - 2.6lbs)

Work Amount (approx.)
Jumlah Kerja 工作量
460 holes with BL1021B
Drilling ø9mm Auger Bit,
Melapi 30mm Thickness

DF333DSME RM 1,160	DF333DWAE RM 895	DF333DWYE RM 840	DF333DZ 10mm (3/8") RM 330
------------------------------	----------------------------	----------------------------	--------------------------------------

Cordless Driver Drill
Gerudi Pemutar Skru Tanpa Kord
充电式螺丝起子电钻



- Increased motor power for higher speed and max tightening torque

Standard Equipment: Phillips Bit, Belt Clip

- DSME: 1x Speed Charger, 2x 4.0Ah Battery
- DWAE: 1x Standard Charger, 2x 2.0Ah Battery
- DWYE: 1x Standard Charger, 2x 1.5Ah Battery
- DZ: Without Charger, Battery & Carrying Case

Capacity
Kapasiti 能力
Steel: 10mm (3/8")
Wood: 21mm (13/16")

Chuck Capacity
Kapasiti Chuck 夹头能力
0.8 - 10mm (1/32 - 3/8")

No Load Speed (RPM)
Kelajuan Tanpa Beban 回转数
High: 0 - 1,700 | Low: 0 - 450

Max Fastening Torque
Maksimum Tenaga Pemutaran Pengancing 最快扭力
Hard: 30N-m (270in.lbs.)
Soft: 14N-m (130in.lbs.)

Max Lock Torque
Pemutaran Tenaga Maksimum 最大扭矩
28N-m (250in.lbs.)

Dimensions (L x W x H)
Dimensi 体积
179x66x212mm (7"x2-5/8"x8-3/8")

Net Weight
Berat Bersih 淨重
1.1 - 1.2kg (2.4 - 2.7lbs.)

DF331DSME RM 1,160	DF331DZ 10mm (3/8") RM 330
------------------------------	--------------------------------------

Cordless Driver Drill
Gerudi Pemutar Skru Tanpa Kord
充电式螺丝起子电钻



- Increased motor power for higher speed

Standard Equipment: Phillips Bit, Belt Clip

- DSME: 1x Speed Charger, 2x 4.0Ah Battery
- DZ: Without Charger, Battery & Carrying Case

Capacity
Kapasiti 能力
Steel: 10mm (3/8")
Wood: 21mm (13/16")

Chuck Capacity
Kapasiti Chuck 夹头能力
0.8 - 10mm (1/32 - 3/8")

No Load Speed (RPM)
Kelajuan Tanpa Beban 回转数
High: 0 - 1,700 | Low: 0 - 450

Max Fastening Torque
Maksimum Tenaga Pemutaran Pengancing 最快扭力
Hard: 30N-m (270in.lbs.)
Soft: 14N-m (130in.lbs.)

Max Lock Torque
Pemutaran Tenaga Maksimum 最大扭矩
28N-m (250in.lbs.)

Dimensions (L x W x H)
Dimensi 体积
189x66x209mm (7-7/16"x2-5/8"x8-1/4")

Net Weight
Berat Bersih 淨重
1.1 - 1.3kg (2.4 - 2.8lbs)

Work Amount (approx.)
Jumlah Kerja 工作量
350 holes with BL1021B
Drilling ø9mm Auger Bit,
Melapi 30mm Thickness

DF032DSME RM 1,488	DF032DSAE RM 1,305	DF032DZ 10mm (3/8") RM 658
------------------------------	------------------------------	--------------------------------------

Cordless Driver Drill
Gerudi Pemutar Skru Tanpa Kord
充电式螺丝起子电钻



- BL motor with high power

Standard Equipment: Phillips Bit, Belt Clip

- DSME: 1x Speed Charger, 2x 4.0Ah Battery
- DSAE: 1x Speed Charger, 2x 2.0Ah Battery
- DZ: Without Charger, Battery & Carrying Case

Capacity
Kapasiti 能力
Steel: 10mm (3/8")
Wood: 28mm (1-1/8")

Chuck Capacity
Kapasiti Chuck 夹头能力
6.35mm (1/4")

No Load Speed (RPM)
Kelajuan Tanpa Beban 回转数
High: 0 - 1,500 | Low: 0 - 450

Max Fastening Torque
Maksimum Tenaga Pemutaran Pengancing 最快扭力
Hard: 35N-m (310in.lbs.)
Soft: 21N-m (190in.lbs.)

Max Lock Torque
Pemutaran Tenaga Maksimum 最大扭矩
32N-m (280in.lbs.)

Dimensions (L x W x H)
Dimensi 体积
124x66x217mm (4-7/8"x2-5/8"x8-1/2")

Net Weight
Berat Bersih 淨重
0.88 - 1kg (1.9 - 2.3lbs)

Work Amount (approx.)
Jumlah Kerja 工作量
200 holes with BL1021B
Wood Drilling ø3x1.6mm

DF033DSME RM 1,127	DF033DWAE RM 862	DF033DZ 10mm (3/8") RM 298
------------------------------	----------------------------	--------------------------------------

Cordless Driver Drill
Gerudi Pemutar Skru Tanpa Kord
充电式螺丝起子电钻



- Increased motor power for higher speed and max tightening torque

Standard Equipment: Phillips Bit, Belt Clip

- DSME: 1x Speed Charger, 2x 4.0Ah Battery
- DWAE: 1x Standard Charger, 2x 2.0Ah Battery
- DZ: Without Charger, Battery & Carrying Case

Capacity
Kapasiti 能力
Steel: 10mm (3/8")
Wood: 21mm (13/16")

Chuck Capacity
Kapasiti Chuck 夹头能力
6.35mm (1/4")

No Load Speed (RPM)
Kelajuan Tanpa Beban 回转数
High: 0 - 1,700 | Low: 0 - 450

Max Fastening Torque
Maksimum Tenaga Pemutaran Pengancing 最快扭力
Hard: 30N-m (270in.lbs.)
Soft: 14N-m (130in.lbs.)

Max Lock Torque
Pemutaran Tenaga Maksimum 最大扭矩
28N-m (250in.lbs.)

Dimensions (L x W x H)
Dimensi 体积
149x66x212mm (5-7/8"x2-5/8"x8-3/8")

Net Weight
Berat Bersih 淨重
0.9 - 1.1kg (2.1 - 2.4lbs.)

* All list price shown are for reference only (exclude SST).

* Semua harga yang ditunjukkan adalah untuk rujukan sahaja (tidak termasuk SST). 所有显示的建议零售价仅供参考 (不包括SST)。

Cordless
LED Flashlight
Vacuum Cleaner
Drilling / Fastening
Impact Drilling / Demolition
Cutting / Trimming
Grinding / Sanding
Sawing
Planing / Routing
Others
Outdoor Power Equipment



12V_{max}

CXT

Li-ion Ah 4.0 2.0 1.5

DF031DSME RM 1,127 | **DF031DWAE** RM 862 | **DF031DWYE** RM 807 | **DF031DZ** 10mm (3/8") RM 298

Cordless Driver Drill
Gerudi Pemutar Skru Tanpa Kord
充电式螺丝起子电钻



• Ideal for work in tight spaces

Standard Equipment: Phillips Bit, Belt Clip

- DSME: 1x Speed Charger, 2x 4.0Ah Battery
- DWAE: 1x Standard Charger, 2x 2.0Ah Battery
- DWYE: 1x Standard Charger, 2x 1.5Ah Battery
- DZ: Without Charger, Battery & Carrying Case



*Not applicable for Z model

Capacity Kapasiti 能力	Steel: 10mm (3/8") Wood: 21mm (13/16") 6.35mm (1/4")
Hex Shank Batang Heksagon 六角柄	
No Load Speed (RPM) Kelajuan Tanpa Beban 回转数	High: 0 - 1,700 Low: 0 - 450
Max Fastening Torque Maksimum Tenaga Pemutaran Pengancing 最快扭力	Hard: 30N-m (270in.lbs.) Soft: 14N-m (130in.lbs.)
Max Lock Torque Pemutaran Tenaga Maksimum 最大扭矩	28N-m (250in.lbs.)
Dimensions (L x W x H) Dimensi 体积	157x66x209mm (6-3/16"x2-5/8"x8-1/4")
Net Weight Berat Bersih 淨重	0.94 - 1.1kg (2.1 - 2.5lbs)
Work Amount (approx.) Jumlah Kerja 工作量	160 holes with BL1021B Wood Drilling ø3x1.6mm

HP332DSME RM 1,577 | **HP332DSAE** RM 1,395 | **HP332DZ** 10mm (3/8") RM 748

Cordless Hammer Driver Drill
Tukul Pemutar Skru Bergerudi Tanpa Kord
充电式冲击螺丝起子电钻



• Fast hammer drilling in masonry materials

Standard Equipment: Phillips Bit, Belt Clip

- DSME: 1x Speed Charger, 2x 4.0Ah Battery
- DSAE: 1x Speed Charger, 2x 2.0Ah Battery
- DZ: Without Charger, Battery & Carrying Case



*Not applicable for Z model



Capacity Kapasiti 能力	Steel: 10mm (3/8") Wood: 28mm (1-1/8") Masonry: 8mm (5/16")
Chuck capacity Kapasiti Chuck 夹头能力	0.8 - 10mm (1/32 - 3/8")
Impacts Per Minute (IPM) Impak Per Minit 冲击数	High: 0 - 22,500 Low: 0 - 6,750
No Load Speed (RPM) Kelajuan Tanpa Beban 回转数	High: 0 - 1,500 Low: 0 - 450
Max Fastening Torque Maksimum Tenaga Pemutaran Pengancing 最快扭力	Hard: 35N-m (310in.lbs.) Soft: 21N-m (190in.lbs.)
Max Lock Torque Pemutaran Tenaga Maksimum 最大扭矩	32N-m (280in.lbs.)
Dimensions (L x W x H) Dimensi 体积	168x66x217mm (6-5/8"x2-5/8"x8-1/2")
Net Weight Berat Bersih 淨重	1.1 - 1.3kg (2.4 - 2.8lbs)
Work Amount (approx.) Jumlah Kerja 工作量	460 holes with BL1021B Drilling ø9mm Auger Bit, Melapi 30mm Thickness

HP333DSME RM 1,235 | **HP333DWAE** RM 972 | **HP333DWYE** RM 917 | **HP333DZ** 10mm (3/8") RM 407

Cordless Hammer Driver Drill
Tukul Pemutar Skru Bergerudi Tanpa Kord
充电式冲击螺丝起子电钻



• Increased motor power for higher speed and max tightening torque

Standard Equipment: Phillips Bit, Belt Clip

- DSME: 1x Speed Charger, 2x 4.0Ah Battery
- DWAE: 1x Standard Charger, 2x 2.0Ah Battery
- DWYE: 1x Standard Charger, 2x 1.5Ah Battery
- DZ: Without Charger, Battery & Carrying Case



*Not applicable for Z model

Capacity Kapasiti 能力	Steel: 10mm (3/8") Wood: 21mm (13/16") Masonry: 8mm (5/16")
Chuck Capacity Kapasiti Chuck 夹头能力	0.8 - 10mm (1/32 - 3/8")
Impacts Per Minute (IPM) Impak Per Minit 冲击数	High: 0 - 25,500 Low: 0 - 6,750
No Load Speed (RPM) Kelajuan Tanpa Beban 回转数	High: 0 - 1,700 Low: 0 - 450
Max Fastening Torque Maksimum Tenaga Pemutaran Pengancing 最快扭力	Hard: 30N-m (270in.lbs.) Soft: 14N-m (130in.lbs.)
Max Lock Torque Pemutaran Tenaga Maksimum 最大扭矩	28N-m (250 in.lbs.)
Dimensions (L x W x H) Dimensi 体积	193x66x212mm (7-5/8"x2-5/8"x8-3/8")
Net Weight Berat Bersih 淨重	1.1 - 1.3kg (2.4 - 2.9lbs.)

HP331DSME RM 1,235 | **HP331DWAE** RM 972 | **HP331DWYE** 10mm (3/8") RM 917

Cordless Hammer Driver Drill
Tukul Pemutar Skru Bergerudi Tanpa Kord
充电式冲击螺丝起子电钻

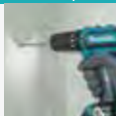

• High speed mode for speedy drilling

Standard Equipment: Phillips Bit, Belt Clip

- DSME: 1x Speed Charger, 2x 4.0Ah Battery
- DWAE: 1x Standard Charger, 2x 2.0Ah Battery
- DWYE: 1x Standard Charger, 2x 1.5Ah Battery



*Not applicable for Z model

Capacity Kapasiti 能力	Steel: 10mm (3/8") Wood: 21mm (13/16") Masonry: 8mm (5/16")
Impacts Per Minute (IPM) Impak Per Minit 冲击数	High: 0 - 25,500 Low: 0 - 6,750
No Load Speed (RPM) Kelajuan Tanpa Beban 回转数	High: 0 - 1,700 Low: 0 - 450
Max Fastening Torque Maksimum Tenaga Pemutaran Pengancing 最快扭力	Hard: 30N-m (270in.lbs.) Soft: 14N-m (130in.lbs.)
Max Lock Torque Pemutaran Tenaga Maksimum 最大扭矩	28N-m (250in.lbs.)
Dimensions (L x W x H) Dimensi 体积	201x66x209mm (7-7/8"x2-5/8"x8-1/4")
Net Weight Berat Bersih 淨重	1.1 - 1.3kg (2.5 - 2.9lbs)
Work Amount (approx.) Jumlah Kerja 工作量	350 holes with BL1021B Drilling ø9mm Auger Bit, Melapi 30mm Thickness

TD111DSME RM 1,510 | **TD111DWAE** RM 1,245 | **TD111DWYE** RM 1,190 | **TD111DZ** RM 680

Cordless Impact Driver
Pemutar Skru Impak Tanpa Kord
充电式冲击螺丝起子机

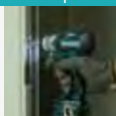

• 3-Mode operation: A-mode/ Hard mode/ Soft mode

Standard Equipment: Phillips Bit, Belt Clip

- DSME: 1x Speed Charger, 2x 4.0Ah Battery
- DWAE: 1x Standard Charger, 2x 2.0Ah Battery
- DWYE: 1x Standard Charger, 2x 1.5Ah Battery
- DZ: Without Charger, Battery & Carrying Case



*Not applicable for Z model



Capacity Kapasiti 能力	Machine Screw: M4 - M8mm (5/32" - 5/16") Standard Bolt: M5 - M14 (3/16" - 9/16") High Tensile Bolt: M5 - M12 (3/16" - 1/2") Coarse thread (in length): 22 - 90mm (7/8" - 3-1/2") 6.35mm (1/4")
Hex Shank Batang Heksagon 六角柄	
No Load Speed (RPM) Kelajuan Tanpa Beban 回转数	Hard: 0 - 3,000 Soft: 0 - 1,300
Impacts Per Minute (IPM) Impak Per Minit 冲击数	Hard: 0 - 3,900 Soft: 0 - 1,600
Max Fastening Torque Maksimum Tenaga Pemutaran Pengancing 最快扭力	135N-m (1,200in.lbs.)
Dimensions (L x W x H) Dimensi 体积	135x66x210mm (5-5/16"x2-5/8"x8-1/4")
Net Weight Berat Bersih 淨重	0.97 - 1.1kg (2.1 - 2.5lbs)
Work Amount (approx.) Jumlah Kerja 工作量	340 pcs with BL1021B Coarse Thread Wood Screw 45mm (Melapi)

* All list price shown are for reference only (exclude SST).

* Semua harga yang ditunjukkan adalah untuk rujukan sahaja (tidak termasuk SST). 所有显示的建议零售价仅供参考 (不包括SST)。

Cordless
Tanjap Kordless

LED Flashlight
Lampu Cahaya LED
LED 闪光灯

Vacuum Cleaner
Penyedut Vakuum
吸尘器

Drilling / Fastening
Gerudi / Pengancing
钻孔 / 起螺

Impact Drilling / Demolition
Gerudi / Demolisi
冲击钻孔 / 拆除

Cutting
Pemotongan
切割

Grinding / Sanding
Pengisar / Pasukan
打磨 / 砂光

Sawing
Gergaji
锯切

Planing / Routing
Pengaliran / Tumpang
刨平 / 开槽

Drivers / Torque
Penggerak / Tork
驱动 / 扭力

Outdoor Power Equipment
Alat Kuasa Luar
户外动力设备

Makita
MAKITA



TD110DSME RM 1,160 | **TD110DWAE** RM 895 | **TD110DWYE** RM 840 | **TD110DZ** RM 330

Cordless Impact Driver
Pemutar Skru Impak Tanpa Kord
充电式冲击螺丝起子机



- Compact and Lightweight

Standard Equipment: Phillips Bit, Belt Clip

- DSME: 1x Speed Charger, 2x 4.0Ah Battery
- DWAE: 1x Standard Charger, 2x 2.0Ah Battery
- DWYE: 1x Standard Charger, 2x 1.5Ah Battery
- DZ: Without Charger, Battery & Carrying Case



Capacity Kapasiti 能力	Machine Screw: M4 - M8mm (5/32" - 5/16") Standard Bolt: M5 - M12 (3/16" - 1/2") High Tensile Bolt: M5 - M10 (3/16" - 3/8") Coarse thread (in length): 22 - 90mm (7/8" - 3-1/2")
Hex Shank Balang Heksagon 六角柄	6.35mm (1/4")
No Load Speed (RPM) Kelajuan Tanpa Beban 回转数	0 - 2,600
Impacts Per Minute (IPM) Impak Per Minit 冲击数	0 - 3,500
Max Fastening Torque Maksimum Tenaga Pemutaran Pengancing 最快扭力	110N-m (970in.lbs.)
Dimensions (L x W x H) Dimensi 体积	153x66x204mm (6"x2-5/8"x8-1/8")
Net Weight Berat Bersih 淨重	1.0 - 1.2kg (2.3 - 2.6lbs)
Work Amount (approx.) Jumlah Kerja 工作量	250 pcs with BL1021B Coarse Thread Wood Screw 45mm (Melapi)

TW161DSME RM 1,422 | **TW161DWAE** RM 1,157 | **TW161DZ** 12.7mm (1/2") RM 593

Cordless Impact Wrench
Perengkuh Impak Tanpa Kord
充电式冲击套筒扳手



- Reverse Rotation Auto-Stop Mode stops in 0.2 seconds after loosened enough

Standard Equipment: Belt Clip

- DSME: 1x Speed Charger, 2x 4.0Ah Battery
- DWAE: 1x Standard Charger, 2x 2.0Ah Battery
- DZ: Without Charger, Battery & Carrying Case



Fastening Capacities Kapasiti 能力	Standard Bolt: M8 - M16 (5/16" - 5/8") High Tensile Bolt: M6 - M12 (1/4" - 1/2") 12.7mm (1/2")
Square Drive Balang Segi Empat 四方头	
No Load Speed (RPM) Kelajuan Tanpa Beban 回转数	Hard: 0 - 2,400 Soft: 0 - 1,300
Impacts Per Minute (IPM) Impak Per Minit 冲击数	Hard: 0 - 3,600 Soft: 0 - 2,000
Max Fastening Torque Maksimum Tenaga Pemutaran Pengancing 最快扭力	165N-m (122ft.lbs.)
Dimensions (L x W x H) Dimensi 体积	150x66x213mm (5-7/8"x2-5/8"x8-3/8")
Net Weight Berat Bersih 淨重	1.1 - 1.2kg (2.4 - 2.7lbs.)

TW160DZ 9.5mm (3/8") RM 593

Cordless Impact Wrench
Perengkuh Impak Tanpa Kord
充电式冲击套筒扳手



- 9.5mm (3/8") square drive fits most common automotive sockets

Standard Equipment: Belt Clip

- DZ: Without Charger & Battery

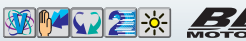

Fastening Capacities Kapasiti 能力	Standard Bolt: M8 - M16 (5/16" - 5/8") High Tensile Bolt: M6 - M12 (1/4" - 1/2") 9.5mm (3/8")
Square Drive Balang Segi Empat 四方头	
No Load Speed (RPM) Kelajuan Tanpa Beban 回转数	Hard: 0 - 2,400 Soft: 0 - 1,300
Impacts Per Minute (IPM) Impak Per Minit 冲击数	Hard: 0 - 3,600 Soft: 0 - 2,000
Max Fastening Torque Maksimum Tenaga Pemutaran Pengancing 最快扭力	160N-m (120ft.lbs.)
Dimensions (L x W x H) Dimensi 体积	144x66x213mm (5-5/8"x2-5/8"x8-3/8")
Net Weight Berat Bersih 淨重	1.0 - 1.2kg (2.2 - 2.6lbs.)

TW141DSME RM 1,202 | **TW141DWAE** RM 937 | **TW141DZ** 12.7mm (1/2") RM 372

Cordless Impact Wrench
Perengkuh Impak Tanpa Kord
充电式冲击套筒扳手



- Ultra compact design and lightweight

Standard Equipment: Belt Clip

- DSME: 1x Speed Charger, 2x 4.0Ah Battery
- DWAE: 1x Standard Charger, 2x 2.0Ah Battery
- DZ: Without Charger, Battery & Carrying Case



Fastening Capacities Kapasiti 能力	Standard Bolt: M8 - M16 (5/16" - 5/8") High Tensile Bolt: M6 - M12 (1/4" - 1/2") 12.7mm (1/2")
Square Drive Balang Segi Empat 四方头	
No Load Speed (RPM) Kelajuan Tanpa Beban 回转数	0 - 2,600
Impacts Per Minute (IPM) Impak Per Minit 冲击数	0 - 3,200
Max Fastening Torque Maksimum Tenaga Pemutaran Pengancing 最快扭力	145N-m (107ft.lbs.)
Dimensions (L x W x H) Dimensi 体积	168x66x205mm (6-5/8"x2-5/8"x8-1/8")
Net Weight Berat Bersih 淨重	1.1 - 1.2kg (2.4 - 2.7lbs.)

TW140DZ 9.5mm (3/8") RM 372

Cordless Impact Wrench
Perengkuh Impak Tanpa Kord
充电式冲击套筒扳手



- 9.5mm (3/8") square drive fits most common automotive sockets

Standard Equipment: Belt Clip

- DZ: Without Charger & Battery



Fastening Capacities Kapasiti 能力	Standard Bolt: M8 - M16 (5/16" - 5/8") High Tensile Bolt: M6 - M12 (1/4" - 1/2") 9.5mm (3/8")
Square Drive Balang Segi Empat 四方头	
No Load Speed (RPM) Kelajuan Tanpa Beban 回转数	0 - 2,600
Impacts Per Minute (IPM) Impak Per Minit 冲击数	0 - 3,200
Max Fastening Torque Maksimum Tenaga Pemutaran Pengancing 最快扭力	140N-m (1,240in.lbs.)
Dimensions (L x W x H) Dimensi 体积	161x66x205mm (6-3/8"x2-5/8"x8-1/8")
Net Weight Berat Bersih 淨重	1 - 1.2kg (2.3 - 2.7lbs.)
Work Amount (approx.) Jumlah Kerja 工作量	160 pcs with BL1021B High Tensile Bolt M12 Standard Fastening Torque at 100N.m

* All list price shown are for reference only (exclude SST).

* Semua harga yang ditunjukkan adalah untuk rujukan sahaja (tidak termasuk SST). 所有显示的建议零售价仅供参考 (不包括SST)。

Cordless
Tempat Masa

LED Flashlight
Lampu Sinar LED
LED LIGHT

Vacuum Cleaner
Penyedut Debu
VACUUM

Drilling / Fastening
Gali / Pasang
MIL / 螺絲

Impact Drilling / Demolition
Gali / Pasang
MIL / 螺絲

Impact Drilling / Demolition
Gali / Pasang
MIL / 螺絲

Cutting
Gali / Pasang
MIL / 螺絲

Grinding / Smoothing
Gali / Pasang
MIL / 螺絲

Sawing
Gali / Pasang
MIL / 螺絲

Planing / Routing
Gali / Pasang
MIL / 螺絲

Others
Lain-lain
LAIN-LAIN

Outdoor Power Equipment
Alatan Kuat Daya
ALATAN KUAT DAYA

Thakita
TENT

12V_{max}

CXT

Li-ion Ah 4.0 2.0 1.5

TW060DZ 6.35mm (1/4")
RM 372

Cordless Impact Wrench
Perengkuh Impak Tanpa Kord
充电式冲击套筒扳手

- Electric brake for increased operator safety



Standard Equipment: Belt Clip

- DZ: Without Charger & Battery



Fastening Capacities Kapasiti 能力	Standard Bolt: M8 - M12 (5/16" - 15/32")
Square Drive Batang Segi Empat 四方头	High Tensile Bolt: M6 - M10 (1/4" - 3/8")
No Load Speed (RPM) Kelajuan Tanpa Beban 回转数	0 - 2,600
Impacts Per Minute (IPM) Impak Per Minit 冲击数	0 - 3,200
Max Fastening Torque Maksimum Tenaga Pemutaran Pengancing 最快扭力	60N·m (530in.lbs.)
Dimensions (L x W x H) Dimensi 体积	161x66x205mm (6-3/8"x2-5/8"x8-1/8")
Net Weight Berat Bersih 淨重	1.0 - 1.2kg (2.2 - 2.6lbs.)

Cordless Ratchet Wrench

Perengkuh Ratchet Tanpa Kord 充电式棘轮扳手

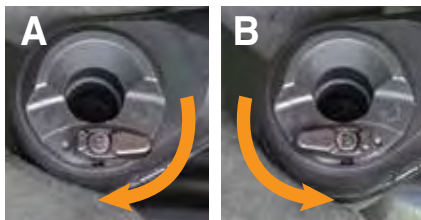

Max Fastening Torque
Tenaga Pemutaran Pengancing Maksimum 最快扭转
47.5N·m

Forward / Reverse rotation change
Turn the reversing lever to the A side for clockwise rotation or to the B side for counterclockwise rotation
Perubahan putaran maju / belakang 正转/反转变化



LED job light
Lampu kerja LED
LED工作灯

Switch lever
Tukar tuil
切换杆

Compatible with variable sockets with socket adapter
Sesuai dengan soket yang berubah-ubah dengan penyesuaian soket 与带有插座适配器的可变插座兼容



Accessories (Optional)
Aksesori 配件



Socket Adaptor 9.5mm (3/8")
Part No.191A50-3

Socket Adaptor 6.35mm (1/4")
Part No.191A51-1

Standard Equipment
Peralatan Standard
标准装备



Tool Bag (optional)
Part No. 832071-7

Able to tighten 13mm nut onto M8 threaded rod
Kipas swing automatik
自动档



13mm nut only

WR100DWA | WR100DZ 9.5mm (3/8")
RM1,605 | RM 1,222

Cordless Ratchet Wrench
Perengkuh Ratchet Tanpa Kord
充电式棘轮扳手

- Supplied with Two Socket Adaptors for Compatibility with a Variety of Sockets

Standard Equipment:
Socket Adaptor 9.5mm & 6.35mm

- DWA: 1x Standard Charger, 1x 2.0Ah Battery, 1x Tool Bag
- DZ: Without Charger & Battery



Capacity Kapasiti 能力	Standard Bolt: M5 - M12 (3/16" - 1/2")
Square Drive Kepala Segi Empat 方形头	High Tensile Bolt: M5 - M10 (3/16" - 3/8")
No Load Speed (RPM) Kelajuan Tanpa Beban 回转数	0 - 800
Max Fastening Torque Tenaga Pemutaran Pengancing Maksimum 最快扭转	47.5N·m (420in.lbs.)
Dimensions (L x W x H) Dimensi 体积	341x67x63mm (13-7/16"x2-5/8"x2-1/2")
Net Weight Berat Bersih 淨重	1.0 - 1.2kg (2.3 - 2.7lbs.)

* All list price shown are for reference only (exclude SST).

* Semua harga yang ditunjukkan adalah untuk rujukan sahaja (tidak termasuk SST). 所有显示的建议零售价仅供参考 (不包括SST)。

Cordless Impact Wrench
LED Flashlight
Vacuum Cleaner
Drilling / Fastening
Impact Drilling / Demolition
Cutting
Grinding / Sanding
Sawing
Planing / Routing
Others
Outdoor Power Equipment



12V_{max}

CXT

Li-ion Ah 4.0 2.0 1.5

HR166DSMJ RM 1,787	HR166DWAJ RM 1,523	HR166DZ 16mm (5/8") RM 957
------------------------------	------------------------------	--------------------------------------

Cordless Rotary Hammer
Tukul Putar Tanpa Kord
充电式电钻



2 modes



- 2-Mode operation for Rotation Only or Hammering with Rotation

Standard Equipment: Side Grip, Depth Gauge

- DSMJ: 1x Speed Charger, 2x 4.0Ah Battery, 1x Makpac Connector Box
- DWAJ: 1x Standard Charger, 2x 2.0Ah Battery, 1x Makpac Connector Box
- DZ: Without Charger, Battery & Carrying Case

Standard icons: Safety, Noise, Vibration, Light, Battery, etc.

BL MOTOR

Impact Energy Kekuatan Impak 单次最大冲击力	EPTA-Procedure 05/2009: 1.1J Our experimental conditions: 1.0J
Capacity Kapasiti 能力	Concrete: 16mm (5/8") Steel: 10mm (3/8") Wood: 13mm (1/2")
Impacts Per Minute (IPM) Impak Per Minit 冲击数	0 - 4,800
No Load Speed (RPM) Kelajuan Tanpa Beban 回转数	0 - 680
Dimensions (L x W x H) Dimensi 体积	BL1021B: 250x74x187mm (9-7/8"x2-15/16"x7-3/8")
Net Weight Berat Bersih 净重	1.8 - 2.4kg (4.1 - 5.4lbs)
Work Amount (approx.) Jumlah Kerja 工作量	42 holes with BL1021B Masonry drill ø6mm (Concrete 40N/mm ² Depth 40mm)

QR Code: HR166D

VIDEO CLIP
Models and specs may vary by country.

HR140DWYE1 14mm (9/16") RM 1,787
--

Cordless Rotary Hammer
Tukul Putar Tanpa Kord
充电式电钻



2 modes



Accessories Set For HR140DWYE1 only

- 2-Mode operation for Rotation Only or Hammering with Rotation

Standard Equipment: Side Grip, Depth Gauge

- DWYE1: 1x Standard Charger, 2x 1.5Ah Battery, Accessories Set

Standard icons: Safety, Noise, Vibration, Light, Battery, etc.

BL MOTOR

Impact Energy Kekuatan Impak 单次最大冲击力	EPTA-Procedure 05/2009: 1.0J Our experimental conditions: 0.9J
Capacity Kapasiti 能力	Concrete: 14mm (9/16") Steel: 10mm (3/8") Wood: 13mm (1/2")
Impacts Per Minute (IPM) Impak Per Minit 冲击数	0 - 4,900
No Load Speed (RPM) Kelajuan Tanpa Beban 回转数	0 - 850
Dimensions (L x W x H) Dimensi 体积	BL1021B: 246x74x179mm (9-11/16"x2-15/16"x7") BL1041B: 246x74x198mm (9-11/16"x2-15/16"x7-3/4")
Net Weight Berat Bersih 净重	1.9 - 2.6kg (4.3 - 5.6lbs)
Work Amount (approx.) Jumlah Kerja 工作量	32 holes with BL1021B Masonry drill ø6mm (Concrete 40N/mm ² Depth 40mm)

TL064DSME RM 1,923	TL064DWAJ RM 1,658	TL064DZ RM 1,095
------------------------------	------------------------------	----------------------------

Cordless Angle Impact Driver
Pemutar Skru Impak Sudut Tanpa Kord
充电式角向冲击螺丝起子机



- Compact & lightweight for fastening and loosening in tight spaces

Standard Equipment: Phillips Bit, Belt Clip

- DSME: 1x Speed Charger, 2x 4.0Ah Battery
- DWAJ: 1x Standard Charger, 2x 2.0Ah Battery
- DZ: Without Charger, Battery & Carrying Case

Standard icons: Safety, Noise, Vibration, Light, Battery, etc.

BL MOTOR

Capacity Kapasiti 能力	Machine Screw: M4 - M8 (5/32" - 5/16") Standard Bolt: M4 - M12 (5/32" - 1/2") High Tensile Bolt: M4 - M8 (5/32" - 5/16") Coarse thread (in length): 22 - 75mm (7/8" - 2-31/32") 6.35mm (1/4")
Hex Shank Balang Heksagon 六角柄	
No Load Speed (RPM) Kelajuan Tanpa Beban 回转数	0 - 2,000
Impacts Per Minute (IPM) Impak Per Minit 冲击数	0 - 3,000
Max Fastening Torque Maksimum Tenaga Pemutaran Pengancing 最快扭力	60N-m (530in.lbs.)
Dimensions (L x W x H) Dimensi 体积	361x66x86mm (14-1/4"x2-5/8"x3-3/8")
Net Weight Berat Bersih 净重	1.2 - 1.6kg (2.7 - 3.6lbs)
Work Amount (approx.) Jumlah Kerja 工作量	933 pcs with BL1021B Machine Screw M8 x 16mm

TL065DSME RM 2,010	TL065DWAJ RM 1,747	TL065DZ RM 1,182
------------------------------	------------------------------	----------------------------

Cordless Angle Impact Wrench
Perengkuh Impak Sudut Tanpa Kord
充电式角向冲击套筒扳手



- Compact & lightweight for fastening and loosening in tight spaces

Standard Equipment: Belt Clip

- DSME: 1x Speed Charger, 2x 4.0Ah Battery
- DWAJ: 1x Standard Charger, 2x 2.0Ah Battery
- DZ: Without Charger, Battery & Carrying Case

Standard icons: Safety, Noise, Vibration, Light, Battery, etc.

BL MOTOR

Capacity Kapasiti 能力	Standard Bolt: M4 - M12 (5/32" - 1/2") High Tensile Bolt: M4 - M8 (5/32" - 5/16") 9.5mm (3/8")
Square Drive Batang Segi Empat 四方头	
No Load Speed (RPM) Kelajuan Tanpa Beban 回转数	0 - 2,000
Impacts Per Minute (IPM) Impak Per Minit 冲击数	0 - 3,000
Max Fastening Torque Maksimum Tenaga Pemutaran Pengancing 最快扭力	60N-m (530in.lbs.)
Dimensions (L x W x H) Dimensi 体积	361x66x86mm (14-1/4"x2-5/8"x3-3/8")
Net Weight Berat Bersih 净重	1.2 - 1.6kg (2.7 - 3.6lbs)
Work Amount (approx.) Jumlah Kerja 工作量	933 pcs with BL1021B Machine Screw M8 x 16mm

DA332DWAJ RM 1,223	DA332DZ 10mm (3/8") RM 658
------------------------------	--------------------------------------

Cordless Angle Drill
Gerudi Sudut Tanpa Kord
充电式角向电钻



- Up to 40% faster drilling and 380% longer runtime**

Standard Equipment: Chuck Key, Chuck Key Holder, Phillips Bit, Belt Clip

- DWAJ: 1x Standard Charger, 2x 2.0Ah Battery
- DZ: Without Charger, Battery & Carrying Case

Standard icons: Safety, Noise, Vibration, Light, Battery, etc.

BL MOTOR

Capacity Kapasiti 能力	Steel: 10mm (3/8") Wood: 12mm (1/2")
No Load Speed (RPM) Kelajuan Tanpa Beban 回转数	0 - 1,100
Head Height Ketinggian Kepala 高度	63mm (2-1/2")
Center Height Pusat Tinggi 中心高度	23.5mm (15/16")
Dimensions (L x W x H) Dimensi 体积	BL1021B: 313x68x86mm (12-3/8"x2-11/16"x3-3/8") BL1041B: 332x68x86mm (13-1/8"x2-11/16"x3-3/8")
Net Weight Berat Bersih 净重	1.2 - 1.3kg (2.6 - 2.9lbs)
Work Amount (approx.) Jumlah Kerja 工作量	600 pcs with BL1021B Wood Screw ø4.1 x 38mm

* All list price shown are for reference only (exclude SST).
* Semua harga yang ditunjukkan adalah untuk rujukan sahaja (tidak termasuk SST). 所有显示的建议零售价仅供参考 (不包括SST)。

Cordless
Tempat Kerja Tanpa Kord

LED Flashlight
Lampu Senter LED

Vacuum Cleaner
Penyedut Vakuum

Drilling / Fastening
Gergaji / Pengancing

Impact Drilling / Demolition
Gergaji / Pencah

Cutting
Pemotong

Grinding / Smoothing
Gergaji / Halus

Sawing
Gergaji

Planing / Routing
Penghalus / Pengancing

Others
Lain-lain

Outdoor Power Equipment
Alat Kuasa Luar

Makita
100% ORIGINAL

12V_{max}

CXT

Li-ion Ah 4.0 2.0 1.5

TM30DWAE | **TM30DWAEX1** | **TM30DZ**
 RM 1,087 | RM 1,200 | RM 522

Cordless Multi Tool
 Mesin Pemotong Berbilang Fungsi
 Tanpa Kord
 充电式多功能切割打磨机



• 12 Angle settings at every 30° from 0° to 360°

Standard Equipment: Hex Wrench

- DWAE: 1x Standard Charger, 2x 2.0Ah Battery
- DWAEEX1: 1x Standard Charger, 2x 2.0Ah Battery, Accessories Set (Plunge Cut Saw Blade 28 (B-21353), Segment Saw Blade 85 (B-21325), Sanding Pad (B-46202))
- DZ: Without Charger, Battery & Carrying Case



*Not applicable for Z model



Oscillations Per Minute (OPM) Kelajuan Ayunan 摆动速度	6,000 - 20,000
Oscillation Angle Sudut Ayunan 摆动角度	Left: 1.6° Right: 1.6° Total: 3.2°
Dimensions (L x W x H) Dimensi 体积	277x65x98mm (10-7/8"x2-9/16"x3-7/8")
Net Weight Berat Bersih 淨重	1.1 - 1.3kg (2.3 - 2.9lbs)
Continuous Usage Time (approx.) Masa Penggunaan Berterusan 连续使用时间	16 min with BL1021B

CP100DWA | **CP100DZ**
 RM 885 | RM 502

Cordless Multi Cutter
 Pemotong Pelbagai Fungsi
 Tanpa Kord
 充电式多功能电剪



• Cuts thin and thick material up to 6mm such as cardboard, carpet, fabrics, leather, CD, DVD & Blu-ray

Standard Equipment: Blade

- DWA: 1x Standard Charger, 1x 2.0Ah Battery, Tool Bag
- DZ: Without Charger & Battery



VIDEO CLIP
 Models and specs may vary by country

Max Cutting Capacity Kapasiti Pemotongan Maksimum 最大切割能力	6mm (1/4")
No Load Speed (RPM) Kelajuan Tanpa Beban 回转速数	300
Dimensions (L x W x H) Dimensi 体积	BL1021B: 272x66x120mm (10-3/4"x2-5/8"x4-3/4") BL1041B: 291x66x121mm (11-1/2"x2-5/8"x4-3/4")
Net Weight Berat Bersih 淨重	0.72 - 0.88kg (1.6 - 1.9lbs)
Work Amount (approx.) Jumlah Kerja 工作量	800 m with BL1021B Cardboard Carton 5mm (T) 500mm (L)

Cordless Threaded Rod Cutter

Pemotong Batang Keluli Tanpa Kord 充电式螺纹杆切割机

Lightweight
 Ringan 轻量
2.8kg
 with BL1041B
 4.0Ah Battery

Maximum Cutting Capacity
 Kapasiti Pemotongan Maksimum 最大切割能力
Mild Steel: M10
Stainless Steel: W3/8



Guide scale
 Panjang hos 软管长度

Compact motor section with overall length of 177mm
 Bahagian motor padat dengan panjang keseluruhan 177mm 紧凑的电机全长177mm

Clean cut surface Burr-free cuts allow for easy nut tightening
 Permukaan pemotong yang bersih untuk mengetatkan skru dengan mudah 干净的切割表面易于拧紧螺母

SC103DZJ
 RM 6,083

Cordless Threaded Rod Cutter
 Pemotong Batang Keluli Tanpa Kord
 充电式螺纹杆切割机



Standard Equipment: Cutter Blade W3/8 (199081-0), Hex socket head bolt, Blade Cover, Depth Gauge, Thumb screw, Hex Wrench

- DZJ: With 1x Makpac Connector Box, Without Charger & Battery



*Not applicable for Z model



Max Cutting Capacity Kapasiti Pemotongan Maksimum 最大切割能力	Mild Steel: M10 Stainless Steel: W3/8
Min. Cutting Length Panjang Pemotongan Minimum 最小切割长度	20mm (13/16")
Dimensions (L x W x H) Dimensi 体积	180x107x289mm (7-1/8"x4-1/4"x11-3/8")
Net Weight Berat Bersih 淨重	2.7 - 2.8kg (6.0 - 6.2lbs.)
Work Amount (approx.) Jumlah Kerja 工作量	550 pcs with BL1041B Mild Steel M10

* All list price shown are for reference only (exclude SST).

* Semua harga yang ditunjukkan adalah untuk rujukan sahaja (tidak termasuk SST). 所有显示的建议零售价仅供参考 (不包括SST)。

Cordless Lampu Kerja LED
 LED Flashlight
 Vacuum Cleaner
 Vacuum Cleaner
 Drilling / Fastening
 Impact Drilling / Demolition
 Cutting
 Grinding / Sanding
 Sawing
 Planing / Routing
 Drivers





PV301DZ

RM 1,550

Cordless Sander Polisher

Penggilap Tanpa Kord
充电式打蜡抛光机



- Easy to change Hook & Loop style backing pad mainly for polishing

Standard Equipment: Side Grip, Pad 75 (743125-4), Pad 50 (743124-6), Adapter (743126-2), Sponge Pad Rough (191N90-9), Sponge Pad Medium (191N91-7), Wool Pad (191N92-5)

• DZ: Without Charger & Battery



Pad / Disc Diameter Diameter Pad / Cakera 垫/盘直径	Hook & Loop Style: 80mm (3-1/8") Twist-On / Twist-Off Style: 50mm (2")
Backing Pad Diameter Diameter Pad 衬垫直径	Hook & Loop Style: 75mm (2-15/16") Twist-On / Twist-Off Style: 46mm (1-13/16")
Head Length Panjang Kepala 头长度	127mm (5")
No Load Speed (RPM) Kelajuan Tanpa Beban 回转数	Polishing: 0 - 2,800 Sanding: 0 - 9,500
Dimensions (L x W x H) Dimensi 体积	137x67x231mm (5-3/8x2-5/8x9-1/8")
Net Weight Berat Bersih 净重	1.1 - 1.2kg (2.4 - 2.6lbs.)
Continuous Usage Time (approx.) Masa Penggunaan Berterusan 连续使用时间	18 min with BL1041B

CC301DWME

RM 1,513

CC301DWAE

RM 1,332

CC301DZ 85mm (3-3/8")

RM 765

Cordless Cutter

Pemotong Tanpa Kord
充电式切割机



- Designed for cutting glass and ceramic tile

Standard Equipment: Diamond Wheel, Water Supply Tank Assembly, Hex Wrench

- DWME: 1x Standard Charger, 2x 4.0Ah Battery
- DWAE: 1x Standard Charger, 2x 2.0Ah Battery
- DZ: Without Charger, Battery & Carrying Case



Blade Diameter Diameter Bilah 锯片直径	85mm (3-3/8")
Max Cutting Capacity Kapasiti Pemotongan Maksimum 最大切割能力	90°: 25.5mm (1") 45°: 16.5mm (5/8")
No Load Speed (RPM) Kelajuan Tanpa Beban 回转数	1,600
Tank Capacity Kapasiti Tangki 水箱容量	Water : 0.5L
Dimensions (L x W x H) Dimensi 体积	313x170x125mm (12-3/8"x6-11/16"x4-7/8")
Net Weight Berat Bersih 净重	1.9kg (4.1lbs)
Work Amount (approx.) Jumlah Kerja 工作量	1.5 pcs with BL1021B Diamond Blade, Glass 10 x 300mm

HS301DSME

RM 1,368

HS301DWAE

RM 1,105

HS301DZ 85mm (3-3/8")

RM 540

Cordless Circular Saw

Gergaji Piring Tanpa Kord
充电式圆锯



- Fast cutting of plywood, MDF, pegboard, particleboard, melamine, drywall and more

Standard Equipment: TCT Saw Blade (B-14607), Hex Wrench

- DSME: 1x Speed Charger, 2x 4.0Ah Battery
- DWAE: 1x Standard Charger, 2x 2.0Ah Battery
- DZ: Without Charger, Battery & Carrying Case

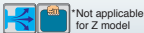

Blade Diameter Diameter Bilah 锯片直径	85mm (3-3/8")
Max Cutting Capacity Kapasiti Pemotongan Maksimum 最大切割能力	90°: 25.5mm (1") 45°: 16.5mm (5/8")
No Load Speed (RPM) Kelajuan Tanpa Beban 回转数	1,500
Dimensions (L x W x H) Dimensi 体积	313x170x155mm (12-3/8"x6-11/16"x6-1/8")
Net Weight Berat Bersih 净重	1.6 - 1.7kg (3.5 - 3.8lbs)
Work Amount (approx.) Jumlah Kerja 工作量	140 cuts with BL1021B Sawing (SPF 1"x4" 0 Degree Cut)

SD100DWAJ

RM 1,905

SD100DZ

RM 1,340

Cordless Drywall Saw

Gergaji Drywall Tanpa Kord
充电式石膏板切割机



- Ideal for cutting holes in drywalls when setting ceiling lights, air vents etc

Standard Equipment: Blade, Blade Cover, Base Cover, Hex Wrench

- DWAJ: 1x Standard Charger, 2x 2.0Ah Battery, 1x Makpac Connector Box
- DZ: Without Charger, Battery & Carrying Case



Strokes Per Minute (SPM) Kelajuan Strok 冲程速度	0 - 6,000
Length of Stroke Panjang Strok 冲程长度	6mm (1/4")
Capacity Kapasiti 能力	Drywall: 30mm (1-3/16") Wood: 15mm (9/16")
Dimensions (L x W x H) Dimensi 体积	239x79x266mm (9-3/8"x3-1/8"x10-1/2")
Net Weight Berat Bersih 净重	1.4 - 1.6kg (3.2 - 3.5lbs)
Work Amount (approx.) Jumlah Kerja 工作量	50 m with BL1021B Cutting (Gypsum Board Thickness 9.5mm/ 2ply)

JV101DWAE

RM 1,050

JV101DWYE

RM 995

JV101DZ

RM 485

Cordless Jig Saw

Gergaji Jig Tanpa Kord
充电式线锯机

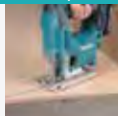

- Aluminum die-cast base adjusts from 0°-45° right to left

Standard Equipment: Jig Saw Blade B-10 (A-85628), Hex Wrench

- DWAE: 1x Standard Charger, 2x 2.0Ah Battery
- DWYE: 1x Standard Charger, 2x 1.5Ah Battery
- DZ: Without Charger, Battery & Carrying Case



Max Cutting Capacity at 90° Kapasiti Pemotongan Maksimum 最大切割能力	Wood: 65mm (2-9/16") Aluminum: 4mm (5/32") Mild Steel: 2mm (1/16")
Length of Stroke Panjang Strok 冲程长度	18mm (11/16")
Strokes Per Minute (SPM) Kelajuan Strok 冲程速度	0-2,900
Dimensions (L x W x H) Dimensi 体积	232x76x196mm (9-1/8"x3"x7-3/4")
Net Weight Berat Bersih 净重	1.8 - 1.9kg (3.9 - 4.3lbs)
Work Amount (approx.) Jumlah Kerja 工作量	60 pcs with BL1021B Sawing (Plywood 300mm Long x 12mm thickness)

* All list price shown are for reference only (exclude SST).

* Semua harga yang ditunjukkan adalah untuk rujukan sahaja (tidak termasuk SST). 所有显示的建议零售价仅供参考 (不包括SST)。





JV103DSMJ | **JV103DWAJ** | **JV103DZ**
 RM 1,838 | RM 1,573 | RM 1,008

Cordless Jig Saw
 Gergaji Jig Tanpa Kord
 充电式线锯机



• Up to 2.2X Faster Cutting & 2.2X Longer Runtime**

Standard Equipment:

- Jig Saw Blade B-10 (A-85628), Hex Wrench
- DSMJ: 1x Speed Charger, 2x 4.0Ah Battery, 1x Makpac Connector Box
- DWAJ: 1x Standard Charger, 2x 2.0Ah Battery, 1x Makpac Connector Box
- DZ: Without Charger, Battery & Carrying Case



MODELS AND SPECS MAY VARY BY COUNTRY



*Not applicable for Z model



Max Cutting Capacity at 90° Kapasiti Pemotongan Maksimum 最大切割能力	Wood: 90mm (3-1/2") Aluminum: 20mm (13/16") Mild Steel: 10mm (3/8")
Length of Stroke Panjang Strok 冲程长度	23mm (7/8")
Strokes Per Minute (SPM) Kelajuan Strok 冲程速度	800 - 3,000
Dimensions (L x W x H) Dimensi 体积	237x76x206mm (9-3/8"x3"x8-1/8")
Net Weight Berat Bersih 淨重	1.9 - 2.0kg (4.1 - 4.4lbs)
Work Amount (approx.) Jumlah Kerja 工作量	90 pcs with BL1021B Sawing (Plywood 300mm Long x 12mm thickness)

JV102DZ
 RM 1,008

Cordless Jig Saw
 Gergaji Jig Tanpa Kord
 充电式线锯机



• Up to 2.2X Faster Cutting & 2.2X Longer Runtime**

Standard Equipment:

- Jig Saw Blade B-10 (A-85628), Hex Wrench
- DZ : Without Charger & Battery



MODELS AND SPECS MAY VARY BY COUNTRY



*Not applicable for Z model



Max Cutting Capacity at 90° Kapasiti Pemotongan Maksimum 最大切割能力	Wood: 90mm (3-1/2") Aluminum: 20mm (13/16") Mild Steel: 10mm (3/8")
Length of Stroke Panjang Strok 冲程长度	23mm (7/8")
Strokes Per Minute (SPM) Kelajuan Strok 冲程速度	800 - 3,000
Dimensions (L x W x H) Dimensi 体积	237x76x186mm (9-3/8"x3"x7-3/8")
Net Weight Berat Bersih 淨重	1.8 - 1.9kg (3.9 - 4.2lbs)
Work Amount (approx.) Jumlah Kerja 工作量	290 pcs with BL1021B Sawing (Plywood 300mm Long x 12mm thickness)

PT354DZ
 RM 2,378

Cordless Pin Nailer
 Mesin Pemaku Tanpa Kord
 充电式打钉机



• Ergonomically designed handle with soft grip provides increased comfort

Standard Equipment: Nose Adapter, Safety Goggles, Belt Clip, Hex Wrench

- DZ: Without Charger & Battery



Capacity Kapasiti 能力	Length: 15, 18, 25, 30, 35mm (5/8", 11/16", 1", 1-3/16", 1-3/8") Dia.: 0.6mm (1/32") Gauge: 23Ga 120
Magazine Capacity Bilangan Staples 装订个数	120
Dimensions (L x W x H) Dimensi 体积	231x66x226mm (9-1/8"x2-5/8"x8-7/8")
Net Weight Berat Bersih 淨重	1.8 - 2.0kg (4.0 - 4.4lbs)
Work Amount (approx.) Jumlah Kerja 工作量	1333 pcs with BL1021B Pin nail

Accessories (optional)			
Description	Size	Pcs/ Box	Part No.
Pin Nail 18mm (11/16")	P18	10,000	F-31825
Pin Nail 25mm (1")	P25	10,000	F-31838
Pin Nail 30mm (1-3/16")	P30	10,000	F-31841
Pin Nail 35mm (1-3/8")	P35	10,000	F-31854

CG100DZA
 RM 1,383

Cordless Caulking Gun
 Alat Tembak Silikon Tanpa Kord
 充电式填缝枪



• 5 Speed dial optimizes flow rate 0 - 28mm/sec

Standard Equipment: Holder, Holder Joint, Piston, Rack 42, Safety Goggles

- DZA: Without Charger & Battery



MODELS AND SPECS MAY VARY BY COUNTRY

Max Dispensing Force Tujahan Maksimum 最大推力	5,000N (1,100lbs)
No Load Speed Kelajuan Tanpa Beban 回转数	0 - 28mm/sec. (0 - 66in/min.)
Holder Size Kapasiti 容量	300mL (Optional Accessories 600mL, 800mL Holder)
Dimensions (L x W x H) Dimensi 体积	404x108x259mm (15-7/8"x4-1/4"x10-1/4")
Net Weight Berat Bersih 淨重	1.9 - 2.6kg (4.2 - 5.8lbs)
Work Amount (approx.) Jumlah Kerja 工作量	150 pcs with BL1016 300ml silicon sealant

JR105DWAJ | **JR105DZ**
 RM 1,070 | RM 505

Cordless Recipro Saw
 Gergaji Resipro Tanpa Kord
 充电式往复锯

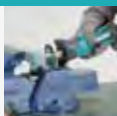

• Cuts PVC, ABS pipe, EMT, drywall, wood & more

Standard Equipment: Hex Wrench, Recipro Saw Blades 2pcs (B-20404 & B-20432)

- DWAE: 1x Standard Charger, 2x 2.0Ah Battery
- DZ: Without Charger, Battery & Carrying Case



*Not applicable for Z model

Length of Stroke Panjang Strok 冲程长度	13mm (1/2")
Strokes Per Minute (SPM) Kelajuan Strok 冲程速度	0 - 3,300
Capacity Kapasiti 能力	Pipe: 50mm (2") Wood: 50mm (2")
Dimensions (L x W x H) Dimensi 体积	376x66x186mm (14-3/4"x2-5/8"x7-3/8")
Net Weight Berat Bersih 淨重	1.3 - 1.5kg (2.9 - 3.2lbs)
Work Amount (approx.) Jumlah Kerja 工作量	45 pcs with BL1021B Cutting (PVC plastic hose 48mm)

* All list price shown are for reference only (exclude SST).

* Semua harga yang ditunjukkan adalah untuk rujukan sahaja (tidak termasuk SST). 所有显示的建议零售价仅供参考 (不包括SST)。

Cordless
LED Flashlight
Vacuum Cleaner
Drilling / Fastening
Impact Drilling / Demolition
Cutting
Grinding / Sanding
Sawing
Planing / Routing
Others
Outdoor Power Equipment



12V_{max}

CXT

Li-ion Ah 4.0 2.0 1.5



*Masa Penggunaan Berterusan
连续使用时间
Continuous Usage Time with BL1016N (Low Speed)
45min
(approx.)
* Continuous Usage Time/Work Amount: Actual performance may vary based on application.
* Masa Penggunaan Berterusan/ Jumlah Kerja: Prestasi sebenar mungkin berbeza bergantung kepada aplikasi.
* 连续使用时间/工作量: 实际使用连续使用时间会因应用而异。

Net Weight
Berat Bersih 淨重
1.4kg
with BL1016 1.5Ah Battery & Nozzle assembly

Net Weight
Berat Bersih 淨重
1.4kg
with BL1016 1.5Ah Battery & Nozzle assembly

UB100D is supplied with a **standard nozzle** for general blowing applications
UB100D dibekalkan dengan muncung standard untuk aplikasi umum
UB100D随附标准喷嘴, 适用于一般的吹除应用



UB101D is supplied with a **garden nozzle** for blowing fallen leaves
UB101D dibekalkan dengan muncung yang sesuai untuk menghembus daun yang gugur
UB101D随附花园喷嘴, 用于吹除落叶



UB101DZ
RM 500

Cordless Blower
Mesin Penghembus Angin Tanpa Kord
充电式吹风机

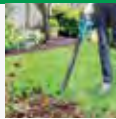

- Zero emissions and reduced maintenance; no need for gas or oil

Standard Equipment: Garden Nozzle (191G09-6)

• DZ: Without Charger & Battery



NEW
BARU | 新



Max Air Volume Isipadu Angin Maksimum 最大风量	2.6m ³ /min
Max Air Velocity Velositi Angin Maksimum 最大风速	56m/s
Avg. Air Velocity Kelajuan Angin Purata 平均风速	45m/s
No Load Speed (RPM) Kelajuan Tanpa Beban 回转数	0 - 15,800
Dimensions (L x W x H) Dimensi 体积	849x155x184mm (33-1/2x6-1/8x7-1/4")
Net Weight Berat Bersih 淨重	1.4 - 1.9kg (3.1 - 4.2lbs.)
Continuous Usage Time (approx.) Masa Penggunaan Berterusan 连续使用时间	Low: 45min Med: 20min High: 8min with BL1016

UB100DZ
RM 382

Cordless Blower
Mesin Penghembus Angin Tanpa Kord
充电式吹风机



- Zero emissions and reduced maintenance; no need for gas or oil

Standard Equipment: Nozzle Assembly (123245-4)

• DZ: Without Charger & Battery



NEW
BARU | 新



Max Air Volume Isipadu Angin Maksimum 最大风量	2.6m ³ /min
Max Air Velocity Velositi Angin Maksimum 最大风速	75m/s
Avg. Air Velocity Kelajuan Angin Purata 平均风速	62m/s
Max Sealed Suction Sedutan Terkedap 最大密封吸力	4.0kPa
No Load Speed (RPM) Kelajuan Tanpa Beban 回转数	0 - 15,800
Dimensions (L x W x H) Dimensi 体积	505x155x184mm (19-7/8x6-1/8x7-1/4")
Net Weight Berat Bersih 淨重	1.4 - 1.9kg (3.1 - 4.2lbs.)
Continuous Usage Time (approx.) Masa Penggunaan Berterusan 连续使用时间	Low: 45min Med: 20min High: 8min with BL1016

* All list price shown are for reference only (exclude SST).

* Semua harga yang ditunjukkan adalah untuk rujukan sahaja (tidak termasuk SST). 所有显示的建议零售价仅供参考 (不包括SST)。

Cordless
Tempat Kerja Tanpa Kord

LED Flashlight
Lampu Sinar LED
- LED BRIGHT

Vacuum Cleaner
Penyedut Vakuum
- 2.5L

Drilling / Fastening
Gergasi / Pengikat
- 1/2" - 3/8"

Impact Drilling / Demolition
Gergasi / Pecah
- 1/2" - 3/8"

Cutting
Pemotong
- 1/2"

Grinding / Smoothing
Gergasi / Mulus
- 1/2"

Sawing
Gergasi
- 1/2"

Planing / Routing
Papan / Trogam
- 1/2" - 3/8"

Others
Lain-lain
- 1/2"

Outdoor Power Equipment
Alatan Kuat Daya Luar
- 1/2"





UH353DWA 350mm (13-3/4")
RM 1,095

Cordless Hedge Trimmer
Pemangkas Tanaman Pagar
Tanpa Kord
充电式篱笆修剪机

- Lightweight. Low Vibration. Low Noise

Standard Equipment: Blade Cover

- DWA: 1x Standard Charger, 1x 2.0Ah Battery



Blade Length Panjang bilah 刀片长度	350mm (13-3/4")
Tooth Spacing Selang Gigi 牙齿间隔	28mm (1-1/8")
Max Cutting Capacity Kapasiti Pemotongan Maksimum 最大切割能力	15mm (9/16")
Strokes Per Minute (SPM) Kelajuan Strok 冲程速度	3,300
Dimensions (L x W x H) Dimensi 体积	693x175x165mm (27-1/4"x6-7/8"x6-1/2")
Net Weight Berat Bersih 淨重	1.9 - 2.1 kg (4.2 - 4.5 lbs.)
Continuous Usage Time Masa Penggunaan Berterusan 连续使用时间	40 min with BL1021B

UH201DWAX | **UH201DZ** 200mm (7-7/8")
RM 915 | RM 450

Cordless Hedge Trimmer
Pemangkas Tanaman Pagar
Tanpa Kord
充电式篱笆修剪机

- Dual blade action cuts quickly with a shearing effect

Standard Equipment: Blade Cover (458342-0),
Chip Receiver (198401-5)

- DWAX: 1x Standard Charger, 1x 2.0Ah Battery,
1x Grass Shear Blade (195267-4), 1x Grass Receiver (457426-1)
- DZ: Without Charger & Battery



Blade Length Panjang Bilah 刀片长度	200mm (7-7/8")
Tooth Spacing Selang Gigi 牙齿间隔	26mm (1")
Strokes Per Minute (SPM) Kelajuan Strok 冲程速度	2,500
Dimensions (L x W x H) Dimensi 体积	504x120x131mm (19-7/8"x4-3/4"x5-1/8")
Net Weight Berat Bersih 淨重	1.3 - 1.5kg (2.8 - 3.3lbs)
Continuous Usage Time (approx.) Masa Penggunaan Berterusan 连续使用时间	45 min with BL1021B

UM600DWA | **UM600DZ** 160mm (6-5/16")
RM 940 | RM 557

Cordless Grass Shear
Pemotong Rumput Tanpa Kord
充电式割草机

- 2 in 1: Both trimmer blade and shear blade can be attached

Standard Equipment: Grass Receiver, Blade Cover

- DWA: 1x Standard Charger, 1x 2.0Ah Battery
- DZ: Without Charger & Battery



Cutting Width Lebar Keratan 切割宽度	160mm (6-5/16")
Depth Adjustment Pelarasn Kedalaman 深度调整	15mm (9/16") 20mm (13/16") 25mm (1")
Strokes Per Minute (SPM) Kelajuan Strok 冲程速度	2,500
Dimensions (L x W x H) Dimensi 体积	329x177x131mm (13"x7"x5-1/8")
Net Weight Berat Bersih 淨重	1.3 - 1.5kg (2.8 - 3.3lbs)
Continuous Usage Time (approx.) Masa Penggunaan Berterusan 连续使用时间	45 min with BL1021B

UR100DSME | **UR100DZ**
RM 1,457 | RM 628

Cordless Grass Trimmer
Pemotong Rumput tanpa Kord
充电式割草机

- Well balanced design with fully adjustable features to suit any operator

Standard Equipment: Band Assembly, Nylon Cutting Head (198853-0),
Nylon Cord, Accessory Bag, Hex Wrench

- DSME: 1x Speed Charger, 2x 4.0Ah Battery
- DZ: Without Charger & Battery



Cutting Width Lebar Keratan 切割宽度	Nylon Cutting Head: 260mm (10") Plastic Blade: 230mm (9")
No Load Speed (RPM) Kelajuan Tanpa Beban 回转数	Nylon Cutting Head: 9,000 Plastic Blade: 10,000
Spindle Size Saiz Spindel 主轴尺寸	M8 x 1.25RH
Dimensions (L x W x H) Dimensi 体积	835 - 1,185x267x210 - 315mm (32-7/8 - 46-2/3"x10-1/2"x8-1/4 - 12-1/3")
Net Weight Berat Bersih 淨重	2.1 - 2.3kg (4.4 - 4.9lbs.)
Continuous Usage Time (approx.) Masa Penggunaan Berterusan 连续使用时间	27 min with BL1021B

MP100DZ
RM 532

Cordless Inflator
Inflator Tanpa Kord
充电式打气机

- Inflates the Tires of Cars, Bikes, Sport Balls, etc

Standard Equipment: British Adapter,
French Adapter, Ball Adapter,
Swim Ring Adapter

- DZ: Without Charger & Battery



VIDEO CLIP
Models and specs may vary by country



Max Air Pressure Udara Tekanan Maksimum 最大气压	830kPa (121 PSI) [8.3 bar]
Air Discharge Amount Pelepasan Udara 空气排放量	200kPa: 10L/min
Hose Length Panjang Hos 软管长度	65cm (25-1/2")
Dimensions (L x W x H) Dimensi 体积	235x74x173mm (9-1/4"x2-15/16"x6-13/16")
Net Weight Berat Bersih 淨重	1.2 - 1.3kg (2.6 - 3.0lbs.)
Work Amount (approx.) Jumlah Kerja 工作量	2 tires with BL1016 (16" Car Tires 215/60R16)

* All list price shown are for reference only (exclude SST).

* Semua harga yang ditunjukkan adalah untuk rujukan sahaja (tidak termasuk SST). 所有显示的建议零售价仅供参考 (不包括SST)。

12V_{max}

CXT

Li-ion Ah 4.0 | 2.0 | 1.5

Rechargeable Line Laser

Mesin Garis Laser Tanpa Kord 充电式激光水平仪



High brightness green laser for increased visibility at bright site

Laser hijau kecerahan tinggi 高亮度绿色激光

SK209GDZ | SK312GDZ GREEN
RM 7,065 | RM 8,338

Rechargeable Green Multi Line Laser
Mesin Garis Laser Tanpa Kord
充电式激光水平仪



- Horizontal line - 2-Vertical line - 2-Vertical line/ horizontal line (SK209GD)
- Horizontal line - Horizontal/ vertical line - 3-Vertical line/ horizontal line (SK312GD)

Standard Equipment: Laser Viewing Glass, Shoulder Strap, Storage Case

• DZ : Without Charger & Battery



SK106DZ RED | SK106GDZ GREEN
RM 2,015 | RM 3,408

Rechargeable Red 4-point Cross Line Laser
Mesin Garis Laser Tanpa Kord
充电式激光水平仪

- Brightness selection: 2 Modes (Bright mode/ Eco mode)

Standard Equipment: Soft Bag, Target Plate

• DZ : Without Charger & Battery



SK105DZ RED | SK105GDZ GREEN
RM 1,192 | RM 2,340

Rechargeable Red Cross Line Laser
Mesin Garis Laser Tanpa Kord
充电式激光水平仪

- Brightness selection: 2 Modes (Bright mode/ Eco mode)

Standard Equipment: Soft Bag, Target Plate

• DZ : Without Charger & Battery



Horizontal / 2-Vertical lines

SK209GD

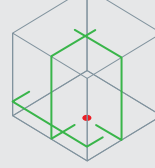

Horizontal / 3-Vertical lines

SK312GD

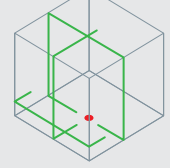

Cross line + Point

SK106D

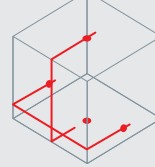

SK106GD

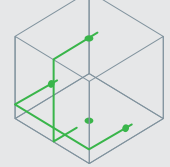

Cross line

SK105D



SK105GD

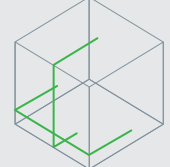

Leveling Accuracy Menunjukkan Ketepatan 指示精确度	±1mm/ 10m
Self-leveling Range Julat Indikasi Menegak 垂直指示范围	±2°
Laser Fan Angle Sudut Peminat Laser 激光扇角	Horizontal: 110°/ Vertical: 130°
Number of Laser Lines Bilangan Garisan Laser 激光线条数量	3
Laser Type Jenis Laser 激光类型	Laser class 2: 515nm
Tripod Thread Tripod 脚架	5/8"
Protection Class Tahap Perlindungan 保护等级	IP54
Dimensions (L x W x H) Dimensi 体积	BL1021B: 122x110x225mm
Net Weight Berat Bersih 净重	1.5 - 1.6kg (3.3 - 3.5lbs)
Continuous Usage Time (approx.) Masa Penggunaan Berterusan 连续使用时间	7.5 - 20 hrs with BL1021B SK209GD 5 - 14 hrs with BL1021B SK312GD

Measuring Range Jarak Mengukur 测量范围	Up to: 25m SK106D Up to: 35m SK106GD
Measuring Range w/ detector Jarak Mengukur 测量范围	Up to: 80m
Leveling Accuracy Menunjukkan Ketepatan 指示精确度	±3mm/ 10m
Self-leveling Range Julat Indikasi Menegak 垂直指示范围	±4°
Laser Fan Angle Sudut Peminat Laser 激光扇角	Horizontal: 180°/ Vertical: 170°
Number of Laser Bilangan Laser 激光数量	Points : 4 Lines : 2
Laser Type Jenis Laser 激光类型	Laser class 2: 635nm SK106D Laser class 2: 525nm SK106GD
Dimensions (L x W x H) Dimensi 体积	138x64x102mm (5-7/16"x2-1/2"x4")
Net Weight Berat Bersih 净重	0.69 - 0.85kg (1.5 - 1.9lbs.)
Continuous Usage Time (approx.) Masa Penggunaan Berterusan 连续使用时间	7.5 - 20 hrs with BL1021B SK106D 3.5 - 10 hrs with BL1021B SK106GD

Measuring Range Jarak Mengukur 测量范围	Up to: 25m SK105D Up to: 35m SK105GD
Measuring Range w/ detector Jarak Mengukur 测量范围	Up to: 80m
Leveling Accuracy Menunjukkan Ketepatan 指示精确度	±3mm/ 10m
Self-leveling Range Julat Indikasi Menegak 垂直指示范围	±4°
Laser Fan Angle Sudut Peminat Laser 激光扇角	Horizontal: 180°/ Vertical: 160°
Number of Laser Lines Bilangan Garisan Laser 激光线条数量	2
Laser Type Jenis Laser 激光类型	Laser class 2: 635nm SK105D Laser class 2: 525nm SK105GD
Dimensions (L x W x H) Dimensi 体积	138x64x102mm (5-7/16"x2-1/2"x4")
Net Weight Berat Bersih 净重	0.67 - 0.84 kg (1.5 - 1.9 lbs.)
Continuous Usage Time (approx.) Masa Penggunaan Berterusan 连续使用时间	7.5 - 20 hrs with BL1021B SK105D 3.5 - 10 hrs with BL1021B SK105GD

* All list price shown are for reference only (exclude SST).

* Semua harga yang ditunjukkan adalah untuk rujukan sahaja (tidak termasuk SST). 所有显示的建议零售价仅供参考 (不包括SST)。

Cordless
Tempat Kerja Tanpa Kabel

LED Flashlight
Lampu Senter LED
- LED LIGHT

Vacuum Cleaner
Penyedut Debu
- BLUET

Drilling / Fastening
Gergaji / Pengikat
- M12 / 18V

Impact Drilling / Demolition
Gergaji / Perseki
- 12.5MM, 18V/BLUET

Cutting
Pemotong
- 18V

Grinding / Smoothing
Gergaji / Perseki
- 18V

Sawing
Gergaji
- 18V

Planing / Routing
Pengiraan / Tugasan
- 18V / 20V

Others
Lain-lain
- 18V

Outdoor Power Equipment
Alatan Kuasa Luar
- 18V-20V

Makita
1921-11

10.8V

Li-ion Ah 1.3

Cordless Hammer Driver Drill

Tukul Pemutar Skru Bergerudi Tanpa Kord 充电式冲击螺丝起子电钻



DRILLING
Penggerudian 钻孔



FASTENING
Pengetat 紧固

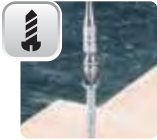

HAMMER DRILLING
Tukul Bergerudi 冲击电钻



HP330DWE 10mm (3/8")
RM 877

Cordless Hammer Driver Drill
Tukul Pemutar Skru Bergerudi Tanpa Kord
充电式冲击螺丝起子电钻



- Hammer drill mode

Standard Equipment: Phillips Bit, Holster

- DWE: 1x Standard Charger, 2x 1.3Ah Battery



Capacity Kapasiti 能力	Steel: 10mm (3/8") Wood: 21mm (13/16") Masonry: 8mm (5/16")
Impacts Per Minute (IPM) Impak Per Minit 冲击数	High: 0-22,500 Low: 0-6,000
No Load Speed (RPM) Kelajuan Tanpa Beban 回转数	High: 0-1,500 Low: 0-400
Max Fastening Torque Maksimum Tenaga Pemutaran Pengancing 最快扭力	Hard: 24N·m Soft: 12N·m
Max Lock Torque Pemutaran Tenaga Maksimum 最大扭力	22N·m (200in.lbs.)
Dimensions (L x W x H) Dimensi 体积	201x53x183mm (7-7/8"x2-1/16"x7-1/4")
Net Weight Berat Bersih 淨重	1.1kg (2.3lbs)
Work Amount (approx.) Jumlah Kerja 工作量	220 holes with BL1013 Auger Bit Drilling Ø9mm, Melapi 30mm Thickness

DF330DWE 10mm (3/8")
RM 687

Cordless Driver Drill
Gerudi Pemutar Skru Tanpa Kord
充电式螺丝起子电钻



- 2-Speed design driver drill

Standard Equipment: Phillips Bit, Holster

- DWE: 1x Standard Charger, 2x 1.3Ah Battery



Capacity Kapasiti 能力	Steel: 10mm (3/8") Wood: 21mm (13/16")
No Load Speed (RPM) Kelajuan Tanpa Beban 回转数	High: 0-1,300 Low: 0-350
Max Fastening Torque Maksimum Tenaga Pemutaran Pengancing 最快扭力	Hard: 24N·m Soft: 14N·m
Max Lock Torque Pemutaran Tenaga Maksimum 最大扭力	22N·m (200in.lbs.)
Dimensions (L x W x H) Dimensi 体积	189x53x183mm (7-7/16"x2-1/16"x7-1/4")
Net Weight Berat Bersih 淨重	1kg (2.2lbs)
Work Amount (approx.) Jumlah Kerja 工作量	220 holes with BL1013 Auger Bit Drilling Ø9mm, Melapi 30mm Thickness

DF030DWE 10mm (3/8")
RM 665

Cordless Driver Drill
Gerudi Pemutar Skru Tanpa Kord
充电式螺丝起子电钻



- 18 clutch settings and drill mode for added fastening control

Standard Equipment: Phillips Bit, Holster

- DWE: 1x Standard Charger, 2x 1.3Ah Battery



Capacity Kapasiti 能力	Steel: 10mm (3/8") Wood: 21mm (13/16")
No Load Speed (RPM) Kelajuan Tanpa Beban 回转数	High: 0-1,300 Low: 0-350
Max Fastening Torque Maksimum Tenaga Pemutaran Pengancing 最快扭力	Hard: 24N·m Soft: 14N·m
Max Lock Torque Pemutaran Tenaga Maksimum 最大扭力	22N·m (200 in.lbs.)
Dimensions (L x W x H) Dimensi 体积	157x53x183mm (6-3/16"x2-1/16"x7-1/4")
Net Weight Berat Bersih 淨重	0.89kg (2.0lbs)
Work Amount (approx.) Jumlah Kerja 工作量	190 holes with BL1013 Wood Drill ø9mm

TD090DWE
RM 755

Cordless Impact Driver
Pemutar Skru Impak Tanpa Kord
充电式冲击螺丝起子机



- Compact bit sleeve 1/4" drive

Standard Equipment: Holster

- DWE: 1x Standard Charger, 2x 1.3Ah Battery



Capacity Kapasiti 能力	Machine Screw: M4 - M8mm (5/32" - 5/16") Standard Bolt: M5 - M12 (3/16" - 1/2") High Tensile Bolt: M5 - M10 (3/16" - 3/8") Coarse thread (in length): 22 - 90mm (7/8" - 3-1/2")
No Load Speed (RPM) Kelajuan Tanpa Beban 回转数	0-2,400
Impacts Per Minute (IPM) Impak Per Minit 冲击数	0-3,000
Max Fastening Torque Maksimum Tenaga Pemutaran Pengancing 最快扭力	90N·m (800in.lbs.)
Dimensions (L x W x H) Dimensi 体积	155x54x178mm (6-1/8"x2-1/8"x7")
Net Weight Berat Bersih 淨重	0.92kg (2.0lbs)
Work Amount (approx.) Jumlah Kerja 工作量	550 pcs with BL1013 Bolts M8 x 16mm

* All list price shown are for reference only (exclude SST).

* Semua harga yang ditunjukkan adalah untuk rujukan sahaja (tidak termasuk SST). 所有显示的建议零售价仅供参考 (不包括SST)。

Cordless
Tukul Pemutar Skru Tanpa Kord

LED Flashlight
Lampu Cahaya LED
15000000

Vacuum Cleaner
Penyedut Vakuum
1500W

Drilling / Fastening
Gerudi / Pengetat
M4 - M8

Impact Drilling / Demolition
Gerudi / Demolisi
M4 - M8

Cutting
Pemotong
M4 - M8

Grinding / Sanding
Pengisar / Pasir
M4 - M8

Sawing
Gergaji
M4 - M8

Planing / Routing
Pengalir / Rutek
M4 - M8

Others
Lain-lain

Outdoor Power Equipment
Alat Kuasa Luar
M4 - M8





TD091DWE

RM 792

Cordless Impact Driver
Pemutar Skru Impak Tanpa Kord
充电式冲击螺丝起子机



- Battery power reduction warning lamp

• DWE: 1x Standard Charger, 2x 1.3Ah Battery



440 [mm]

Capacity Kapasiti 能力	Machine Screw: M4 - M8 (5/32" - 5/16") Standard Bolt: M5 - M12 (3/16" - 1/2") High Tensile Bolt: M5 - M10 (3/16" - 3/8") Coarse thread (in length): 22 - 90mm (7/8" - 3-1/2") 0 - 2,400
No Load Speed (RPM) Kelajuan Tanpa Beban 回转数	
Impacts Per Minute (IPM) Impak Per Minit 冲击数	0 - 3,000
Max Fastening Torque Maksimum Tenaga Pemutaran Pengancing 最快扭力	90N-m (800in.lbs.)
Dimensions (L x W x H) Dimensi 体积	134x54x200mm (5-1/4"x2-1/8"x7-7/8")
Net Weight Berat Bersih 净重	0.86kg (1.9lbs)
Work Amount (approx.) Jumlah Kerja 工作量	480 pcs with BL1013 Bolts M8x16mm

TW100DWE

RM 608

Cordless Impact Wrench
Perengkuh Impak Tanpa Kord
充电式冲击套筒扳手



- 9.5mm (3/8") square drive fits most common automotive sockets

• DWE: 1x Standard Charger, 2x 1.3Ah Battery



Fastening Capacities Kapasiti 能力	Standard Bolt: M8 - M12 (5/16" - 1/2") High Tensile Bolt: M6 - M10 (1/4" - 3/8") 9.5mm (3/8")
Square Drive Batang Segi Empat 四方头	
No Load Speed (RPM) Kelajuan Tanpa Beban 回转数	0 - 2,300
Impacts Per Minute (IPM) Impak Per Minit 冲击数	0 - 3,000
Max Fastening Torque Maksimum Tenaga Pemutaran Pengancing 最快扭力	110N-m (1,000in.lbs.)
Dimensions (L x W x H) Dimensi 体积	163x54x178mm (6-3/8"x2-1/8"x7")
Net Weight Berat Bersih 净重	0.95kg (2.1lbs)
Work Amount (approx.) Jumlah Kerja 工作量	550 pcs with BL1013 Bolts M8x16mm

CC300DW

RM 987

CC300DZ

RM 710

Cordless Cutter
Pemotong Tanpa Wayar
充电式切割机



- Adjustable cutting depth up to 25.5mm at 90° and 16.5mm at 45°

Standard Equipment: Diamond Wheel, Water Supply Tank Assembly, Hex Wrench

- DW: 1x Standard Charger, 1x 1.3Ah Battery
- DZ: Without Charger, Battery & Carrying Case



Blade Diameter Diameter Bilah 锯片直径	85mm (3-3/8")
Max Cutting Capacity Kapasiti Pemotongan Maksimum 最大切割能力	90°: 25.5mm (1") 45°: 16.5mm (5/8")
No Load Speed (RPM) Kelajuan Tanpa Beban 回转数	1,400
Tank capacity Kapasiti Tangki 水箱容量	Water : 0.5L
Dimensions (L x W x H) Dimensi 体积	300x170x154mm (11-3/4"x6-11/16"x6-1/16")
Net weight Berat Bersih 净重	16kg (3.6lbs)
Work Amount (approx.) Jumlah Kerja 工作量	2.5 pcs with BL1013 Diamond Blade (Cut Glass 10x300mm)

HS300DW

RM 832

Cordless Circular Saw
Gergaji Piring Tanpa Kord
充电式圆锯



- Fast cutting of plywood, MDF, pegboard, particleboard, melamine, drywall and more

Standard Equipment: TCT Saw Blade (B-14607), Hex Wrench

- DW: 1x Standard Charger, 1x 1.3Ah Battery



Blade Diameter Diameter Bilah 锯片直径	85mm (3-3/8")
Max Cutting Capacity Kapasiti Pemotongan Maksimum 最大切割能力	90°: 25.5mm (1") 45°: 16.5mm (5/8")
No Load Speed (RPM) Kelajuan Tanpa Beban 回转数	1,400
Dimensions (L x W x H) Dimensi 体积	300x170x154mm (11-3/4"x6-11/16"x6-1/16")
Net Weight Berat Bersih 净重	1.5kg (3.4lbs)
Work Amount (approx.) Jumlah Kerja 工作量	90 cuts with BL1013 Sawing SPF 1"x4" (0 Degree Cut)

JV100DWE

RM 865

Cordless Jig Saw
Gergaji Jig Tanpa Kord
充电式线锯机



- Aluminum die-cast base adjusts from 0°-45° right to left

Standard Equipment: Jig Saw Blade (B-10), Hex Wrench, Guide Rule

- DWE: 1x Standard Charger, 2x 1.3Ah Battery



Max Cutting Capacity at 90° Kapasiti Pemotongan Maksimum 最大切割能力	Wood: 65mm (2-9/16") Aluminum: 4mm (5/32") Mild Steel: 2mm (1/16")
Length of Stroke Panjang Strok 冲程长度	18mm (11/16")
Strokes Per Minute (SPM) Kelajuan Strok 冲程速度	0 - 2,400
Dimensions (L x W x H) Dimensi 体积	231x76x196mm (9-1/8"x3"x7-3/4")
Net Weight Berat Bersih 净重	1.7kg (3.7lbs)
Work Amount (approx.) Jumlah Kerja 工作量	26 pcs with BL1013 Sawing (Fibreboard MDF 300x12mm)

* All list price shown are for reference only (exclude SST).

* Semua harga yang ditunjukkan adalah untuk rujukan sahaja (tidak termasuk SST). 所有显示的建议零售价仅供参考 (不包括SST)。

Cordless
Tempat Kerja
Tempat Kerja

LED Flashlight
Lampu Senter LED
LED LIGHT

Vacuum Cleaner
Penyedut Debu
VACUUM

Drilling / Fastening
Gergaji / Pengikat
MIL / 螺絲

Impact Drilling / Demolition
Gergaji / Pecah
IMPACT / 破壁機

Cutting
Pemotong
CUT

Grinding / Sanding
Gergaji / Hiris
GRIND / 磨

Sawing
Gergaji
SAW

Planing / Routing
Pajuan / Tugam
PLAN / 刨

Others
Lain-lain
OTHER

Outdoor Power Equipment
Alatan Kuat Tahan Luar
OUTDOOR POWER EQUIPMENT



3.6V

14.4V

DF001DW **Li-ion** 3.6V In-Line Cordless Screwdriver

Pemutar Skru Tanpa Kord Yang Tahan Lasak 充电式螺丝起子机

Comes with 81pcs assortment and Charger

Termasuk 81 bit dan pengecas | 81支配件与充电器套装

Drive type

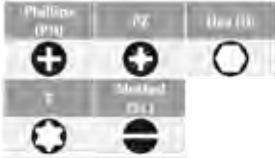

C-form 25mm Screw bit

- PZ : 0, 1, 2, 3 (3pc each)
- Hex : 2, 2.5, 3, 4, 5, 6 (2pc each)
- T : 10, 15, 20, 25, 27, 30, 40 (3pc each)
- SL : 0.5x3, 0.5x4, 0.6x4.5, 0.8x5.5, 1.0x5.5, 1.2x6.5 (2pc each)
- PH : 0, 1, 2 (3pc each), 3 (2pc each)

E-form 50mm Screw bit

- T : 20, 25, 30 (1pc each)
- PH : 1, 2, 3 (1pc each)

E-form Socket Wrench

- 5, 6, 7, 8, 9, 10mm (1pc each)

E-form magnetic bit holder

- 60mm (1pc each)



Straight style
Dalam keadaan
melurus 直式

**Can be used as both of straight
style and pistol
style**
Boleh digunakan dalam keadaan melurus
atau pistol/ 可以用作直式和手枪式两种方式

Pistol style
Dalam keadaan
pistol 手枪式

DF001DW RM 353

In-Line Cordless Screwdriver

Pemutar Skru Tanpa Kord
充电式螺丝起子机



3.6V



- Convenient to used even in narrow space

Standard Equipment: Bit Set 81pcs, AC Adaptor, USB Cable



Fastening Capacities

Kapasiti Pengancing 最大紧固能力

No Load Speed (RPM)

Kelajuan Tanpa Beban 无负荷转速

Max Fastening Torque

Maksimum Tenaga Pemutaran Pengancing 最快扭转

Max Lock Torque

Maksimum Pengunci Tenaga Pemutaran 最大扭转

Charging Time (hours)

Masa Pengecasan 充电时间

Dimensions (L x W x H)

Dimensi 体积

Net Weight

Keberatan 净重

Work Amount (approx.)

Jumlah Kerja 工作量

Wood Screw: $\phi 3.8 \times 32\text{mm}$

(1/8"x1-1/4")

220

Hard: 4.0N·m (35in.lbs.)

Soft: 3.0N·m (27in.lbs.)

6.0N·m (53 in.lbs.)

3 - 5

Straight Style: 287x47x51mm

(11-1/4"x1-7/8"x2")

Pistol Style: 205x47x51mm

(8-1/8"x1-7/8"x2")

0.36kg (0.8 lbs.)

200 pcs

Wood Screw $\phi 3.8 \times 25\text{mm}$ (SPF plate)

DTL062Z 9.5mm (3/8") RM 1,218

Cordless Angle Impact Wrench

Perengkuh Impak Sudut
Tanpa Kord
充电式角向冲击套筒扳手



14.4V



- Compact angle head for easy access to bolts
in tight places

Standard Equipment: Belt Clip

- Z: Without Charger & Battery



Fastening Capacities

Kapasiti 能力

Square Drive

Skrus Persegi 方形螺栓

No Load Speed (RPM)

Kelajuan Tanpa Beban 回转数

Impacts Per Minute (IPM)

Impak Per Minit 冲击数

Max Fastening Torque

Pemutaran Tenaga Maksimum 最大扭力

Dimensions (L x W x H)

Dimensi 体积

Net Weight

Berat Bersih 净重

Standard Bolt:

M4 - M12 (5/32" - 1/2")

High Strength Bolt:

M4 - M8 (5/32" - 5/16")

9.5mm (3/8")

0 - 2,000

0 - 3,000

60N·m

387x78x97mm

(15-1/4"x3-1/16"x3-13/16")

1.4 - 1.8kg (3.0 - 4.1lbs.)

DTW152Z 12.7mm (1/2") RM 1,205

Cordless Impact Wrench

Perengkuh Impak Tanpa Kord
充电式冲击套筒扳手



14.4V



- Compact and lightweight 4-pole motor

Standard Equipment: Belt Clip

- Z: Without Charger & Battery



Fastening Capacities

Kapasiti 能力

Square Drive

Skrus Persegi 方形螺栓

No Load Speed (RPM)

Kelajuan Tanpa Beban 回转数

Impacts Per Minute (IPM)

Impak Per Minit 冲击数

Max Fastening Torque

Pemutaran Tenaga Maksimum 最大扭力

Dimensions (L x W x H)

Dimensi 体积

Net Weight

Berat Bersih 净重

Standard Bolt:

M8 - M16 (5/16" - 5/8")

High Strength Bolt:

M8 - M12 (5/16" - 1/2")

12.7 mm (1/2")

0 - 2,400

0 - 3,200

200N·m (150ft.lbs.)

158x79x234mm

(6-1/4"x3-1/8"x9-1/4")

1.3 - 1.5kg (2.8 - 3.4lbs.)

* All list price shown are for reference only (exclude SST).

* Semua harga yang ditunjukkan adalah untuk rujukan sahaja (tidak termasuk SST). 所有显示的建议零售价仅供参考 (不包括SST)。

Cordless
Tempa Kord

LED Flashlight
Lampu Sinar LED
LED LIGHT

Vacuum Cleaner
Penyedut Vakuam
VACUUM

Drilling / Fastening
Galian / Pengikat
DRILL / FASTEN

Impact Drilling / Demolition
Galian / Pecahan
IMPACT DRILL

Cutting
Pengiraian
CUTTING

Grinding / Sanding
Pengiraian / Pasut
GRINDING / SANDING

Sawing
Gajut
SAWING

Planing / Routing
Pajutan / Tugaman
PLANING / ROUTING

Others
Lain-lain
OTHERS

Outdoor Power Equipment
Alatan Kuat Daya Luar
OUTDOOR POWER EQUIPMENT

Makita
MAKITA

18V

12V

9.6V

DF488DWE 13mm (1/2")

RM 765

Cordless Driver Drill
Gerudi Pemutar Skru Tanpa Kord
充电式螺丝起子电钻



18V
G-Battery



- 16 clutch settings and drill mode for added fastening control

Standard Equipment: (+)(-) Bit

- DWE: 1x Standard Charger, 2x 1.5Ah G-Battery



DF488D/HP488D
Models and specs may vary by country

Capacity Kapasiti 能力	Steel: 13mm (1/2") Wood: 36mm (1-7/16")
Chuck Capacity Kapasiti Chuck 夹头能力	1.5 - 13mm (1/16 - 1/2")
No Load Speed (RPM) Kelajuan Tanpa Beban 回转速	High: 0 - 1,400 Low: 0 - 400
Max Fastening Torque Maksimum Tenaga Pemutaran Pengancing 最快扭力	Hard: 42N-m (370 in.lbs) Soft: 24N-m (210 in.lbs)
Max Lock Torque Pemutaran Tenaga Maksimum 最大扭力	38N-m (340in.lbs.)
Clutch Torque Setting Tetapan Pemutaran 扭转设置	1 - 4N-m (9 - 35in.lbs.)
Dimensions (L x W x H) Dimensi 体积	221x83x240mm (8-3/4x3-1/4x9-1/2")
Net Weight Berat Bersih 淨重	1.7kg (3.7lbs.)

HP488DWE 13mm (1/2")

RM 855

Cordless Hammer Driver Drill
Tukul Pemutar Skru Bergerudi Tanpa Kord
充电式冲击螺丝起子电钻



18V
G-Battery



- 16 clutch settings and drill mode for added fastening control

Standard Equipment: (+)(-) Bit

- DWE: 1x Standard Charger, 2x 1.5Ah G-Battery



DF488D/HP488D
Models and specs may vary by country

Capacity Kapasiti 能力	Steel: 13mm (1/2") Wood: 36mm (1-7/16") Masonry: 13mm (1/2")
Chuck Capacity Kapasiti Chuck 夹头能力	1.5 - 13mm (1/16 - 1/2")
Impacts Per Minute (IPM) Impak Per Minit 冲击数	High: 0 - 21,000 Low: 0 - 6,000
No Load Speed (RPM) Kelajuan Tanpa Beban 回转速	High: 0 - 1,400 Low: 0 - 400
Max Fastening Torque Maksimum Tenaga Pemutaran Pengancing 最快扭力	Hard: 42N-m (370 in.lbs) Soft: 24N-m (210 in.lbs)
Max Lock Torque Pemutaran Tenaga Maksimum 最大扭力	38N-m (340in.lbs.)
Clutch Torque Setting Tetapan Pemutaran 扭转设置	1 - 4N-m (9 - 35in.lbs.)
Dimensions (L x W x H) Dimensi 体积	239x83x240mm (9-3/8x3-1/4x9-1/2")
Net Weight Berat Bersih 淨重	1.8kg (4.0lbs.)

UM110DWYX 110mm (4-5/16")

RM 757

Cordless Grass Shear
Pemotong Rumput Tanpa Kord
充电式割草机



18V
G-Battery



- 2 in 1: Both trimmer blade and shear blade can be attached

Standard Equipment: Shear Blade, Blade Cover, Storage Cover, Oil Vessel

- DWYX: 1x Standard Charger, 1x 1.5Ah G-Battery



Cutting Width Lebar Keratan 切割宽度	Grass Shear Blade: 110mm (4-5/16") Hedge Trimmer Blade: 200mm (7-7/8")
Depth Adjustment Pelarasan Kedalaman 深度调整	15mm (9/16") 20mm (13/16") 25mm (1")
Strokes Per Minute (SPM) Kelajuan Strok 冲程速度	2,500
Dimensions (L x W x H) Dimensi 体积	331x120x130mm (13x4-3/4x5-1/8")
Net Weight Berat Bersih 淨重	1.4 - 1.5kg (3.1 - 3.3lbs.)
Continuous Usage Time (approx.) Masa Penggunaan Berterusan 连续使用时间	65min with BL1815G

6271DWE 10mm (3/8")

RM 745

Cordless Driver Drill
Gerudi Pemutar Skru Tanpa Kord
充电式螺丝起子电钻



12V
Ni-Cd Battery



- All metal gear construction ensures high transmission durability

Standard Equipment: (+)(-) Bit

- DWE: 1x Standard Charger, 2x 1.3Ah Ni-Cd Battery



Capacity Kapasiti 能力	Steel: 10mm (3/8") Wood: 21mm (13/16")
No Load Speed (RPM) Kelajuan Tanpa Beban 回转速	High: 0-1,300 Low: 0-400
Max Fastening Torque Maksimum Tenaga Pemutaran Pengancing 最快扭力	Hard: 30N-m / Soft: 18N-m
Dimensions (L x W x H) Dimensi 体积	192x95x240mm (7-9/16"x3-3/4"x9-1/2")
Net Weight Berat Bersih 淨重	1.5kg (3.4lbs.)

4190DW 80mm (3-1/8")

RM 1,765

Cordless Cutter
Pemotong Tanpa Wayar
充电式切割机



9.6V
Ni-Cd Battery



- Fast and easy glass and ceramic tile cutting

Standard Equipment: Diamond Wheel (792296-4), Hex Wrench

- DW: 1x Standard Charger, 1x 1.3Ah Ni-Cd Battery

Blade Diameter Diameter Bilah 锯片直径	80mm (3-1/8")
Max Cutting Capacity Kapasiti Pemotongan Maksimum 最大切割能力	90°: 18mm (11/16") 45°: 16mm (5/8")
No Load Speed (RPM) Kelajuan Tanpa Beban 回转速	1,000
Overall Length Dimensi 体积	313mm (12-3/8")
Net Weight Berat Bersih 淨重	1.9kg (4.2lbs.)

* All list price shown are for reference only (exclude SST).

* Semua harga yang ditunjukkan adalah untuk rujukan sahaja (tidak termasuk SST). 所有显示的建议零售价仅供参考 (不包括SST)。

Cordless
Tanjap-Kuching

LED Flashlight
Lampu Cahaya LED
15000000

Vacuum Cleaner
Penyedut Vakuum
MUSK

Drilling / Fastening
Druv / Pengapit
M10 / 1.3mm

Impact Drilling / Demolition
Druv / Demolisi
5.2mm / 1.3mm

Cutting
Pemotongan
1.3mm

Grinding / Sanding
Pengisar / Pasir
2mm / 1.3mm

Sawing
Druv
1.3mm

Planing / Routing
Pengisar / Rutek
M10 / 1.3mm

Others
Lain-lain
1.3mm

Outdoor Power Equipment
Alat Kuasa Luar
M10-1.3mm

Makita
1911

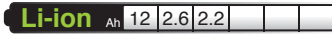

BUH550RD | **BUH550Z** | **UH550DWB** 550mm (21-5/8") 442 (RM)

Cordless Hedge Trimmer
Pemangkas Tanaman Pagar Tanpa Kord
充电式篱笆树剪



- 5-Position rotating rear handle for increased comfort during vertical and angle trimming

Standard Equipment: Blade Cover

- RD: 1x 36V Rapid Charger (DC36RA), 1x 36V 2.6Ah Battery (BL3626)
- DWB: 1x 36V Standard Charger (DC36WA), 1x 36V 2.2Ah Battery (BL3622A)
- Z: Without Charger & Battery



Blade Length Panjang bilah 刀片长度	550mm (21-5/8")
Strokes Per Minute (SPM) Kelajuan Strok 冲程速度	2,000 - 3,600
Tooth Spacing Selang Gigi 牙齿间隔	36mm (1-7/16")
Dimensions (L x W x H) Dimensi 体积	1,070x220x190mm (42"x8-5/8"x7-1/2")
Net Weight Keberatan 净重	5.1kg (11.2lbs.)

BUH650RD | **BUH650Z** | **UH650DWB** 650mm (25-1/2") 442 (RM)

Cordless Hedge Trimmer
Pemangkas Tanaman Pagar Tanpa Kord
充电式篱笆树剪



- 5-Position rotating rear handle for increased comfort during vertical and angle trimming

Standard Equipment: Blade Cover

- RD: 1x 36V Rapid Charger (DC36RA), 1x 36V 2.6Ah Battery (BL3626)
- DWB: 1x 36V Standard Charger (DC36WA), 1x 36V 2.2Ah Battery (BL3622A)
- Z: Without Charger & Battery



Blade Length Panjang bilah 刀片长度	650mm (25-1/2")
Strokes Per Minute (SPM) Kelajuan Strok 冲程速度	2,000 - 3,600
Tooth Spacing Selang Gigi 牙齿间隔	36mm (1-7/16")
Dimensions (L x W x H) Dimensi 体积	1,150x220x190mm (45-1/4"x8-5/8"x7-1/2")
Net Weight Keberatan 净重	5.2kg (11.5lbs.)

BUN490RD RM 5,998

Cordless Pole Hedge Trimmer
Pemangkas Tanaman Pagar Tinggi Tanpa Kord
充电式高枝篱笆树剪

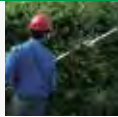

- Can be folded in the 180° position for easy transport and storage

Standard Equipment: Band Assembly, Wrench, Accessory Bag

- RD: 1x 36V Rapid Charger (DC36RA), 1x 36V 2.6Ah Battery (BL3626)



Strokes Per Minute (SPM) Kelajuan Strok 冲程速度	High: 0 - 4,000 Low: 0 - 2,800
Tooth Spacing Selang Gigi 牙齿间隔	35mm (1-3/8")
Dimensions (L x W x H) Dimensi 体积	2,595x226x211mm (100-3/16"x8-7/8"x8-5/16")
Net Weight Keberatan 净重	6.9kg (15.2 - 15.3lbs.)

BBC231UZ | **BC231UDWBE** RM 3,542 | RM 8,553

Cordless Brushcutter
Pemotong Rumput Tanpa Kord
充电式割草机



- Low noise level and zero emissions for operator comfort

Standard Equipment: Blade, Guard, Shoulder Harness with Double Shoulder Strap, Wrenches

- UWBE: 1x 36V Standard Charger (DC36WA), 2x 36V 2.2Ah Battery (BL3622A)
- UZ: Without Charger & Battery



No Load Speed (RPM) Kelajuan Tanpa Beban 回转数	High: 0-7,300 Low: 0-5,300
Spindle Size Saiz Spindel 主轴尺寸	M10 x 1.25LH
Dimensions (L x W x H) Dimensi 体积	1,880x620x490mm (74"x24-3/8"x19-1/4")
Net Weight Keberatan 净重	7.1kg (15.7lbs.)
Continuous Usage Time (approx.) Masa Penggunaan Berterusan 连续使用时间	Low: 30 min with BL3626 Metal blade with load

BML360Z (STEXBML360) RM 399.10

Cordless Fluorescent Light
Lampu Suluh Tanpa Kord
充电式工作灯

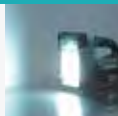

- Wide and bright illumination

- Z: Without Charger & Battery



Dimensions (L x W x H) Dimensi 体积	283x128x203mm (11-1/8"x5"x8")
Net Weight Berat Bersih 净重	2.3kg (5.1lbs.)

* All list price shown are for reference only (exclude SST).

* Semua harga yang ditunjukkan adalah untuk rujukan sahaja (tidak termasuk SST). 所有显示的建议零售价仅供参考 (不包括SST)。

Cordless
Tempat Kerja Bebas

LED Flashlight
Lampu Suluh LED
- LED BRIGHT

Vacuum Cleaner
Penyedut Debu
- 2.5L

Drilling / Fastening
Gergasi / Pengikat
- 1/2" | 3/8"

Impact Drilling / Demolition
Gergasi / Pecah
- 1/2" | 3/8"

Cutting
Memotong
- 1/2"

Grinding / Smoothing
Mencik / Muluskan
- 1/2"

Sawing
Gergasi
- 1/2"

Planing / Routing
Mencari / Mengukir
- 1/2" | 3/8"

Others
Lain-lain
- 1/2"

Outdoor Power Equipment
Alatan Kuasa Luar
- 1/2"





Cordless Coffee Maker

Mesin Kopi Tanpa Kord 充电式咖啡机



Cordless
Tanpa Kord Tanpa Kord

LED Flashlight
Lampu Cahaya LED
LED BATERAI

Vacuum Cleaner
Penyedot Debu
BUCK

Drilling / Fastening
Drovo / Pasak
M18 / 18V

Impact Drilling / Demolition
Drovo / Demolisi
5.2 Ah / 5.2 Ah

Cutting
Pemotongan
18V

Grinding / Sanding
Finis / Pasak
18V / 18V

Sawing
Gergaji
18V

Planing / Routing
Planing / Ratakan
M18 / 18V

Others
Lain-lain
18V

Outdoor Power Equipment
Mesin Tenaga Luar
M18 / 18V

Makita
18V

Job Site Radio

Radio Tanpa Kord 充电式收音机



Cordless Fan

Kipas Tanpa Kord 充电式风扇



18V

LXT

Li-ion Ah 6.0 | 5.0 | 4.0 | 3.0 | 2.0 | 1.5

7 Selectable Sound Modes

7 Mod bunyi yang boleh dipilih 7种可选声音模式

Equalizer	LED		
FLAT	White	CLASSIC	Brown
		POP	Pink
JAZZ	Blue	NEWS	Yellow
ROCK	Red	MY EQ	Green



Carry handle with built in FM antenna

Carry handle dengan terbita dalam antenna FM
内置手柄调频天线



USB output port allows for charging a mobile device

• Type A USB socket for DC5V / 2.4A USB output



AUX-IN jack

Jack AUX-IN AUX-IN插孔



DMR114 18V / 12Vmax / AC
RM 1,805

Job Site Radio
Radio Tanpa Kord
充电式收音机



• Equipped with equalizer for 7 selectable sound modes

Standard Equipment: AC Adaptor

• Without Charger & Battery



Frequency Band Julat Kekerapan 频率范围	FM: 87.5 - 108MHz AM: 522 - 1,710kHz
Speaker Size Saiz Speaker 喇叭尺寸	Sides: Ø63.5mm x2 Bottom: Ø101.6mm
Bluetooth Bluetooth 蓝牙连接	Version: 5.0 Profile: A2DP SCMS-T AVRCP Supported Codec: SBC / AAC Max Transmission Range: (Optimum): 10m (33ft) (Possible): 30m (98ft) Transmission Power Class: 2 Compatible Bluetooth Profile: A2DP

Dimensions (L x W x H) Dimensi 体积	268x164x295mm (10-1/2"x6-1/2"x11-5/8")
Net Weight Berat Bersih 净重	4.9 - 5.6kg (10.8 - 12.3lbs.)
Continuous Usage Time (approx.) Masa Penggunaan Berterusan 连续使用时间	17 hrs with BL1850B

DMR203 18V / 12Vmax / AC
RM 1,222

Cordless Job Site Speaker
Pembesar Suara Tanpa Kord
充电式音箱



• Equipped with equalizer for 7 selectable sound modes

Standard Equipment: AC Adaptor

• Without Charger & Battery



Speaker Size Saiz Speaker 喇叭尺寸	Woofer: Ø101.6mm Tweeter: Ø36mm Passive Radiator: Ø89mm
--	---

Bluetooth Bluetooth 蓝牙连接	Version: 5.0 Profile: A2DP SCMS-T AVRCP Supported Codec: SBC Max Transmission Range: 10m (33ft) Max Transmission Range (Possible): 30m (100ft)
------------------------------------	--

Dimensions (L x W x H) Dimensi 体积	217x206x199mm (8-1/2"x8-1/8"x7-7/8")
Net Weight Berat Bersih 净重	2.7 - 3.4kg (6.0 - 7.5lbs.)
Continuous Usage Time (approx.) Masa Penggunaan Berterusan 连续使用时间	29 hrs with BL1850B (AUX-IN)

Product Comparison List

Senarai Perbandingan Produk 产品对比表

	18V	12V max
Run time (hrs)	Up to: 17 with BL1850B	Up to: 26 Bluetooth: with BL1850B
Bluetooth	●	●
Net weight	5.1 - 5.6kg (11.3 - 12.3lbs.)	2.7 - 3.4kg (6.0 - 7.5lbs.)

* All list price shown are for reference only (exclude SST).

* Semua harga yang ditunjukkan adalah untuk rujukan sahaja (tidak termasuk SST). 所有显示的建议零售价仅供参考 (不包括SST)。

Cordless
Tempat Kerja Tanpa Kord

LED Flashlight
Lampu Sorot LED
LED BERTENAGA

Vacuum Cleaner
Penyedut Debu
BLUET

Drilling / Fastening
Galian / Pasang
MIL / BERTENAGA

Impact Drilling / Demolition
Galian / Pasang
MIL / BERTENAGA

Cutting
Memotong
MIL

Grinding / Smoothing
Mencikil / Mengkilap
MIL / BERTENAGA

Sawing
Gergaji
MIL

Planing / Routing
Mencikil / Mengkilap
MIL / BERTENAGA

Others
Lain-lain
MIL

Outdoor Power Equipment
Alatan Kuasa Luar
MIL / BERTENAGA

Makita
MIL

18V

LXT

12V_{max}

CXT

Li-ion Ah 6.0 5.0 4.0 3.0 2.0 1.5

Cordless Fan

Kipas Tanpa Kord 充电式风扇



Adjustable fan head angle
Sudut kepala kipas boleh laras 可调整风扇头角度



Automatic swing fan
Left/ Right 45°
Kipas pusing automatik Kiri / Kanan 45°
自动摇摆左/右45°



Max Air Speed
Kelajuan angin maksimum
最大风速
190m/min

*Masa Penggunaan Berterusan
连续使用时间
Continuous Usage Time
with BL1850B x1
(High Speed)
360min
(approx.)

* Continuous Usage Time/ Work Amount:
Actual performance may vary based on application.
Masa Penggunaan Berterusan/ Jumlah Kerja: Prestasi sebenar
mungkin berbeza mengikut aplikasi.
连续使用时间/工作量: 实际表现可能因应用而异。

DCF203Z 18V / 14.4V
RM 1,290

Cordless Fan
Kipas Tanpa Kord
充电式风扇



• Cordless automatic swing fan



VIDEO CLIP
Models and specs
may vary by country.

• Z : Without Charger & Battery



Max Air Velocity Kelajuan Angin Maksimum 最大风速	High: 190m/min Med: 150m/min Low: 120m/min
Air Flow Aliran Udara 空气流量	High: 8.2m ³ /min Med: 6.5m ³ /min Low: 5.2m ³ /min
Dimensions (L x W x H) Dimensi 体积	140x333x447mm (5-1/2"x13"x16-1/2")
Net Weight Berat Bersih 净重	1.9 - 2.6kg (4.2 - 5.6lbs.)
Continuous Usage Time (approx.) Masa Penggunaan Berterusan 连续使用时间	Low: 1,010 min Med: 650 min High: 410 min with BL1860B

DCF102Z 18V / 14.4V
RM 678

Cordless Fan
Kipas Tanpa Kord
充电式风扇



• Automatically Swings 45° L/R

• Z : Without Charger & Battery



Air Flow Aliran Udara 空气流量	High: 4.6L/min Med: 3.8L/min Low: 3.0L/min
Dimensions (L x W x H) Dimensi 体积	185x272x284mm (7-1/4"x10-3/10"x11-1/8")
Net Weight Berat Bersih 净重	1.3 - 2.0kg (2.9 - 4.4lbs.)
Continuous Usage Time (approx.) Masa Penggunaan Berterusan 连续使用时间	Low: 1,270 min Mid: 705 min High: 575 min with BL1860B

DCF201Z 18V
RM 545

Cordless Fan
Kipas Tanpa Kord
充电式风扇



• Strong enough to create a comfortable work environment under hot weather

• Z : Without Charger & Battery



Dimensions (L x W x H) Dimensi 体积	263x330x523mm (10-3/8"x13"x20-5/8")
Net Weight Berat Bersih 净重	2.5 - 2.9kg (5.5 - 6.3lbs.)
Continuous Usage Time (approx.) Masa Penggunaan Berterusan 连续使用时间	Low: 330min High: 165min with BL1850B

* All list price shown are for reference only (exclude SST).

* Semua harga yang ditunjukkan adalah untuk rujukan sahaja (tidak termasuk SST). 所有显示的建议零售价仅供参考 (不包括SST)。

Cordless Impact Driver
LED Flashlight
Vacuum Cleaner
Drilling / Fastening
Impact Drilling / Demolition
Cutting
Grinding / Sanding
Sawing
Planing / Routing
Oilers
Outdoor Power Equipment





CF101DZ 12Vmax
RM 643

Cordless Fan
Kipas Tanpa Kord
充电式风扇



- Automatically Swings 45° L/R

• Z: Without Charger & Battery



Air Flow Aliran Udara 空气流量	High: 4.6L/min Med: 3.8L/min Low: 3.0L/min
Dimensions (L x W x H) Dimensi 体积	185x260x284mm (7-1/4"x10-1/4"x11-1/8")
Net Weight Berat Bersih 净重	1.3 - 1.7kg (2.8 - 3.8lbs.)
Continuous Usage Time (approx.) Masa Penggunaan Berterusan 连续使用时间	Low - 315min Med - 190min High - 135min with BL1021B

CF100DZ 12Vmax / AC
RM 487

Cordless Fan
Kipas Tanpa Kord
充电式风扇



- Compact Size Allows Installation Even in Small Spaces

Standard Equipment: AC Adaptor

• Z: Without Charger & Battery



Dimensions (L x W x H) Dimensi 体积	148x260x252mm (5-7/8x10-1/4x9-7/8")
Net Weight Berat Bersih 净重	1.2 - 1.4kg (2.7 - 3.1lbs)
Continuous Usage Time (approx.) Masa Penggunaan Berterusan 连续使用时间	Low - 315min Med - 190min High - 135min with BL1021B

Product Comparison List 18V 12Vmax

Senarai Perbandingan Produk 产品对比表

	DCF203	DCF102	DCF201	CF101D	CF100D
Run time (min.)	High: 360 Med: 580 Low: 960 with BL1850B	High: 480 Med: 585 Low: 1060 with BL1850B	High: 180 Low: 400 with BL1850B	High: 275 Med: 380 Low: 630 with BL1041B	High: 275 Med: 380 Low: 630 with BL1041B
Max air speed (m/min)	190	180	120	180	180
Fan size (mm)	235	180	230	180	180
Automatic swing fan	●	●	●	●	●
Net weight	1.9 - 2.6 kg (4.2 - 5.6 lbs.)	1.3 - 2.0 kg (2.9 - 4.4 lbs.)	2.2 - 2.7 kg (4.9 - 5.9 lbs.)	1.3 - 1.7 kg (2.8 - 3.8 lbs.)	1.2 - 1.4 kg (2.7 - 3.1 lbs.)

ADP05 (AUBADP05) 18V
RM 161

Adapter for USB
Penyesuai untuk USB
USB适配器



- As a charger for smart phones

• Without Charger & Battery

USB Port Soket USB USB接口位置	2 (A type)
Dimensions (L x W x H) Dimensi 体积	102x72x43mm (4"x2-13/16"x1-11/16")
Net Weight Berat Bersih 净重	0.46 - 0.71kg (1.0 - 1.6lbs)
Work Amount (approx.) Jumlah Kerja 工作量	10times with BL1850B Charging Iphone 6S (1715 mA-h)

* All list price shown are for reference only (exclude SST).
* Semua harga yang ditunjukkan adalah untuk rujukan sahaja (tidak termasuk SST). 所有显示的建议零售价仅供参考 (不包括SST)。



18V

LXT

12Vmax

CXT

Li-ion Ah 6.0 5.0 4.0 3.0 2.0 1.5

ADP06 (AUAADP06)
RM 162.20

ADP08 (AUAADP08) 12Vmax
RM 135.90

Adapter for USB
Penyesuai untuk USB
USB适配器



ADP06



ADP08



• As a charger for smart phones

• Without Charger & Battery

Battery Bateri 电池	12Vmax 1.5Ah, 2.0Ah, 4.0Ah
USB Port Soket USB USB插口位置	1 (type A)
Devices Peralatan 设备	iOS & Android
Dimensions (L x W x H) Dimensi 体积	80x53x38mm ADP06 (3-1/8"x2-1/16"x1-1/2") 80x53x28mm ADP08 (3-1/8"x2-1/16"x1-1/8")
Net Weight Berat Bersih 淨重	0.27 - 0.44kg (0.6 - 1.0lbs)
Work Amount Jumlah Kerja 工作量	1 time charges with BL1021B ADP06 Charging Iphone 7 (1960 mA-h) 1 time charges with BL1021B ADP08 Charging Iphone 7 (1960 mA-h)

Cordless Coffee Maker

Mesin Kopi Tanpa Kord 充电式咖啡机

18V LITHIUM-ION
18V 锂离子电池

12Vmax LITHIUM-ION
12V 锂离子电池

Capacity of Cup



Makita Cafe pod 120mL
Ground coffee (6.5g) 160mL

Carry Handle
for easy transport
Pemegang mudah dibawa
手柄便于携带

Water Tank Capacity
Kapasiti Tangki Air
水箱容量

240mL

Dedicated Cup Capacity
240mL



Makita genuine cafe pods are prepared 20pcs/box



Brazil
Fragrant bitter & deep flavor



Mocha
Sweet scent & mild taste



Kilimanjaro
Aftertaste with bitter sweet & sharpness

Cover is slide left and right to protect the empty port when a battery is inserted

Tutup adalah gelongsor kiri dan kanan untuk melindungi port kosong apabila bateri dimasukkan
左右滑动保护盖，以在插入电池时保护空的端口

DCM501Z 18V / 12Vmax
RM 830

Cordless Coffee Maker
Mesin Kopi Tanpa Kord
充电式咖啡机



• Large tank capacity of 240 mL

Water Tank Capacity Dimensi 体积	240mL
Compatible Cafe Pod Type Berat Bersih 淨重	60mm
Dimensions (L x W x H) Masa Penggunaan Berterusan 连续使用时间	243x187x218mm (9-9/16"x7-3/8"x8-9/16")
Net Weight	1.9 - 2.2kg (4.1 - 4.8lbs.)
Continuous Usage Time (approx.)	4cups 160mL Coffee with BL1860B

Standard Equipment: Mug, Measuring Spoon

• Z : Without Charger & Battery



DCM501

VIDEO CLIP
Models and specs may vary by country

* All list price shown are for reference only (exclude SST).

* Semua harga yang ditunjukkan adalah untuk rujukan sahaja (tidak termasuk SST). 所有显示的建议零售价仅供参考 (不包括SST)。



Li-ion Ah 6.0 5.0 4.0 3.0 2.0 1.5

Cordless Fan Jacket

Jaket Kipas Tanpa Kord 充电式风扇外套



Max Air Flow
Aliran Udara Maksimum
最大空气流量
2.2 m³/min
(Turbo Mode)

Model No.	Battery Holder
DFJ201	
DFJ211 DFJ216 DFJ300 DFJ416 DFJ311 DFV214A DFJ400 DFV210 DFJ411 FJ502D DFJ212 FJ203D DFJ213 FJ301D DFJ214 FJ401D	 Battery Holder Set Part No. 198732-2
DCV202 DCB200	 Battery Holder Set Part No. YL00000004
DCV202 CB100D	 Battery Holder Set Part No. YL00000003
DFV214A	 Battery Holder Set Part No. TD00000111

Jacket Size

saiz Jaket 夹克尺寸



Fan Vest	size (in cm)	S	M	L	XL	2XL	3XL
DFV210 DFV214A	Length	67	69	71	72	73	74
	Shoulder	43	45	47	49	51	53
	Chest	113	118	123	128	133	138
	Waist	107	112	117	122	127	132

Heated Vest	size (in cm)	S	M	L	XL	2XL	3XL
DCV202	Length	72	73	74	75	76	77
	Shoulder	47.5	49.5	51.5	53.5	55.5	57.5
	Chest	114	120	126	132	138	144
	Waist	116	122	128	134	140	146

Fan Jacket

	size (in cm)	S	M	L	XL	2XL	3XL
DFJ212	Length	66	68	70	71	72	73
	Shoulder	44	46	48	50	52	54
	Sleeve*	87	90	93	95	97	99
	Chest	117	122	127	132	137	142
DFJ213	Waist	111	116	121	126	131	136
	Length	65	67	69	70	71	72
	Shoulder	47	49	51	53	55	57
	Sleeve	62	64	66	67	68	69
DFJ214 DFJ214O	Chest	117	122	127	132	137	142
	Waist	103 ~ 111	108 ~ 116	113 ~ 121	118 ~ 126	123 ~ 131	128 ~ 136
	Length	68	70	72	73	74	75
	Shoulder	47	49	51	53	55	57
DFJ216	Sleeve	62	64	66	67	68	69
	Chest	119	124	129	134	139	144
	Waist	89 ~ 113	94 ~ 118	99 ~ 123	104 ~ 128	109 ~ 133	114 ~ 138
	Length	65	67	69	70	71	72
DFJ416	Shoulder	47	49	51	53	55	57
	Sleeve	62	64	66	67	68	69
	Chest	119	124	129	134	139	144
	Waist	103 ~ 113	108 ~ 118	113 ~ 123	118 ~ 128	123 ~ 133	128 ~ 138
DFJ211 DFJ311 DFJ411	Length	68	70	72	74	76	78
	Shoulder	56.5	59	61.5	64	66.5	69
	Sleeve	58	60	62	64	66	68
	Chest	126	131	136	141	146	151
Waist	87 ~ 113	92 ~ 113	97 ~ 113	102 ~ 133	107 ~ 138	112 ~ 143	

* All list price shown are for reference only (exclude SST).

* Semua harga yang ditunjukkan adalah untuk rujukan sahaja (tidak termasuk SST). 所有显示的建议零售价仅供参考 (不包括SST)。

Cordless Temperature Meter
LED Flashlight
Vacuum Cleaner
Drilling / Fastening
Impact Drilling / Demolition
Cutting
Grinding / Smoothing
Sawing
Planing / Routing
Others
Outdoor Power Equipment



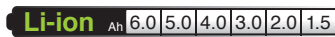

DFJ216ZL 18V / 12Vmax
RM 710

Cordless Fan Jacket
Jaket Kipas Tanpa Kord
充电式风扇夹克



L



- Equipped with Two Flat Fan Units with BL Motor for Increased Comfort

• Without Charger & Battery



Air Flow Settings

Tetapan Aliran Udara 空气流量设置

Turbo | High | Medium | Low

Air Flow

Aliran Udara 空气流量

Turbo: 2.2m³/min | High: 2.1m³/min | Med: 1.7m³/min | Low: 1.5m³/min

Size

Saiz 尺寸

L

Pockets

Poket 口袋

5

Net Weight

Berat Bersih 淨重

0.23kg (N/A lbs.)

Continuous Usage Time (approx.)

Masa Penggunaan Berterusan 连续使用时间

Low: 27.5 hrs | Medium : 20 hrs | High: 11 hrs with BL1850B

Polyester

- High repellency fabric

DFJ416ZL 18V / 12Vmax
RM 943

Cordless Fan Jacket
Jaket Kipas Tanpa Kord
充电式风扇夹克



L



- Equipped with Two Flat Fan Units with BL Motor for Increased Comfort

• Without Charger & Battery



Air Flow Settings

Tetapan Aliran Udara 空气流量设置

Turbo | High | Medium | Low

Air Flow

Aliran Udara 空气流量

Turbo: 2.2m³/min | High: 2.1m³/min | Med: 1.7m³/min | Low: 1.5m³/min

Size

Saiz 尺寸

L

Pockets

Poket 口袋

5

Net Weight

Berat Bersih 淨重

0.23kg (N/A lbs.)

Continuous Usage Time (approx.)

Masa Penggunaan Berterusan 连续使用时间

Low: 27.5 hrs | Medium : 20 hrs | High: 11 hrs with BL1850B

Polyester + Titanium coating

- Reflects infrared rays and ultraviolet rays

DFJ211ZM | DFJ211ZL | DFJ211ZXL 18V / 12Vmax
RM 762 | RM 762 | RM 762

Cordless Fan Jacket
Jaket Kipas Tanpa Kord
充电式风扇外套



M / L / XL



- Equipped with Two Flat Fan Units with BL Motor for Increased Comfort

• Without Charger & Battery



Air Flow Settings

Tetapan Aliran Udara 空气流量设置

Turbo | High | Medium | Low

Air Flow

Aliran Udara 空气流量

Turbo: 2.2m³/min | High: 2.1m³/min | Med: 1.7m³/min | Low: 1.5m³/min

Size

Saiz 尺寸

M | L | XL

Pockets

Poket 口袋

5

Net Weight

Berat Bersih 淨重

0.41kg (0.9lbs.)

Continuous Usage Time (approx.)

Masa Penggunaan Berterusan 连续使用时间

Low: 29 hrs | Medium: 21 hrs | High: 12 hrs with BL1850B

Polyester

For general work

Untuk kerja am | 用于一般工作

- Superior moisture permeability and water repellent

DFJ311ZM | DFJ311ZL | DFJ311ZXL 18V / 12Vmax
RM 800 | RM 800 | RM 800

Cordless Fan Jacket
Jaket Kipas Tanpa Kord
充电式风扇外套



M / L / XL



- Equipped with Two Flat Fan Units with BL Motor for Increased Comfort

• Without Charger & Battery



Air Flow Settings

Tetapan Aliran Udara 空气流量设置

Turbo | High | Medium | Low

Air Flow

Aliran Udara 空气流量

Turbo: 2.2m³/min | High: 2.1m³/min | Med: 1.7m³/min | Low: 1.5m³/min

Size

Saiz 尺寸

M | L | XL

Pockets

Poket 口袋

5

Net Weight

Berat Bersih 淨重

0.52kg (1.1lbs.)

Continuous Usage Time (approx.)

Masa Penggunaan Berterusan 连续使用时间

Low: 29 hrs | Medium: 21 hrs | High: 12 hrs with BL1850B

Cotton

For welding/ grinding work

Untuk kerja kimpalan/ pengisaran | 用于焊接/ 打磨工作

- Strong in heat and sparks

DFJ411ZM | DFJ411ZL | DFJ411ZXL 18V / 12Vmax
RM 965 | RM 965 | RM 965

Cordless Fan Jacket
Jaket Kipas Tanpa Kord
充电式风扇外套



M / L / XL



- Equipped with Two Flat Fan Units with BL Motor for Increased Comfort

• Without Charger & Battery



Air Flow Settings

Tetapan Aliran Udara 空气流量设置

Turbo | High | Medium | Low

Air Flow

Aliran Udara 空气流量

Turbo: 2.2m³/min | High: 2.1m³/min | Med: 1.7m³/min | Low: 1.5m³/min

Size

Saiz 尺寸

M | L | XL

Pockets

Poket 口袋

5

Net Weight

Berat Bersih 淨重

0.49kg (1.1lbs.)

Continuous Usage Time (approx.)

Masa Penggunaan Berterusan 连续使用时间

Low: 29 hrs | Medium: 21 hrs | High: 12 hrs with BL1850B

Polyester + Titanium coating

For outdoor work

Untuk kerja luaran | 用于户外工作

- Reflective in ultraviolet rays and infrared rays

* All list price shown are for reference only (exclude SST).

* Semua harga yang ditunjukkan adalah untuk rujukan sahaja (tidak termasuk SST). 所有显示的建议零售价仅供参考 (不包括SST)。

Cordless
Terdapat Kordless

LED Flashlight
Lampu Cahaya LED
LED BATERAI

Vacuum Cleaner
Penyedut Haba
VACUUM

Drilling / Fastening
Dua / Pengikat
MUTU / 釘

Impact Drilling / Demolition
Dua / Demolish
Dua / 釘

Cutting / Penamping
Dua / Penamping
Dua / 釘

Grinding / Sanding
Dua / Sanding
Dua / 釘

Sawing
Dua / Sawing
Dua / 釘

Planing / Routing
Dua / Routing
Dua / 釘

Others
Lain-lain
Lain-lain

Outdoor Power Equipment
Alat Kuasa Luar
MOTOR

Makita
MOTOR



FJ502DZM RM 1,278 | **FJ502DZL** RM 1,278 | **FJ502DZLL** RM 1,278 | 18V / 12Vmax

Cordless Fan Jacket
Jaket Kipas Tanpa Kord
充电式风扇外套



- Equipped with Two Flat Fan Units with BL Motor for Increased Comfort

M / L / LL

• Without Charger & Battery



Air Flow Settings Tetapan Aliran Udara 空气流量设置	Turbo High Medium Low
Air Flow Aliran Udara 空气流量	Turbo: 2.2m³/min High: 2.1m³/min Med: 1.7m³/min Low: 1.5m³/min
Size Saiz 尺寸	M L LL

DFJ214OM RM 1,202 | **DFJ214OL** RM 1,202 | **DFJ214OXL** RM 1,202 | **DFJ214O2XL** RM 1,202 | 18V / 12Vmax

Cordless Fan Jacket
Jaket Kipas Tanpa Kord
充电式风扇夹克



- Equipped with Two Flat Fan Units with BL Motor for Increased Comfort

M / L / XL / 2XL

• Without Charger & Battery



Air Flow Settings Tetapan Aliran Udara 空气流量设置	Turbo High Medium Low
Air Flow Aliran Udara 空气流量	Turbo: 2.2m³/min High: 2.1m³/min Med: 1.7m³/min Low: 1.5m³/min
Size Saiz 尺寸	M L XL 2XL
Pockets Poket 口袋	5
Net Weight Berat Bersih 净重	0.54kg (1.2lbs.)
Continuous Usage Time (approx.) Masa Penggunaan Berterusan 连续使用时间	Low: 27.5 hrs Medium : 20 hrs High: 11 hrs with BL1850B

Polyester

- water repellency, antistatic fabric

DFJ214ZM RM 1,202 | **DFJ214ZL** RM 1,202 | **DFJ214ZXL** RM 1,202 | 18V / 12Vmax

Cordless Fan Jacket
Jaket Kipas Tanpa Kord
充电式风扇外套



- Equipped with Two Flat Fan Units with BL Motor for Increased Comfort

M / L / XL

• Without Charger & Battery



Air Flow Settings Tetapan Aliran Udara 空气流量设置	Turbo High Medium Low
Air Flow Aliran Udara 空气流量	Turbo: 2.2m³/min High: 2.1m³/min Med: 1.7m³/min Low: 1.5m³/min
Size Saiz 尺寸	M L XL
Pockets Poket 口袋	5
Net Weight Berat Bersih 净重	0.54kg (1.2lbs.)
Continuous Usage Time (approx.) Masa Penggunaan Berterusan 连续使用时间	Low: 29 hrs Medium : 21 hrs High: 12 hrs with BL1850B

Polyester

- water repellency, antistatic fabric

DFJ212ZM RM 1,072 | **DFJ212ZL** RM 1,072 | **DFJ212ZXL** RM 1,072 | 18V / 12Vmax

Cordless Fan Jacket
Jaket Kipas Tanpa Kord
充电式风扇外套



- Equipped with Two Flat Fan Units with BL Motor for Increased Comfort

M / L / XL

• Without Charger & Battery



Air Flow Settings Tetapan Aliran Udara 空气流量设置	Turbo High Medium Low
Air Flow Aliran Udara 空气流量	Turbo: 2.2m³/min High: 2.1m³/min Med: 1.7m³/min Low: 1.5m³/min
Size Saiz 尺寸	M L XL
Pockets Poket 口袋	5
Net Weight Berat Bersih 净重	0.43kg (0.9lbs.)
Continuous Usage Time (approx.) Masa Penggunaan Berterusan 连续使用时间	Low: 29 hrs Medium : 21 hrs High: 12 hrs with BL1850B

Polyester

- High repellency fabric

DFJ213ZM RM 1,017 | **DFJ213ZL** RM 1,017 | **DFJ213ZXL** RM 1,017 | 18V / 12Vmax

Cordless Fan Jacket
Jaket Kipas Tanpa Kord
充电式风扇外套

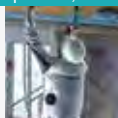

- Equipped with Two Flat Fan Units with BL Motor for Increased Comfort

M / L / XL

• Without Charger & Battery



Air Flow Settings Tetapan Aliran Udara 空气流量设置	Turbo High Medium Low
Air Flow Aliran Udara 空气流量	Turbo: 2.2m³/min High: 2.1m³/min Med: 1.7m³/min Low: 1.5m³/min
Size Saiz 尺寸	M L XL
Pockets Poket 口袋	5
Net Weight Berat Bersih 净重	0.54kg (1.2lbs.)
Continuous Usage Time (approx.) Masa Penggunaan Berterusan 连续使用时间	Low: 29 hrs Medium : 21 hrs High: 12 hrs with BL1850B

Polyester

- Stretchable fabric

* All list price shown are for reference only (exclude SST).

* Semua harga yang ditunjukkan adalah untuk rujukan sahaja (tidak termasuk SST). 所有显示的建议零售价仅供参考 (不包括SST)。





Li-ion Ah 6.0 5.0 4.0 3.0 2.0 1.5

DFV214A01 | DFV214A02 18V / 12Vmax
Price TBA | Price TBA

Cordless Fan Vest
Jaket Kipas Tanpa Kord
充电式风扇背心



NEW
BARU 新

- Two flatter fan units, higher voltage and redesigned air flow for increased air volume and comfort

• Without Charger & Battery

DFV214A01 (S-L)
DFV214A02 (XL-3L)



Air Flow Settings Tetapan Aliran Udara 空气流量设置	Turbo High Medium Low
Size Saiz 尺寸	01: S-L 02: XL-3L
Pockets Poket 口袋	4
Net Weight Berat Bersih 淨重	0.23kg
Continuous Usage Time (approx.) Masa Penggunaan Berterusan 连续使用时间	Low: 68 hrs Medium : 29.5 hrs High: 16 hrs Max: 10 hrs with BL1860B

Polyester

- High repellency fabric

DFV210ZM | DFV210ZL | DFV210ZXL | DFV210Z2XL 18V / 12Vmax
RM 873 | RM 873 | RM 873 | RM 873

Cordless Fan Vest
Jaket Kipas Tanpa Kord
充电式风扇背心



- Equipped with Two Flat Fan Units with BL Motor for Increased Comfort

• Without Charger & Battery

M / L / XL / 2XL



Air Flow Settings Tetapan Aliran Udara 空气流量设置	Turbo High Medium Low
Air Flow Aliran Udara 空气流量	Turbo: 2.2m³/min High: 2.1m³/min Med: 1.7m³/min Low: 1.5m³/min
Size Saiz 尺寸	M L XL
Pockets Poket 口袋	5
Net Weight Berat Bersih 淨重	0.38kg (0.8lbs.)
Continuous Usage Time (approx.) Masa Penggunaan Berterusan 连续使用时间	Low: 29 hrs Medium: 21 hrs High: 12 hrs with BL1850B

Polyester

- High repellency fabric

FJ203DZL | FJ203DZLL 18V / 12Vmax
RM 760 | RM 760

Cordless Fan Jacket
Jaket Kipas Tanpa Kord
充电式风扇外套



- Powerful fan provides air flow to keep you cool

Standard Equipment: Fan Hook

• Without Charger & Battery



L / LL

Air Flow Settings Tetapan Aliran Udara 空气流量设置	Turbo High Medium Low
Air Flow Aliran Udara 空气流量	Turbo: 1.4m³/min High: 1.2m³/min Med: 1.0m³/min Low: 0.8m³/min
Size Saiz 尺寸	L XL LL
Pockets Poket 口袋	5
Net weight Berat Bersih 淨重	1.5 - 1.9kg (3.3 - 4.1lbs)
Continuous Usage Time (approx.) Masa Penggunaan Berterusan 连续使用时间	Low: 28 hrs Medium: 20 hrs High: 11 hrs with BL1850B

Polyester

For general work

Untuk kerja am | 用于一般工作

- Superior moisture permeability and water repellent

DFJ300ZXL | FJ301DZM | FJ301DZL | FJ301DZLL 18V / 12Vmax
RM 745 | RM 797 | RM 797 | RM 797

Cordless Fan Jacket
Jaket Kipas Tanpa Kord
充电式风扇外套



- 100% cotton - hardly-burned, suitable for welding/ grinding

Standard Equipment: Fan Hook

• Without Charger & Battery



XL

M / L / LL

Air Flow Settings Tetapan Aliran Udara 空气流量设置	Turbo High Medium Low
Air Flow Aliran Udara 空气流量	Turbo: 1.4m³/min High: 1.2m³/min Med: 1.0m³/min Low: 0.8m³/min
Size Saiz 尺寸	DFJ300: XL FJ301: M L LL
Pockets Poket 口袋	5
Net weight Berat Bersih 淨重	1.5 - 1.9kg (3.3 - 4.1lbs)
Continuous Usage Time (approx.) Masa Penggunaan Berterusan 连续使用时间	Low: 29 hrs Medium: 21 hrs High: 12 hrs with BL1850B

Cotton

For welding/ grinding work

Untuk kerja kimpalan/ pengisaran | 用于焊接/ 打磨工作

- Strong in heat and sparks

DFJ400ZXL | FJ401DZL | FJ401DZLL | FJ401DZ3L 18V / 12Vmax
RM 848 | RM 970 | RM 970 | RM 970

Cordless Fan Jacket
Jaket Kipas Tanpa Kord
充电式风扇外套



- Heavy-duty shoulder pad lightens the burden on a shoulder and prevents torn while carrying reinforcing bars

Standard Equipment: Fan Hook

• Without Charger & Battery



XL

L / LL / 3L

Air Flow Settings Tetapan Aliran Udara 空气流量设置	Turbo High Medium Low
Air Flow Aliran Udara 空气流量	Turbo: 1.4m³/min High: 1.2m³/min Med: 1.0m³/min Low: 0.8m³/min
Size Saiz 尺寸	DFJ400: XL FJ401: L LL 3L
Pockets Poket 口袋	5
Net weight Berat Bersih 淨重	1.5 - 1.9kg (3.3 - 4.1lbs)
Continuous Usage Time (approx.) Masa Penggunaan Berterusan 连续使用时间	Low: 28 hrs Medium: 20 hrs High: 11 hrs with BL1850B

Polyester + Titanium processing

For outdoor work

Untuk kerja luaran | 用于户外工作

- Reflective in ultraviolet rays and infrared rays

* All list price shown are for reference only (exclude SST).

* Semua harga yang ditunjukkan adalah untuk rujukan sahaja (tidak termasuk SST). 所有显示的建议零售价仅供参考 (不包括SST)。

Cordless Target Kuching
LED Flashlight Lampu Cahaya LED
Vacuum Cleaner Penyedut Vakuum
Drilling / Fastening
Impact Drilling / Demolition
Cutting
Grinding / Sanding
Sawing
Planing / Routing
Oilers
Outdoor Power Equipment





DFJ201ZM | **DFJ201ZL** | **DFJ201ZXL** 18V
RM 710 | RM 710 | RM 710

Cordless Fan Jacket
Jaket Kipas Tanpa Kord
充电式风扇外套



- Stay cool in hot harsh job site environments

Standard Equipment: Battery Holder

- Without Charger & Battery



M / L / XL

Air Flow Settings Tetapan Aliran Udara 空气流量设置	Turbo High Medium Low
Air Flow Aliran Udara 空气流量	Turbo: 1.4m³/min High: 1.2m³/min Med: 1.0m³/min Low: 0.8m³/min
Size Saiz 尺寸	M L XL
Pockets Poket 口袋	3
Net weight Berat Bersih 淨重	660g (1.5lbs)
Continuous Usage Time (approx.) Masa Penggunaan Berterusan 连续使用时间	Low: 28 hrs Medium: 20 hrs High: 11 hrs with BL1850B

Polyester For general work
Untuk kerja am | 用于一般工作

- Superior moisture permeability and water repellent

DCV202YXL 18V
RM 940

Cordless Heated Vest
Ves Pemanas Tanpa Kord
充电式发热背心



- Stay warm in cold harsh job site environments

- Without Charger & Battery

XL

Heat Zones Tetapan Aliran Udara 發熱區域	Total: 4 Chest: 2 Back: 2
Heat Settings Aliran Udara 加熱設定	High Medium Low
Heat Value Aliran Udara 加熱值	High: 9.5W Mid : 4.5W Low: 2.3W
Size Saiz 尺寸	XL
Pockets Poket 口袋	4
Net Weight Berat Bersih 淨重	0.5kg (1.1lbs.)
Continuous Usage Time (approx.) Masa Penggunaan Berterusan 连续使用时间	Low: 29 hrs Medium: 17 hrs High: 8 hrs with BL1850B

Polyester

- High repellency fabric

Cordless Heated Blanket

Selimut Elektrik Tanpa Kord 充电式电热毯

1.5m Extension cord

Kabel sambungan 连接电缆



*Masa Penggunaan Berterusan 连续使用时间

Continuous Usage Time with BL1850B (Low Mode)

29hrs (approx.)



DCB200B 18V
RM 1,043

Cordless Heated Blanket
Selimut Elektrik Tanpa Kord
充电式电热毯

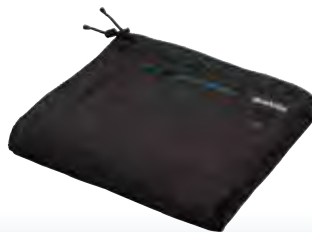

- Machine-washable and machine-dryable

Standard Equipment: Battery Holder, Storage Bag, Extension Cord

- Without Charger & Battery

Heat Zone Tetapan Aliran Udara 發熱區域	Upper Center: 1
Heat Settings Aliran Udara 加熱設定	High Medium Low
Heat Value Aliran Udara 加熱值	High: 9.5W Med: 4.5W Low: 2.3W
Dimensions (L x W) Dimensi 体积	700x1,400mm (27-1/2"x55")
Net Weight Berat Bersih 淨重	0.58kg (1.28lbs.)
Continuous Usage Time (approx.) Masa Penggunaan Berterusan 连续使用时间	Low: 29 hrs Med: 16.5 hrs High: 8 hrs with BL1850B

CB100DB 12Vmax
RM 1,043

Cordless Heated Blanket
Selimut Elektrik Tanpa Kord
充电式电热毯



- Machine-washable and machine-dryable

Standard Equipment: Battery Holder, Storage Bag, Extension Cord

- Without Charger & Battery

Heat Zone Tetapan Aliran Udara 發熱區域	Upper Center: 1
Heat Settings Aliran Udara 加熱設定	High Medium Low
Heat Value Aliran Udara 加熱值	High: 9.5W Med: 4.5W Low: 2.3W
Dimensions (L x W) Dimensi 体积	700x1,400mm (27-1/2"x55")
Net Weight Berat Bersih 淨重	0.58kg (1.28lbs.)
Continuous Usage Time (approx.) Masa Penggunaan Berterusan 连续使用时间	Low: 14 hrs Med: 7.5 hrs High: 4 hrs with BL1041B

* All list price shown are for reference only (exclude SST).

* Semua harga yang ditunjukkan adalah untuk rujukan sahaja (tidak termasuk SST). 所有显示的建议零售价仅供参考 (不包括SST)。



LED FLASHLIGHT

Lampu Suluh LED LED照明灯

Cordless
Kabelless

LED Flashlight
Lampu Suluh LED
LED照明灯

Vacuum Cleaner
Pembersih Vakuum

Drilling / Fastening
Drill / Pasang
M.D. / M.B.

Impact Drilling / Demolition
Drill / Pasang
D.T.M. / D.B.T.

Cutting
Potong

Grinding / Sanding
Ratakan / Halus

Sawing
Gigit

Planing / Routing
Ratakan / Tempam

Others
Lain

Outdoor Power Equipment
Alat-alat Luar Ruangan

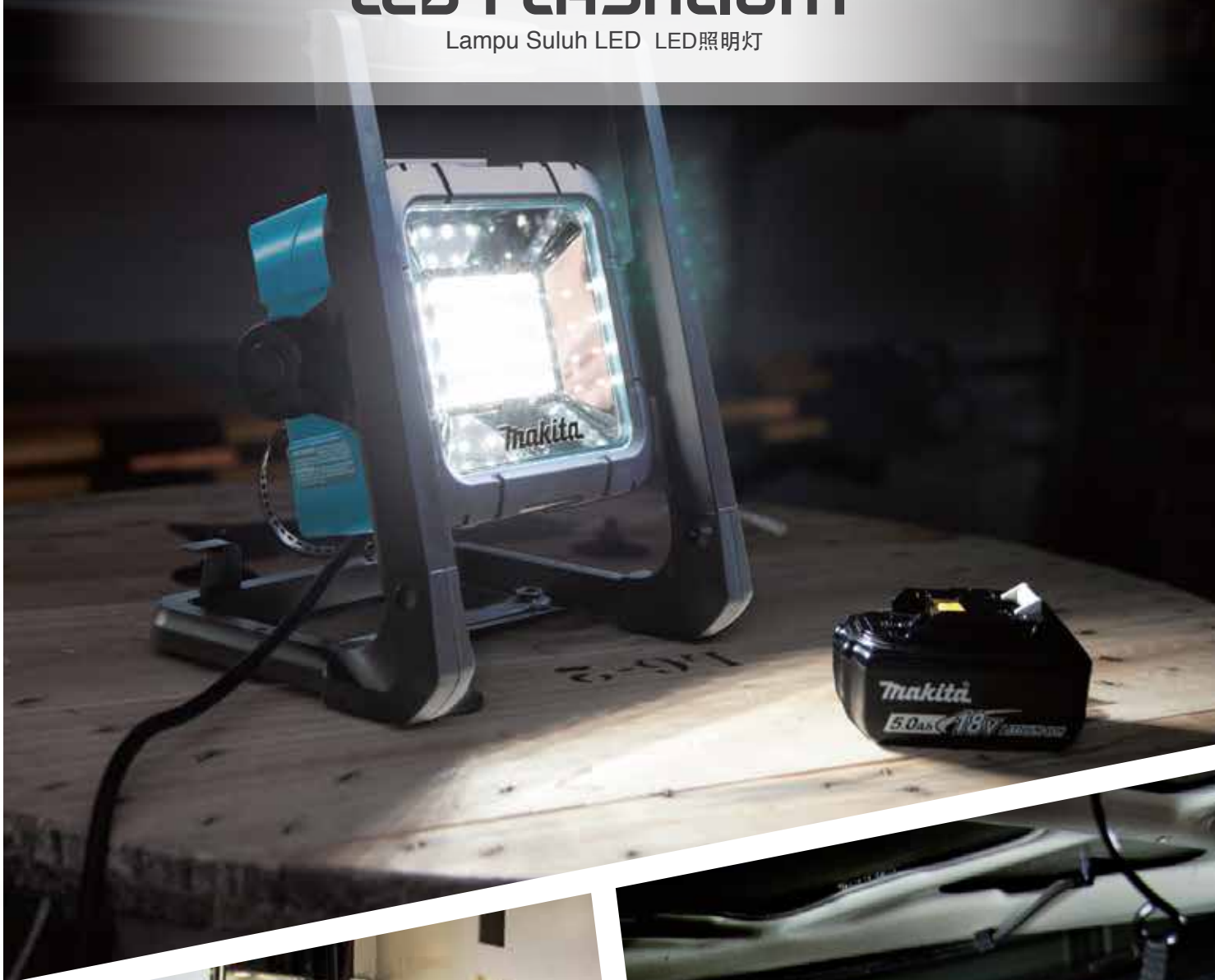

Cordless Area Worklight

Lampu Kerja Kawasan Tanpa Kord 充电式区域工作灯

IPX4
Water Resistance

Light Diffusing Lens
202 super luminous daylight white LEDs:
40.4W (0.2W x 202)

Inlet type AC power supply cord

Detachable and can be stored compactly on the back of the light body
Wayar elektrik boleh disimpan dengan padat di bahagian belakang badan lampu
电源线可紧凑地存放在灯体的背面

Switch

Panel Kawalan 控制面板

Reflector

Glow in the dark
Bercahaya dalam gelap
黑暗中发光

Adjustable illumination area

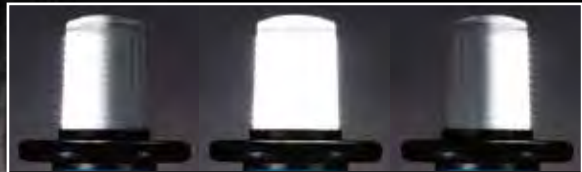

Controller with memory function remembers the brightness setting and the lighting area setting last time you power off, allowing the user to avoid adjusting again.
Pengawal dengan fungsi memori mengingat tetapan kecerahan dan tetapan kawasan pencahayaan ketika terakhir anda mematikan, membolehkan pengguna mengelakkan penyesuaian lagi.
具有存储功能的控制器会在您上次关闭电源时记住亮度设置和照明区域设置，从而使用户避免再次进行调整。

3-stage brightness switch



Low	Medium	High
1,500 lm	3,000 lm	5,500 lm
18 h	8.5 h	4.0 h

Continuous run time (Battery : BL1860Bx2)

DML810 18V / AC
Price TBA

Cordless Area Worklight
Lampu Kerja Kawasan Tanpa Kord
充电式区域工作灯



• Self-righting design won't fall over even if bumped

Standard Equipment: AC Power Cord

• Without Charger & Battery

Luminous Flux
Cahaya Fluks 发光通量
High: 5,500lm | Mid: 3,000lm | Low: 1,500lm

illumination
Pencahayaan 照度
at 1m from the light source: 550 / 300 / 150 lx
at 3m from the light source: 70 / 40 / 20 lx
at 5m from the light source: 25 / 15 / 7 lx

Dimensions (L x W x H)
Dimensi 体积
420x420x787mm
(16-1/2"x16-1/2"x31")

Net Weight
Berat Bersih 净重
13.9 - 15.3kg (30.6 - 33.7lbs.)

Continuous Usage Time (approx.)
Masa Penggunaan Berterusan 连续使用时间
18 hrs with BL1850B x2

DML808 (AUAML808) 18V
RM 329.50

Cordless LED Flashlight
Lampu Suluh LED Tanpa Kord
充电式LED工作灯

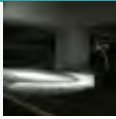

• Multifaceted Reflector Illuminates Evenly for Increased Visibility



DML808/ML106 Models and specs may vary by country

• Without Charger & Battery

Luminous Flux
Cahaya Fluks 发光通量
190lm

illumination
Pencahayaan 照度
at 1m from the light source: 170 - 4,500lx

Dimensions (L x W x H)
Dimensi 体积
297x79x119mm
(11-3/4"x3-1/8"x4-11/16")

Net Weight
Berat Bersih 净重
0.73 - 1.09kg (1.6 - 2.4lbs)

Continuous Usage Time (approx.)
Masa Penggunaan Berterusan 连续使用时间
26 hrs with BL1850B

DML807 (AUBDML807) 18V
Price TBA

Cordless LED Flashlight
Lampu Suluh LED Tanpa Kord
充电式LED手电筒

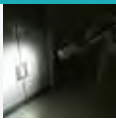

• USB power supply switch with auto-off function for saving battery power

• Without Charger & Battery

Main light (on bar side)
Lampu Utama 主灯
Luminous flux (Full brightness): 710 lm
Illuminance (Full brightness): 340 lx
Luminous flux (Half brightness): 340 lm
Illuminance (Half brightness): 310 lx

Sub light (on top side)
Lampu Tambahan 副灯
Luminous flux: 130 lm
Illuminance: 1,900 lx

Dimensions (L x W x H)
Dimensi 体积
414x79x155mm
(16-1/4"x3-1/8"x6-1/8")

Net Weight
Berat Bersih 净重
0.72 - 1.1kg (1.6 - 2.4lbs.)

Continuous Usage Time (approx.)
Masa Penggunaan Berterusan 连续使用时间
43 hrs with BL1850B



* All list price shown are for reference only (exclude SST).

* Semua harga yang ditunjukkan adalah untuk rujukan sahaja (tidak termasuk SST). 所有显示的建议零售价仅供参考 (不包括SST)。

Cordless
Tool Kit (TAK)

LED Flashlight
Lampu Suluh LED
LED08101

Vacuum Cleaner
Penyedut Debu
VC201

Drilling / Fastening
Gergasi / Pengikat
M12 / M16

Impact Drilling / Demolition
Gergasi / Pemusnah
E10M12 / M16

Cutting
Pemotong
CUT

Grinding / Sanding
Mojakan / Pasut
G10 / G12

Sawing
Dagat
S10

Planing / Routing
Papan / Terasan
R08 / R10

Others
Lain-lain
OT

Outdoor Power Equipment
Alatan Kuasa Luar
OPEP



18V

LXT

Li-ion Ah 6.0 5.0 4.0 3.0 2.0 1.5

Cordless Flashlight

Lampu Suluh Tanpa Kord 充电式照明灯



Variable-angle head
Sudut laras 可调整角度



Switch
Panel Kawalan 控制面板

4 Mode switch
Suis 4 Mod 4模式开关



Hook
cangkuk 钩



4 MODES

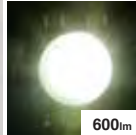

600m

Spot

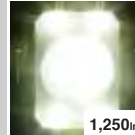

1,250m

Spot + Flood



1,000m

Flood



1,250m

Strobe

DML812 (TWADML812) 18V
Price TBA

Cordless Flashlight
Lampu Suluh Tanpa Kord
充电式工作灯



- Super luminous daylight white LEDs



Standard Equipment: **Strap Hook**

- Without Charger & Battery



DML802 (DEADML802) 18V
RM 319

Cordless LED Flashlight
Lampu Suluh LED Tanpa Kord
充电式LED工作灯

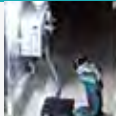

- 12 position pivoting flashlight head with positive stops from -60° - 110°



- Without Charger & Battery

DML801 (DEADML801) 18V
RM 297.70

Cordless LED Flashlight
Lampu Suluh LED Tanpa Kord
充电式LED手电筒

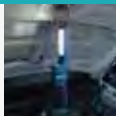

- Metal hang hook swivels 360° and folds away for extra convenience



- Without Charger & Battery

Luminous Flux Cahaya Fluks 发光通量	Spot: 600 lm Flood: 1,000 lm Spot-Flood: 1,250 lm
Illuminance Pencapaian 照度	Spot: 71,000 lx Flood: 520 lx Spot-Flood: 51,000 lx
Dimensions (L x W x H) Dimensi 体积	313x119x115mm (12-3/8"x4-11/16"x4-1/2")
Net Weight Berat Bersih 净重	1.2 - 1.6kg (2.6 - 3.4lbs.)
Continuous Usage Time (approx.) Masa Penggunaan Berterusan 连续使用时间	Spot: 8.5 hrs Flood: 6.5 hrs Spot-Flood: 5.0 hrs Strobe: 7.0 hrs with BL1850B

Dimensions (L x W x H) Dimensi 体积	272x79x116mm (10-3/4"x3-1/8"x4-9/16")
Net Weight Berat Bersih 净重	0.65kg (1.5lbs)
Continuous Usage Time (approx.) Masa Penggunaan Berterusan 连续使用时间	20 hrs with BL1850B

Dimensions (L x W x H) Dimensi 体积	380x79x116mm (15"x9-11/16"x4-9/16")
Net Weight Berat Bersih 净重	0.61 - 0.98kg (1.4 - 2.2lbs)
Continuous Usage Time (approx.) Masa Penggunaan Berterusan 连续使用时间	Full brightness: 20 hrs with BL1860B Half brightness: 48 hrs with BL1860B

* All list price shown are for reference only (exclude SST).

* Semua harga yang ditunjukkan adalah untuk rujukan sahaja (tidak termasuk SST). 所有显示的建议零售价仅供参考 (不包括SST)。

Cordless
Flashlight
Lampu Suluh LED
LED/LED
Vacuum Cleaner
Penjerap Vakuum
Drilling / Fastening
Datar / Pasang
Impact Drilling / Demolition
Datar / Penanggalan
Cutting
Memotong
Grinding / Sanding
Menggosok / Mengkilap
Sawing
Gergaji
Planing / Routing
Mengukir / Mengukir
Others
Lain-lain
Outdoor Power Equipment
Alatan Kuasa Luar





DML805 (GBBDML805) 18V / AC
RM 985.50

Corded and Cordless LED Worklight

Lampu Kerja LED Kuasa Elektrik dan Tanpa Kord
电源及充电式LED工作灯

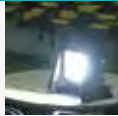

- 2-mode operation: delivers 750 lumens on high mode or 450 lumens on low mode

• Without Charger & Battery

Luminous Flux Cahaya Fluks 发光通量	Hi: 750lm, Lo: 450lm
Illuminance Pencahayaannya 照度	at 0.5m from the light source Hi: 1,150lx, Lo: 750lx at 1m from the light source Hi: 300lx, Lo: 200lx
Dimensions (L x W x H) Dimensi 体积	214x261x328mm (8-3/8"x10-1/4"x12-7/8")
Net Weight Berat Bersih 淨重	2.3 - 2.7kg (5.1 - 5.9lbs)
Continuous Usage Time (approx.) Masa Penggunaan Berterusan 连续使用时间	10.5 hrs with BL1850B

DML186 (DEADML186) 18V
RM 103.10

Cordless LED Flashlight
Lampu Suluh LED Tanpa Kord
充电式LED手电筒

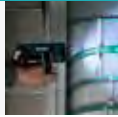

- Hand strap for extra convenience

• Without Charger & Battery

Dimensions (L x W x H) Dimensi 体积	151x81x61mm (5-7/8"x3-3/16"x2-3/8")
Net Weight Berat Bersih 淨重	0.51 - 0.83kg (1.1 - 1.8lbs)
Continuous Usage Time (approx.) Masa Penggunaan Berterusan 连续使用时间	50 hrs with BL1830B

ML104 (AUAML104) 12Vmax
Price TBA

Cordless LED Flashlight
Lampu Suluh LED Tanpa Kord
充电式LED手电筒

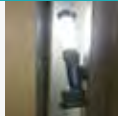

- USB power supply switch with auto-off function for saving battery power

• Without Charger & Battery



Main light (on bar side) Lampu Utama 主灯	Luminous flux (Full brightness): 710 lm Illuminance (Full brightness): 340 lx
Sub light (on top side) Lampu Tambahan 副灯	Luminous flux: 130 lm Illuminance: 1,900 lx
Dimensions (L x W x H) Dimensi 体积	414x66x132mm (16-1/4"x2-5/8"x5-3/16")
Net Weight Berat Bersih 淨重	0.61 - 0.78 kg (1.4 - 1.7 lbs.)
Continuous Usage Time (approx.) Masa Penggunaan Berterusan 连续使用时间	19 hrs with BL1041B

ML105 (AUAML105) 12Vmax
RM 303.70

Cordless LED Flashlight
Lampu Suluh LED Tanpa Kord
充电式LED工作灯

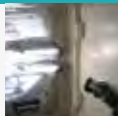

- Multifaceted Reflector Illuminates Evenly for Increased Visibility

Standard Equipment: Strap Hook

• Without Charger & Battery

Luminous Flux Cahaya Fluks 发光通量	190lm
Illuminance Pencahayaannya 照度	at 1m from the light source 5,500lx
Dimensions (L x W x H) Dimensi 体积	249x66x93mm (9-3/4"x2-5/8"x3-5/8")
Net Weight Berat Bersih 淨重	0.53 - 0.70kg (1.2 - 1.5lbs.)
Continuous Usage Time (approx.) Masa Penggunaan Berterusan 连续使用时间	7 hrs with BL1021B

ML106 (AUAML106) 12Vmax
RM 329.50

Cordless LED Flashlight
Lampu Suluh LED Tanpa Kord
充电式LED灯



- Multifaceted Reflector Illuminates Evenly for Increased Visibility

Standard Equipment: Strap Hook

• Without Charger & Battery



VIDEO CLIP
Models and specs may vary by country

DML808/ML106

* All list price shown are for reference only (exclude SST).

* Semua harga yang ditunjukkan adalah untuk rujukan sahaja (tidak termasuk SST). 所有显示的建议零售价仅供参考 (不包括SST)。

Cordless
18V/18V/18V

LED Flashlight
Lampu Suluh LED
LED808/81

Vacuum Cleaner
Penyedut Debu
VC101

Drilling / Fastening
Gasing / Pasak
M10 / M12

Impact Drilling / Demolition
Gasing / Pasak
G10/11 / G10/12

Cutting
Potong
CUT

Grinding / Sanding
Moles / Pasak
G10 / G12

Sanding
Giling
S10

Planing / Routing
Papan / Pasak
R10 / R12

Others
Lain-lain
O10

Outdoor Power Equipment
Alatan Pajuk Luar
O10 / O12





ML103 (AUAML103) 12Vmax
RM 175.50

Cordless LED Flashlight
Lampu Suluh LED Tanpa Kord
充电式LED灯



• 1.5W white single diffusion LED provides bright and wide illumination

• Without Charger & Battery

Dimensions (L x W x H) 77x54x28mm
(3x2-1/8x1-1/8")
Net Weight 0.27 - 0.43kg (0.6 - 1.0lbs)
Continuous Usage Time (approx.) 14 hrs with BL1021B
Masa Penggunaan Berterusan 连续使用时间

Product Comparison List

Senarai Perbandingan Produk 产品对比表

	18V	12V max	AC			
	DML808	ML106	DML802	ML105	DML801	DML186
	Zoom Function	Zoom Function				
Run time (hrs)	Up to: 26 with BL1850B	Up to: 12 with BL1041B	Up to: 23 with BL1850B	Up to: 14 with BL1041B	Up to: 20 Full: with BL1860B Up to: 48 Half: with BL1860B	Up to: 50 with BL1830B
Illuminance	170 - 4,500lx at 1m from the light	170 - 4,500lx at 1m from the light	4,000lx at 1m from the light	5,500lx at 1m from the light	Full: 400lx Half: 200lx at 0.5m from the light	500lx at 1m from the light
Luminous flux (lm=lumens)	190lm	190lm	180lm	190lm	Full: 240lm Half: 120lm	-
Net weight	0.73 - 1.09kg (1.6 - 2.4lbs)	0.61 - 0.78kg (1.3 - 1.7lbs)	0.64 - 1.0kg (1.4 - 2.2lbs)	0.53 - 0.70kg (1.2 - 1.5lbs)	0.61 - 0.98kg (1.4 - 2.2lbs)	0.51 - 0.83kg (1.1 - 1.8lbs)
	DML807	ML104	DML812	DML810	DML805	ML103
	XPT	XPT				
Run time (hrs)	Up to: 23 Main light (1/2) with BL1850B Up to: 36 Sub light with BL1850B	Up to: 17 Main light (1/2) with BL1041B Up to: 19 Sub light with BL1041B	Up to: 8 with BL1850B	Up to: 15 with BL1850B x2	Up to: 8.5 Hi: with BL1850B Up to: 17 Lo: with BL1850B	Up to: 28 with BL1041B
Illuminance	Main light (Full): 340lx Main light (1/2): 310lx Sub light (On Top): 1,900lx at 0.5m from the light	Main light (Full): 340lx Main light (1/4): 190lx Sub light (On Top): 1,900lx at 0.5m from the light	71,000lx 51,000lx 520lx at 1m from the light	550lx 300lx 150lx at 1m from the light	Hi: 1,150lx, Lo: 750lx at 0.5m from the light Hi: 300lx, Lo: 200lx at 1m from the light	240lx at 0.5m from the light 50lx at 1m from the light
Luminous flux (lm=lumens)	Main light (Full): 710lm Main light (1/2): 340lm Sub light (On Top): 130lm	Main light (Full): 710lm Main light (1/4): 190lm Sub light (On Top): 130lm	Spot: 600lm Spot/ Flood: 1,250lm Flood: 1,000lm	High: 5,500lm Med: 3,000lm Low: 1,500lm	Hi: 750lm Lo: 450lm	100lm
Net weight	0.72 - 1.1kg (1.6 - 2.4lbs)	0.61 - 0.78kg (1.4 - 1.7lbs)	1.7kg (3.8lbs)	13.9 - 15.3kg (30.6 - 33.7lbs)	2.3 - 2.7kg (5.1 - 5.9lbs)	0.27 - 0.43kg (0.6 - 1.0lbs)

* All list price shown are for reference only (exclude SST).

* Semua harga yang ditunjukkan adalah untuk rujukan sahaja (tidak termasuk SST). 所有显示的建议零售价仅供参考 (不包括SST)。

Cordless
LED Flashlight
Vacuum Cleaner
Drilling / Fastening
Impact Drilling / Demolition
Cutting
Grinding / Sanding
Sawing
Planing / Routing
Others
Outdoor Power Equipment



VACUUM CLEANER

Pembersih Vakum 吸尘器



Cordless
Brushless Motor

LED Flashlight
Battery Status LED
COMBIBIT

Vacuum Cleaner
Tempat Suci
吸尘器

Drilling | Finishing
Concrete / Tiles
SDS | SDS

Impact Drilling | Demolition
Chisel / Hammer
SDS-MX | SDS-MX

Cutting | Trimming
Plastic
UM

Grinding | Sanding
Metal / Plastic
SDS | SDS

Sanding
Disc
SDS

Planing | Routing
Plastic / Titanium
SDS | SDS

Chains
Saw
SDS

Outdoor Power Equipment
Auto-Feed Unit
SDS-CVT





Li-ion Ah 6.0 5.0 4.0 3.0 2.0 1.5

DVC150LZ

RM 6,217

Corded & Cordless Vacuum Cleaner (Wet & Dry)

Pembersih Vakum Kuasa Elektrik Dan Tanpa Kord (Basah dan Kering)
充电式 + 电源驱动吸尘器(干湿两用)



- For both wet and dry vacuum cleaning

Standard Equipment: Floor Nozzle, Corner Nozzle, Straight Pipe, Bent Pipe, Hose (38mm), Plastic Dust Bag, Plastic Dust Bag x10, Cloth Filter, Tool Box, Connection Cord

- LZ: Without Charger & Battery



Capacity Kapasiti 尘袋容量	Dust: 15L Water: 12L
Max Air Flow Aliran Udara 最大空气流量	AC: 3.6m ³ /min DC: 2.1m ³ /min
Max Sealed Suction Sedutan Terkedap 最大密封吸力	AC: 24kPa DC: 9kPa
Suction Power Kuasa Sedutan 吸力	AC: 320W DC: 25 - 70W
Dimensions (L x W x H) Dimensi 体积	366x334x421mm (14-3/8"x13-1/8"x16-1/2")
Net Weight Berat Bersih 净重	8.9 - 9.6kg (19.7 - 21.1lbs.)
Continuous Usage Time (approx.) Masa Penggunaan Berterusan 连续使用时间	40 min with BL1850B x2 (Speed Dial 5)

DVC151LZ

RM 7,038

Corded and Cordless Vacuum Cleaner (Dry)

Pembersih Vakum Kuasa Elektrik Dan Tanpa Kord (Kering)
充电式 + 电源驱动吸尘器(干用)



- 15L Large dust bag capacity

Standard Equipment: Floor Nozzle, Corner Nozzle, Straight Pipe, Bent Pipe, Hose (38mm), Hose (28mm), Front Cuffs (22, 24, 28), Plastic Dust Bag, Plastic Dust Bag x10, Cloth Filter, Damper, Dry Powder Filter, Tool Box, Connection Cord

- LZ: Without Charger & Battery



Capacity Kapasiti 尘袋容量	Dust: 15L
Max Air Flow Aliran Udara 最大空气流量	AC: 3.6m ³ /min DC: 2.1m ³ /min
Max Sealed Suction Sedutan Terkedap 最大密封吸力	AC: 24kPa DC: 9kPa
Suction Power Kuasa Sedutan 吸力	AC: 320W DC: 25 - 70W
Dimensions (L x W x H) Dimensi 体积	366x334x421mm (14-3/8"x13-1/8"x16-1/2")
Net Weight Berat Bersih 净重	9.6 - 10.3kg (21.2 - 22.6lbs.)
Continuous Usage Time (approx.) Masa Penggunaan Berterusan 连续使用时间	65 min with BL1850B x2

DVC152LZ

RM 4,843

Cordless Vacuum Cleaner (Wet & Dry)

Pembersih Vakum Tanpa Kord (Basah dan Kering)
充电式吸尘器(干湿两用)



- For both wet and dry vacuum cleaning

Standard Equipment: Floor Nozzle, Corner Nozzle, Straight Pipe, Bent Pipe, Hose (38mm), Plastic Dust Bag, Plastic Dust Bag x10, Cloth Filter, Tool Box

- LZ: Without Charger & Battery



Capacity Kapasiti 尘袋容量	Dust: 15L Water: 12L
Max Air Flow Aliran Udara 最大空气流量	2.1m ³ /min
Max Sealed Suction Sedutan Terkedap 最大密封吸力	9.8kPa
Suction Power Kuasa Sedutan 吸力	90W
Dimensions (L x W x H) Dimensi 体积	366x334x421mm (14-3/8"x13-1/8"x16-1/2")
Net Weight Berat Bersih 净重	7.3 - 7.9kg (16.0 - 17.4lbs.)
Continuous Usage Time (approx.) Masa Penggunaan Berterusan 连续使用时间	40 min with BL1850B x2

DVC153LZ

RM 5,665

Cordless Vacuum Cleaner (Dry)

Pembersih Vakum Tanpa Kord (Kering)
充电式吸尘器(干用)



- 15L Large dust bag capacity

Standard Equipment: Floor Nozzle, Corner Nozzle, Straight Pipe, Bent Pipe, Hose (38mm), Hose (28mm), Front Cuffs (22, 24, 28), Plastic Dust Bag, Plastic Dust Bag x10, Cloth Filter, Damper, Dry Powder Filter

- LZ: Without Charger & Battery



Capacity Kapasiti 尘袋容量	Dust: 15L
Max Air Flow Aliran Udara 最大空气流量	2.1m ³ /min
Max Sealed Suction Sedutan Terkedap 最大密封吸力	9.8kPa
Suction Power Kuasa Sedutan 吸力	90W
Dimensions (L x W x H) Dimensi 体积	366x334x421mm (14-3/8"x13-1/8"x16-1/2")
Net Weight Berat Bersih 净重	8.0 - 8.6kg (17.6 - 19.0lbs.)
Continuous Usage Time (approx.) Masa Penggunaan Berterusan 连续使用时间	40 min with BL1850B x2

DVC154LZ | DVC154LZX

RM 7,365

RM 6,508

Cordless Vacuum Cleaner (Dry)

Pembersih Vakum Tanpa Kord (Kering)
充电式吸尘器(干用)



- Auto-Start Wireless System (AWS) Connects to Power Tool with Bluetooth

Standard Equipment: DVC154LZ: Floor Nozzle, Corner Nozzle, Straight Pipe, Bent Pipe, Hose (38mm-2.5m), Plastic Dust Bag, Plastic Dust Bag x10, Cloth Filter, Front Cuffs, Dry Powder Filter, Damper, Wireless Unit (Build-in)

DVC154LZX: Hose (38mm-2.5m), Plastic Dust Bag, Plastic Dust Bag x10, Cloth Filter, Front Cuffs, Dry Powder Filter, Damper, Wireless Unit (Build-in)

- LZ / LZX: Without Charger & Battery



Capacity Kapasiti 尘袋容量	Dust: 15L
Max Air Flow Aliran Udara 最大空气流量	2.1m ³ /min
Max Sealed Suction Sedutan Terkedap 最大密封吸力	9.8kPa
Suction Power Kuasa Sedutan 吸力	90W
Dimensions (L x W x H) Dimensi 体积	366x334x421mm (14-3/8"x13-1/8"x16-1/2")
Net Weight Berat Bersih 净重	8.0 - 8.6kg (17.6 - 19.0lbs.)
Continuous Usage Time (approx.) Masa Penggunaan Berterusan 连续使用时间	40 min with BL1850B x2

* All list price shown are for reference only (exclude SST).

* Semua harga yang ditunjukkan adalah untuk rujukan sahaja (tidak termasuk SST). 所有显示的建议零售价仅供参考 (不包括SST)。

Cordless
LED Flashlight
Vacuum Cleaner
Drilling / Fastening
Impact Drilling / Demolition
Cutting / Pressing
Grinding / Sanding
Sawing
Planing / Routing
Others
Outdoor Power Equipment





Li-ion Ah 6.0 5.0 4.0 3.0 2.0 1.5

DVC155LZX3

RM 4,132

Cordless Vacuum Cleaner (Wet & Dry)

Pembersih Vakum Tanpa Kord (Basah dan Kering)
充电式吸尘器(干湿两用)

- More Powerful Suction Power



Standard Equipment: Floor Nozzle, Long Sash Nozzle, Telescopic Pipe Assembly, Bent Pipe, Pipe, Hose, Plastic Dust Bag x10, Filter, Tool Box, Plastic Dust Bag

- LZX3: Without Charger & Battery



Capacity Kapasiti 尘袋容量	Dust: 15L Water: 12L
Max Air Flow Aliran Udara 最大空气流量	2.1m³/min
Max Sealed Suction Sedutan Terkedap 最大密封吸力	11kPa
Suction Power Kuasa Sedutan 吸力	105W
Dimensions (L x W x H) Dimensi 体积	366x334x421mm (14-3/8"x13-1/8"x16-1/2")
Net Weight Berat Bersih 净重	7.2 - 7.9kg (15.9 - 17.4lbs.)
Continuous Usage Time (approx.) Masa Penggunaan Berterusan 连续使用时间	83 min with BL1850B x2

DVC157LZX5

RM 5,932

Cordless Vacuum Cleaner (Dry)

Pembersih Vakum Tanpa Kord (Kering)
充电式吸尘器(干用)

- Auto-start Wireless System (AWS) connects to power tool with Bluetooth



Standard Equipment: Floor Nozzle, Corner Nozzle, Straight Pipe, Bent Pipe, Hose (38mm-2.5m), Plastic Dust Bag, Plastic Dust Bag x10, Cloth Filter, Tool Box, Damper, Dry Powder Filter

- LZX5: Without Charger & Battery



Capacity Kapasiti 尘袋容量	Dust: 15L
Max Air Flow Aliran Udara 最大空气流量	2.4m³/min
Max Sealed Suction Sedutan Terkedap 最大密封吸力	11kPa
Suction Power Kuasa Sedutan 吸力	110W
Dimensions (L x W x H) Dimensi 体积	366x334x421mm (14-3/8"x13-1/8"x16-1/2")
Net Weight Berat Bersih 净重	8.0 - 8.6kg (17.6 - 19.0lbs.)
Continuous Usage Time (approx.) Masa Penggunaan Berterusan 连续使用时间	83 min with BL1850B x2

DVC860LZ

RM 4,607

Cordless & Corded Vacuum Cleaner (Wet & Dry)

Pembersih Vakum Kuasa Elektrik Dan Tanpa Kord (Basah dan Kering)
充电式 + 电源驱动吸尘器(干湿两用)

- Cloth filter type: for both wet & dry vacuum cleaning

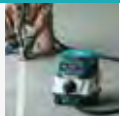

Standard Equipment: Floor Nozzle, Corner Nozzle, Straight Pipe, Bent Pipe, Hose (38mm), Plastic Dust Bag, Plastic Dust Bag x10, Cloth Filter, Tool Box, Connection Cord

- LZ: Without Charger & Battery



Capacity Kapasiti 尘袋容量	Dust: 8L Water: 6L
Max Air Flow Aliran Udara 最大空气流量	AC: 3.6m³/min DC: 2.1m³/min
Max Sealed Suction Sedutan Terkedap 最大密封吸力	AC: 24kPa DC: 9kPa
Suction Power Kuasa Sedutan 吸力	AC: 320W DC: 25 - 70W
Dimensions (L x W x H) Dimensi 体积	366x334x368mm (14-3/8"x13-1/8"x14-1/2")
Net Weight Berat Bersih 净重	8.6kg (19.0lbs.)
Continuous Usage Time (approx.) Masa Penggunaan Berterusan 连续使用时间	65 min with BL1850B x2

DVC862LPT2 **DVC862LRT2** **DVC862LZ**

RM 5,307

RM 5,007

RM 3,720

Cordless Vacuum Cleaner (Wet & Dry)

Pembersih Vakum Tanpa Kord (Basah dan Kering)
充电式吸尘器(干湿两用)

- For both wet and dry vacuum cleaning

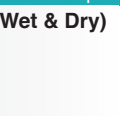

Standard Equipment: Floor Nozzle, Corner Nozzle, Straight Pipe, Bent Pipe, Hose (38mm), Plastic Dust Bag, Plastic Dust Bag x10, Cloth Filter, Tool Box

- LPT2: 1x Two Port Multi Fast Charger, 2x 5.0Ah Battery
- LRT2: 1x Rapid Charger, 2x 5.0Ah Battery
- LZ: Without Charger & Battery



Capacity Kapasiti 尘袋容量	Dust: 8L Water: 6L
Max Air Flow Aliran Udara 最大空气流量	2.1m³/min
Max Sealed Suction Sedutan Terkedap 最大密封吸力	9.8kPa
Suction Power Kuasa Sedutan 吸力	90W
Dimensions (L x W x H) Dimensi 体积	366x334x368mm (14-3/8"x13-1/8"x14-1/2")
Net Weight Berat Bersih 净重	7.0kg (15.5lbs.)
Continuous Usage Time (approx.) Masa Penggunaan Berterusan 连续使用时间	40 min with BL1850B x2

DVC863LPT2 **DVC863LRT2** **DVC863LZ**

RM 5,918

RM 5,618

RM 4,333

Cordless Vacuum Cleaner (Dry)

Pembersih Vakum Tanpa Kord (Kering)
充电式吸尘器(干用)

- 8L Large dust bag capacity enables continuous cleaning work

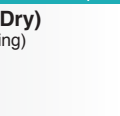

Standard Equipment: Floor Nozzle, Corner Nozzle, Straight Pipe, Bent Pipe, Hose 28mm, Front Cuffs (22, 24, 38), Plastic Dust Bag, Plastic Dust Bag x10, Cloth Filter, Tool Box

- LPT2: 1x Two Port Multi Fast Charger, 2x 5.0Ah Battery
- LRT2: 1x Rapid Charger, 2x 5.0Ah Battery
- LZ: Without Charger & Battery



Capacity Kapasiti 尘袋容量	Dust: 8L
Max Air Flow Aliran Udara 最大空气流量	2.1m³/min
Max Sealed Suction Sedutan Terkedap 最大密封吸力	9.8kPa
Suction Power Kuasa Sedutan 吸力	90W
Dimensions (L x W x H) Dimensi 体积	366x334x368mm (14-3/8"x13-1/8"x14-1/2")
Net Weight Berat Bersih 净重	7.7kg (17.1lbs.)
Continuous Usage Time (approx.) Masa Penggunaan Berterusan 连续使用时间	40 min with BL1850B x2

* All list price shown are for reference only (exclude SST).

* Semua harga yang ditunjukkan adalah untuk rujukan sahaja (tidak termasuk SST). 所有显示的建议零售价仅供参考 (不包括SST)。

Cordless
LED Flashlight
Vacuum Cleaner
Drilling / Finishing
Impact Drilling / Demolition
Cutting / Grinding
Grinding / Sanding
Sanding
Planing / Routing
Chain Saw
Circular Saw
Circular Saw





Li-ion Ah 6.0 5.0 4.0 3.0 2.0 1.5

DVC864LZ

RM 4,878

Cordless Vacuum Cleaner (Dry)

Pembersih Vakum Tanpa Kord (Kering)
充电式吸尘器(干用)



- Auto-Start Wireless System (AWS) Connects to Power Tool with Bluetooth

Standard Equipment: Floor Nozzle, Corner Nozzle, Straight Pipe, Bent Pipe, Hose (38mm), Front Cuffs (22, 24, 28), Plastic Dust Bag, Plastic Dust Bag x10, Cloth Filter, Tool Box, Wireless Unit (Build-in)

- LZ: Without Charger & Battery



Capacity Kapasiti 尘袋容量	Dust: 8L
Max Air Flow Aliran Udara 最大空气流量	2.1m³/min
Max Sealed Suction Sedutan Terkedayap 最大密封吸力	9.8kPa
Suction Power Kuasa Sedutan 吸力	90W
Dimensions (L x W x H) Dimensi 体积	366x334x368 mm (14-3/8"x13-1/8"x14-1/2")
Net Weight Berat Bersih 净重	7.7 - 8.4 kg (17.1 - 18.4 lbs.)
Continuous Usage Time (approx.) Masa Penggunaan Berterusan 连续使用时间	40 min with BL1850B x2

DVC865LZX3

RM 4,060

Cordless Vacuum Cleaner (Wet & Dry)

Pembersih Vakum Tanpa Kord (Basah dan Kering)
充电式吸尘器(干湿两用)



- For both wet and dry vacuum cleaning

Standard Equipment: Floor Nozzle, Long Sash Nozzle, Telescopic Pipe Assembly, Bent Pipe, Pipe, Hose, Plastic Dust Bag x10, Filter, Tool Box

- LZX3: Without Charger & Battery



Capacity Kapasiti 尘袋容量	Dust: 8L Water: 6L
Max Air Flow Aliran Udara 最大空气流量	2.1m³/min
Max Sealed Suction Sedutan Terkedayap 最大密封吸力	11kPa
Suction Power Kuasa Sedutan 吸力	105W
Dimensions (L x W x H) Dimensi 体积	366x334x368mm (14-3/8"x13-1/8"x14-1/2")
Net Weight Berat Bersih 净重	7.0 - 7.7kg (15.4 - 17.0lbs.)
Continuous Usage Time (approx.) Masa Penggunaan Berterusan 连续使用时间	83 min with BL1850B x2 Dial Mode 1

DVC867LZX1

RM 5,815

Cordless Vacuum Cleaner (Dry)

Pembersih Vakum Tanpa Kord (Kering)
充电式吸尘器(干用)



- Auto-start Wireless System (AWS) connects to power tool with Bluetooth

Standard Equipment: Floor Nozzle, Corner Nozzle, Straight Pipe, Bent Pipe, Hose (38mm-2.5m), Plastic Dust Bag, Plastic Dust Bag x10 (195432-5), Cloth Filter, Tool Box

- LZX1: Without Charger & Battery



Capacity Kapasiti 尘袋容量	Dust: 8L
Max Air Flow Aliran Udara 最大空气流量	2.4m³/min
Max Sealed Suction Sedutan Terkedayap 最大密封吸力	11kPa
Suction Power Kuasa Sedutan 吸力	110W
Dimensions (L x W x H) Dimensi 体积	366x334x368mm (14-3/8"x13-1/8"x14-1/2")
Net Weight Berat Bersih 净重	7.7 - 8.4kg (17.0 - 18.5lbs.)
Continuous Usage Time (approx.) Masa Penggunaan Berterusan 连续使用时间	83 min with BL1850B x2 Dial Mode 1

DVC265ZX

RM 3,343

Cordless Backpack Vacuum Cleaner

Pembersih Vakum Beg Galas Tanpa Kord
充电式背负吸尘器



- Increased suction power for improved dust collection

Standard Equipment: Hose, Hose Band, Dust Bag, Front Cuffs (22, 24)

- ZX: Without Charger & Battery



Capacity Kapasiti 尘袋容量	Paper Dust Bag: 2.0L Cloth Dust Bag: 1.5L
Max Air Flow Aliran Udara 最大空气流量	w/ Hose Complete 28-1.0: 2.0m³/min w/ Hose Complete 28-1.5: 1.8m³/min
Max Sealed Suction Sedutan Terkedayap 最大密封吸力	11kPa
Suction Power Kuasa Sedutan 吸力	w/ Hose 28-1.0: High: 90W Normal: 45W w/ Hose 28-1.5: High: 85W Normal: 45W
Dimensions (L x W x H) Dimensi 体积	230x152x373mm (9"x6"x14-3/4")
Net Weight Berat Bersih 净重	3.9 - 4.5kg (8.6 - 10.0lbs.)
Continuous Usage Time (approx.) Masa Penggunaan Berterusan 连续使用时间	High: 33 min Low: 62 min with BL1850B x2

DVC261Z

RM 2,577

Cordless Backpack Vacuum Cleaner

Pembersih Vakum Beg Galas Tanpa Kord
充电式背负吸尘器



- Increased Suction Power for Improved Dust Collection

Standard Equipment: HEPA Filter Assembly, Hose Band, Paper Filter Bag (2L), Hose (28mm), Floor Nozzle, Flexible Rubber Nozzle, Telescopic Pipe Assembly, Bent Pipe

- Z: Without Charger & Battery



DVC261

Models and specs may vary by country



Capacity Kapasiti 容量	Paper Dust Bag: 2.0L Cloth Dust Bag: 1.5L
Max Air Flow Aliran Udara 最大空气流量	w/ Hose complete 38-1.5: 2.2 m³/min w/ Hose complete 32-1.0: 2.2 m³/min w/ Hose Complete 28-1.0: 2.0 m³/min w/ Hose Complete 28-1.5: 1.8 m³/min
Max Sealed Suction Sedutan Terkedayap 最大密封吸力	11 kPa
Suction Power Kuasa Sedutan 吸力	Max/ High/ Normal w/ Hose 38-1.5: 105/ 55/ 30W Max/ High/ Normal w/ Hose 32-1.0: 95/ 50/ 25W Max/ High/ Normal w/ Hose 28-1.0: 90/ 45/ 25W Max/ High/ Normal w/ Hose 28-1.5: 85/ 45/ 25W
Dimensions (L x W x H) Dimensi 体积	230x152x373mm (9"x6"x14-3/4")
Net Weight Berat Bersih 净重	3.8 - 4.5kg (8.5 - 9.9lbs.)
Continuous Usage Time (approx.) Masa Penggunaan Berterusan 连续使用时间	Normal: 140 min High: 75 min Max: 40 min with BL1860B x2

* All list price shown are for reference only (exclude SST).

* Semua harga yang ditunjukkan adalah untuk rujukan sahaja (tidak termasuk SST). 所有显示的建议零售价仅供参考 (不包括SST)。

Cordless
Tanpa Kord (Kering)

LED Flashlight
Lampu Senter LED

Vacuum Cleaner
Pembersih Vakum

Drilling / Fastening
Dreji / Pasang

Impact Drilling / Demolition
Dreji / Hancurkan

Cutting / Pressing
Potong / Tekan

Grinding / Sanding
Giling / Halus

Sawing
Gigit

Planing / Routing
Ratakan / Ratakan

Others
Lain-lain

Outdoor Power Equipment
Alat-alat Tenaga Luar





18V

LXT

Li-ion Ah 6.0 | 5.0 | 4.0 | 3.0 | 2.0 | 1.5

DVC260Z | **DVC260ZX**
RM 2,078 | RM 2,078

Cordless Backpack Vacuum Cleaner
Pembersih Vakum Beg Galas Tanpa Kord
充电式背负吸尘器



VIDEO CLIP
Models and specs may vary by country

- Max suction power 45W

Standard Equipment:

DVC260Z: HEPA Filter Assembly, Backpack Shoulder Harness, Hose Band, Paper Filter Bag (2L), Hose 28mm (1.0M), Floor Nozzle, Flexible Rubber Nozzle, Telescopic Pipe Assembly, Bent Pipe
DVC260ZX: HEPA Filter Assembly, Backpack Shoulder Harness, Hose Band, Paper Filter Bag (2L), Hose 28mm (1.5M), Front Cuffs (22, 24)

- Z / ZX: Without Charger & Battery



Capacity Kapasiti 容量	Filter bag / Paper dust bag: 2.0L Cloth dust bag: 1.5L
Max Air Flow Aliran Udara 最大空气流量	1.5m ³ /min
Max Sealed Suction Sedutan Terkedap 最大密封吸力	7.1kPa (710mmH ₂ O)
Suction Power Kuasa Sedutan 吸力	High: 45W Low: 25W
Dimensions (L x W x H) Dimensi 体积	230x152x373mm (9"x6"x14-3/4")
Net Weight Berat Bersih 净重	3.8kg (8.5 lbs)
Continuous Usage Time (approx.) Masa Penggunaan Berterusan 连续使用时间	Low: 90 min High: 60 min with BL1850B x2

DVC660Z
RM 3,118

Cordless Backpack Vacuum Cleaner
Pembersih Vakum Beg Galas Tanpa Kord
充电式背负吸尘器



- Increased suction power for improved dust collection

Standard Equipment: Floor Nozzle, Hose, Hose Band, Nozzle Assembly, Telescopic Pipe Assembly, Bent Pipe, Free Nozzle, Dust Bag

- Z: Without Charger & Battery



Capacity Kapasiti 尘袋容量	Paper Dust Bag: 6.0L Cloth Dust Bag: 5.5L
Max Air Flow Aliran Udara 最大空气流量	w/ Hose complete 32-1.0: 2.2m ³ /min w/ Hose Complete 28-1.0: 2.0m ³ /min
Max Sealed Suction Sedutan Terkedap 最大密封吸力	11kPa
Suction Power Kuasa Sedutan 吸力	Max: 90W High: 45W Normal: 25W With Hose 28-1.0
Dimensions (L x W x H) Dimensi 体积	297x174x523mm (11-3/4"x6-7/8"x20-5/8")
Net Weight Berat Bersih 净重	6.1 - 6.7kg (13.4 - 14.8lbs.)
Continuous Usage Time (approx.) Masa Penggunaan Berterusan 连续使用时间	Max: 33 min High: 62 min Normal: 116 min with BL1850B x2

DVC665Z
RM 3,773

Cordless Backpack Vacuum Cleaner
Pembersih Vakum Beg Galas Tanpa Kord
充电式背负吸尘器



- Increased suction power for improved dust collection

Standard Equipment: Hose Band, Filter Bag, Hose 28-1.5, Front Cuffs (22, 24)

- Z: Without Charger & Battery



Capacity Kapasiti 尘袋容量	Paper Dust Bag: 6.0L Cloth Dust Bag: 5.5L
Max Air Flow Aliran Udara 最大空气流量	w/ Hose Complete 28-1.5: 1.8 m ³ /min
Max Sealed Suction Sedutan Terkedap 最大密封吸力	11kPa
Suction Power Kuasa Sedutan 吸力	High: 85W Normal: 45W With Hose 28-1.5
Dimensions (L x W x H) Dimensi 体积	297x174x523mm (11-3/4"x6-7/8"x20-5/8")
Net Weight Berat Bersih 净重	6.1 - 6.7kg (13.5 - 14.9lbs.)
Continuous Usage Time (approx.) Masa Penggunaan Berterusan 连续使用时间	High: 33 min Normal: 62 min with BL1850B x2

Robotic Cleaner

Pembersih Robotik 充电式智能吸尘器

Able to clean surface area of 500m² with BL1850B x2
Boleh membersihkan kawasan permukaan Seluas 500m² dengan BL1850B x2
使用2粒BL1850B型电池的清洁500m²的面积



About 6 badminton courts



Large Capacity
Kapasiti besar 最大容量

2.5L

*Masa Penggunaan Berterusan 连续使用时间

Continuous Usage Time
with BL1850B x2 (Normal Speed)

200min
(approx.)

DRC200Z
RM 11,285

Robotic Cleaner
Pembersih Robotik
充电式智能吸尘器



- Able to clean an area of 300m² per 120 min with a coverage rate of 80%

Standard Equipment: Wireless remote controller (including two AAA alkaline batteries), Side Brush, Boundary Tape

- Z: Without Charger & Battery



VIDEO CLIP
Models and specs may vary by country

Max Cleaning Area Kawasan Pembersihan Maksimum 最大清洁面积	BL1850B x2 : 500m ²
Max Running Speed Kelajuan Operasi Maksimum 最大运行速度	0.3m/ sec
Dust Box Capacity Kapasiti 容量	2.5L
Dimensions (L x W x H) Dimensi 体积	460x460x180mm (18-1/8"x18-1/8"x7-1/8")
Net Weight Berat Bersih 净重	7.3kg (16.1lbs)
Continuous Usage Time (approx.) Masa Penggunaan Berterusan 连续使用时间	200 min with BL1850B x2

* All list price shown are for reference only (exclude SST).

* Semua harga yang ditunjukkan adalah untuk rujukan sahaja (tidak termasuk SST). 所有显示的建议零售价仅供参考 (不包括SST)。

Cordless
Power Tool
Tool Kit
LED Flashlight
Tempo Sesi, LED
COMBET
Vacuum Cleaner
Pembersih Vakum
Mesin
Drilling / Finishing
Gores / Tumpang
BOR / BUB
Impact Drilling / Demolition
Gores / Perseki
GILANG / BUBAL
Cutting / Routing
Potong / Rantai
GEB / RB
Grinding / Sanding
Gores / Pasai / Pasai
GB / GB
Sanding
Gores
GB
Planing / Routing
Perseki / Tumpang
GB / RB
Chains
Rantai
GB
Outdoor Power Equipment
Alatan Penguat
GB-CV
Makita
18V



18V

LXT

Li-ion Ah 6.0 5.0 4.0 3.0 2.0 1.5

Cordless Upright Cleaner

Pembersih Tegak Tanpa Kord 充电直立式吸尘器

High dust pick-up rate

4 rows of V-shaped bristle increase dust pick-up rate, suction power is even across the entire cleaning width due to the suction port located at the center

Sedutan tinggi

Port sedutan terletak di tengah, daya sedutan diagihkan secara merata di port penyedut bersih

高吸力

由於吸口位於中央，因此吸力平均分佈在整個清潔吸口

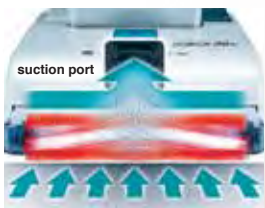

Max Sealed Suction
Sedutan Terkedap (Turus Air)
最大密封吸力(水柱)

12kPa

Two different BL motors

- One for vacuuming dust and the other for rotating brushroll
- Two motors are separately controlled according to the selected suction mode

Dua motor tanpa berus secara berasingan mengawal pengumpulan habuk dan putaran berus

两个无碳刷马达分别控制吸尘及毛刷旋转



vacuuming dust
Menyedut debu 吸尘

rotating brushroll
Berus berputar 旋转毛刷

*Masa Penggunaan Berterusan
连续使用时间

Continuous Usage Time
with BL1860B x2
(Low Noise)

120min
(approx.)



DVC560Z

RM 3,647

Cordless Upright Cleaner
Pembersih Tegak Tanpa Kord
充电直立式吸尘器



- Low noise mode allows for use in noise-sensitive environments such as office, hospital and more

Standard Equipment: Long Sash Nozzle, Round Brush, Filter Bag, Filter H (HEPA Filter)

• Z: Without Charger & Battery



Capacity Kapasiti 尘袋容量	Dust: 5L
Max Air Flow Aliran Udara 最大空气流量	1.9m³/min
Max Sealed Suction Sedutan Terkedap 最大密封吸力	12kPa
Suction Power Kuasa Sedutan 吸力	Max: 85W Normal: 50W Low Noise: 25W
Dust Pick-Up Rate Kadar Pengumpulan Debu 除尘率	Max: 47 Normal: 44 Low Noise: 40
Cleaning Width Lebar Pembersihan 清洁宽度	318mm
Brushroll Rotation Speed Kelajuan Putaran Brushroll 毛刷转速	Max: 3,500RPM Normal: 2,500RPM Low Noise: 1,000RPM
Dimensions (L x W x H) Dimensi 体积	326x318x1,146mm (12-7/8x12-1/2x45")
Net Weight Berat Bersih 净重	8.3 - 9.0kg (18.3 - 19.8lbs.)
Continuous Usage Time (approx.) Masa Penggunaan Berterusan 连续使用时间	Max: 25 min Normal: 50 min Low Noise: 100 min with BL1850B x2

DCL501Z

RM 2,528

Cordless Cyclone Cleaner
Pembersih Vakum Cyclone
Tanpa Kord
充电式旋风吸尘器

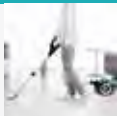

18V

- Quiet operation for operator comfort

Standard Equipment: Shoulder Belt, Crevice Nozzle, Cleaning Brush, Floor Nozzle, Zoom Pipe, Hose, Hose Hook

• Z: Without Charger & Battery



Capacity Kapasiti 容量	250mL
Max Air Flow Aliran Udara 最大空气流量	1.2m³/min
Max Sealed Suction (water column) Sedutan Terkedap (Turus Air) 最大密封吸力(水柱)	10kPa (1,020mmH ₂ O)
Suction Power Kuasa Sedutan 吸力	High: 75W Low: 25W
Dimensions (L x W x H) Dimensi 体积	352x189x252mm (13-7/8"x7-7/16"x9-7/8")
Net Weight Berat Bersih 净重	3.1kg (6.8 lbs.)
Continuous Usage Time (approx.) Masa Penggunaan Berterusan 连续使用时间	Low: 64 min High: 29 min with BL1850B

DCL500Z

RM 1,970

Cordless Cyclone Cleaner
Pembersih Vakum Cyclone
Tanpa Kord
充电式旋风吸尘器



18V

- HEPA Clean Filter offers maximum performance for residential and commercial applications

Standard Equipment: Shoulder Belt, Crevice Nozzle, Floor Nozzle, Zoom Pipe, Hose, Hose Hook

• Z: Without Charger & Battery



Capacity Kapasiti 容量	250mL
Max Air Flow Aliran Udara 最大空气流量	1.3m³/min
Max Sealed Suction (water column) Sedutan Terkedap (Turus Air) 最大密封吸力(水柱)	6.6kPa (660mmH ₂ O)
Suction Power Kuasa Sedutan 吸力	High: 75W Low: 25W
Dimensions (L x W x H) Dimensi 体积	352x189x252mm (13-7/8"x7-7/16"x9-7/8")
Net Weight Berat Bersih 净重	3.6kg (7.9 lbs.)
Continuous Usage Time (approx.) Masa Penggunaan Berterusan 连续使用时间	Low: 50 min High: 20 min with BL1850B

* All list price shown are for reference only (exclude SST).

* Semua harga yang ditunjukkan adalah untuk rujukan sahaja (tidak termasuk SST). 所有显示的建议零售价仅供参考 (不包括SST)。

Cordless
Terdapat Tanpa Kord

LED Flashlight
Lampu LED (LED)

Vacuum Cleaner
Pembersih Vakum

Drilling / Fastening
Dinding / Pasang

Impact Drilling / Demolition
Dinding / Hancurkan

Cutting / Grinding
Potong / Gosok

Trimming / Sanding
Potong / Gosok

Sawing
Gigit

Planing / Routing
Potong / Gosok

Others
Lain-lain

Outdoor Power Equipment
Alat Kuasa Luar

Makita
1915



*Compatible batteries

Cordless Cleaner

Pembersih Vakum Tanpa Kord 充电式便携吸尘器

Redesigned Floor/ Carpet T-nozzle

Muncung berbentuk T lantai / permaidani yang direka bentuk semula
重新设计的地板/地毯 T型吸嘴

- Redesigned structure reduces the resistance caused by suction, providing smooth running
Struktur yang direka bentuk semula mengurangkan rintangan yang disebabkan oleh daya sedutan dan berjalan dengan lancar
重新设计的结构减少了吸力带来的阻力，运行平稳
- Redesigned inside air flow path reduces the noise made inside the nozzle
Laluan aliran udara dalaman yang direka semula mengurangkan bunyi di dalam muncung
重新设计的内部气流路径减少了吸嘴内部的噪音



Cyclone attachment (optional)

Centrifugal force separates fine dust, allowing the main unit of the cleaner to require about 80% less frequent dust disposal

Daya sentrifugal memisahkan debu halus, mengurangkan kekerapan pembersihan penapis kira-kira 80%
离心力将细小的灰尘分开，使清洁器的主机减少了大约80%的频繁灰尘处理

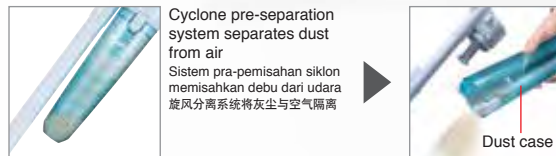

HEPA filter is available (Optional Accessories)



Suction Power
Kuasa Sedutan 吸力
Mode 4
125w

LED job light
also functions as a battery capacity warning lamp
Lampu kerja LED juga berfungsi sebagai lampu amaran kapasiti bateri
LED工作灯也可作为电池容量警告灯

Dust Capacity
Kapasiti Habuk 集尘容量
730mL

Pipe locking mechanism

Pipe is fixed with the locking mechanism to prevent it from accidentally coming off

Paip dengan mekanisme pengunci untuk mengelakkan ketagihan yang tidak disengajakan
管道通过锁定机构固定，以防止其意外脱落

*Masa Penggunaan Berterusan
连续使用时间
Continuous Usage Time
with BL4040 (Mode 1)
128min
(approx.)

CL001GA127 RM 2,188	CL001GA116 RM 2,188	CL001GZ04 RM 985	CL001GZ10 RM 985
-------------------------------	-------------------------------	----------------------------	----------------------------

Cordless Cleaner
Pembersih Vakum Tanpa Kord
充电式吸尘器



40Vmax

CL001GA116 / GZ04

CL001GA127 / GZ10

- Increased 125W suction power achieved by using 40Vmax XGT battery

Standard Equipment: Floor Nozzle, Sash Nozzle, Sash Nozzle Holder, Pipe, Easy Shake Off Filter B set

- GA127: 1x Standard Charger, 1x 2.0Ah Battery (White)
- GA116: 1x Standard Charger, 1x 2.0Ah Battery (Black)
- GZ04: Without Charger & Battery (Black)
- GZ10: Without Charger & Battery (White)



Capacity Kapasiti 容量	730mL
Max Air Flow Aliran Udara 最大空气流量	1.2m ³ /min
Max Sealed Suction (water column) Sedutan Terkedap (Turus Air) 最大密封吸力(水柱)	21kPa (2,100mmH ₂ O)
Suction Power Kuasa Sedutan 吸力	4: 125W 3: 70W 2: 45W 1: 20W with Easy Shake Off Filter
Dimensions (L x W x H) Dimensi 体积	1,066x113x152mm (42x4-7/16x6")
Net Weight Berat Bersih 净重	1.7 - 2.3 kg (3.5 - 5.1 lbs.)
Continuous Usage Time (approx.) Masa Penggunaan Berterusan 连续使用时间	4: 25 min 3: 40 min 2: 64 min 1: 128 min with BL4040

* All list price shown are for reference only (exclude SST).

* Semua harga yang ditunjukkan adalah untuk rujukan sahaja (tidak termasuk SST). 所有显示的建议零售价仅供参考 (不包括SST)。

- Cordless
Tanpa Kord (无绳)
- LED Flashlight
Lampu Sash, LED
COMBIBIT
- Vacuum Cleaner
Pembersih Vakum
吸尘器
- Drilling / Finishing
Gasing / Finishing
钻孔 / 打磨
- Impact Drilling / Demolition
Gasing / Perseki
冲击钻 / 拆除
- Cutting / Sanding
Gasing / Finishing
切割 / 打磨
- Grinding / Sanding
Gasing / Finishing
打磨 / 打磨
- Sanding
Gasing
打磨
- Planing / Routing
Perseki / Finishing
刨花 / 打磨
- Chains
Lantai
链条
- Outdoor Power Equipment
Alatan Penguasaan
户外动力设备



CAPSULE TYPE

Jenis Kapsul 胶囊型



No need to use paper bag.
This is a cost saving for repeated use
Tidak perlu menggunakan beg debu kertas,
boleh digunakan semula untuk menjimatkan kos
无需纸集尘袋, 可重复使用以节省成本

TRIGGER SWITCH

Suis Pemicu 扳机开关



Ergonomic Handle With Easy
On/ Off Trigger Switch
Pemegang ergonomik dengan suis pemicu hidup/
mati mudah 符合人体工程学的手柄, 扳机开关



Filter Penapis 过滤器
Pre Filter Penapis Depan 前置过滤器

OR



Easy shake off dust filter
High Performance Filter
Penapis prestasi tinggi 高效过滤器

OR



Easy shake off filter B set
HEPA filter Filter H set

For all LXT & CXT range
using capsule type
(18V & 12Vmax only)



DCL280

Suction Power
Kuasa Sedutan 吸力

45w

Large Capacity
Kapasiti Besar 最大容量

750mL

Net Weight
Berat Bersih 净重

1.2kg



DCL180

Suction Power
Kuasa Sedutan 吸力

30w

Large Capacity
Kapasiti Besar 最大容量

650mL

Net Weight
Berat Bersih 净重

1.2kg



CAPSULE TYPE

Jenis Kapsul 胶囊型



No need to use paper bag.
This is a cost saving for repeated use
Tidak perlu menggunakan beg debu kertas,
boleh digunakan semula untuk menjimatkan kos
无需纸集尘袋, 可重复使用以节省成本

SWITCH BUTTON

Butang Suis 开关按钮



Simply push a power on button for
continuous use
Hanya tekan butang kuasa untuk kegunaan
berterusan 一按式开关就能持续使用



Filter Penapis 过滤器
Pre Filter Penapis Depan 前置过滤器

OR



Easy shake off dust filter
High Performance Filter
Penapis prestasi tinggi 高效过滤器

OR



Easy shake off filter B set
HEPA filter Filter H set

For all LXT & CXT range
using capsule type
(18V & 12Vmax only)



CL001G

Suction Power
Kuasa Sedutan 吸力

125w

Large Capacity
Kapasiti Besar 最大容量

730mL

Net Weight
Berat Bersih 净重

1.7 kg



DCL281F

Suction Power
Kuasa Sedutan 吸力

60w

Large Capacity
Kapasiti Besar 最大容量

750mL

Net Weight
Berat Bersih 净重

1.2kg



DCL181F

Suction Power
Kuasa Sedutan 吸力

30w

Large Capacity
Kapasiti Besar 最大容量

650mL

Net Weight
Berat Bersih 净重

1.2kg



DUST BAG TYPE

Beg Debu Penapis 尘袋型



Simply by open the front cover
for easy dust bag change
Hanya dengan membuka penutup depan untuk
menukar beg habuk dengan mudah
打开前盖, 简便更换尘袋

SWITCH BUTTON

Butang Suis 开关按钮



Simply push a power on button for
continuous use
Hanya tekan butang kuasa untuk kegunaan
berterusan 一按式开关就能持续使用



Paper Filter
Penapis Kertas 纸制尘袋

OR



Dust Bag
Beg habuk 集尘袋

OR

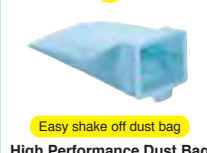

Easy shake off dust bag
High Performance Dust Bag
Beg habuk prestasi tinggi 高效集尘袋



DCL282F

Suction Power
Kuasa Sedutan 吸力

60w

Large Capacity
Kapasiti Besar 最大容量

500mL

Net Weight
Berat Bersih 净重

1.3kg



DCL182

Suction Power
Kuasa Sedutan 吸力

30w

Large Capacity
Kapasiti Besar 最大容量

500mL

Net Weight
Berat Bersih 净重

1.2kg



* All list price shown are for reference only (exclude SST).

* Semua harga yang ditunjukkan adalah untuk rujukan sahaja (tidak termasuk SST). 所有显示的建议零售价仅供参考 (不包括SST)。



12V Lithium-ion | 12V锂离子电池

CL106FD

Suction Power
Kuasa Sedutan 吸力

19_w

Large Capacity
Kapasiti Besar 最大容量

600_{mL}

Net Weight
Berat Bersih 净重

1.0_{kg}



10.8V Lithium-ion | 10.8V锂离子电池

CL100D

Suction Power
Kuasa Sedutan 吸力

14_w

Large Capacity
Kapasiti Besar 最大容量

600_{mL}

Net Weight
Berat Bersih 净重

0.88_{kg}



10.8V Lithium-ion | 10.8V锂离子电池

BUILT-IN LITHIUM-ION BATTERY

CL111D

Suction Power
Kuasa Sedutan 吸力

21_w

Large Capacity
Kapasiti Besar 最大容量

560_{mL}

Net Weight
Berat Bersih 净重

0.94_{kg}



7.2V Lithium-ion | 7.2V锂离子电池

CL070D

Suction Power
Kuasa Sedutan 吸力

14_w

Large Capacity
Kapasiti Besar 最大容量

600_{mL}

Net Weight
Berat Bersih 净重

0.81_{kg}



12V Lithium-ion | 12V锂离子电池

CL108FD

Suction Power
Kuasa Sedutan 吸力

30_w

Large Capacity
Kapasiti Besar 最大容量

600_{mL}

Net Weight
Berat Bersih 净重

1.0_{kg}



12V Lithium-ion | 12V锂离子电池

CL107FD

Suction Power
Kuasa Sedutan 吸力

32_w

Large Capacity
Kapasiti Besar 最大容量

500_{mL}

Net Weight
Berat Bersih 净重

1.1_{kg}



12V Lithium-ion | 12V锂离子电池

BUILT-IN LITHIUM-ION BATTERY

CL114FD

Suction Power
Kuasa Sedutan 吸力

35_w

Large Capacity
Kapasiti Besar 最大容量

500_{mL}

Net Weight
Berat Bersih 净重

1.1_{kg}



10.8V Lithium-ion | 10.8V锂离子电池

CL102D

Suction Power
Kuasa Sedutan 吸力

14_w

Large Capacity
Kapasiti Besar 最大容量

500_{mL}

Net Weight
Berat Bersih 净重

1.1_{kg}



10.8V Lithium-ion | 10.8V锂离子电池

BUILT-IN LITHIUM-ION BATTERY

CL104D CL105D

Suction Power
Kuasa Sedutan 吸力

20_w

Large Capacity
Kapasiti Besar 最大容量

500_{mL}

Net Weight
Berat Bersih 净重

1.1_{kg}



Cordless
无绳电钻

LED Flashlight
LED 闪光灯

Vacuum Cleaner
吸尘器

Drilling / Finishing
钻孔 / 打磨

Impact Drilling / Demolition
冲击钻孔 / 拆除

Cutting / Trimming
切割 / 修整

Grinding / Sanding
研磨 / 打磨

Sanding / Chiseling
打磨 / 凿

Planing / Routing
刨 / 铣

Chairs / Ladders
椅子 / 梯子

Outdoor Power Equipment
户外动力设备

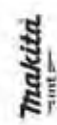

* All list price shown are for reference only (exclude SST).

* Semua harga yang ditunjukkan adalah untuk rujukan sahaja (tidak termasuk SST). 所有显示的建议零售价仅供参考 (不包括SST)。

18V

LXT

Li-ion Ah 6.0 | 5.0 | 4.0 | 3.0 | 2.0 | 1.5

Cordless Cleaner

Pembersih Vakum Tanpa Kord 充电式便携吸尘器



*Masa Penggunaan Berterusan
连续使用时间

Continuous Usage Time
with BL1830B
(Normal Speed)

50 min
(approx.)

Suction Power
 kuasa Sedutan 吸力

Max: 60W



One-touch push button switch
 Suis butang satu sentuhan
 一键式按钮开关

LED job light
 Lampu kerja LED
 LED工作灯

Dust Capacity
 Kapasiti Habuk 集尘容量

500mL

Pipe lock
 Pipe is fixed with the locking mechanism to prevent it from accidentally coming off
 Paip dengan mekanisme pengunci untuk mengelakkan ketanggalan yang tidak disengajakan
 管道通过锁定机构固定，以防止其意外脱落

DCL282FZW | DCL282FZ
 RM 840 | RM 840

Cordless Cleaner
 Pembersih Vakum Tanpa Kord
 充电式吸尘器



• Increased suction power achieved by using highly efficient BL motor

Standard Equipment: Floor Nozzle, Sash Nozzle, Sash Nozzle Holder, Pipe, Easy Shake Off Dust Bag, Paper Dust Bag, Hand Strap

• FZW: Without Charger & Battery (White)
• FZ: Without Charger & Battery (Blue)



Capacity Kapasiti 容量	Normal Dust Bag: 500mL Paper Dust Bag: 330mL
Max Air Flow Aliran Udara 最大空气流量	1.5m ³ /min
Max Sealed Suction (water column) Sedutan Terkedap (Turus Air) 最大密封吸力(水柱)	8.2kPa (820mmH ₂ O)
Suction Power kuasa Sedutan 吸力	Max: 60W High: 45W Normal: 15W with Normal Dust Bag
Dimensions (L x W x H) Dimensi 体积	1,016 x 114 x 154 mm (40 x 4-1/2 x 6-1/8")
Net Weight Berat Bersih 净重	1.3 - 1.6 kg (2.8 - 3.5 lbs.)
Continuous Usage Time (approx.) Masa Penggunaan Berterusan 连续使用时间	Normal: 50 min High: 20 min Max: 15 min with BL1830B

DCL281FZW | DCL281FZB | DCL281FZ
 RM 823 | RM 823 | RM 823

Cordless Cleaner
 Pembersih Vakum Tanpa Kord
 充电式便携吸尘器

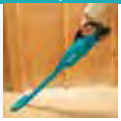

• Increased suction power achieved by using highly efficient BL motor

Standard Equipment: Floor Nozzle, Sash Nozzle, Sash Nozzle Holder, Pipe, Stay

• FZW: Without Charger & Battery (White)
• FZB: Without Charger & Battery (Black)
• FZ: Without Charger & Battery (Blue)



Capacity Kapasiti 容量	750mL
Max Air Flow Aliran Udara 最大空气流量	1.5m ³ /min
Max Sealed Suction (water column) Sedutan Terkedap (Turus Air) 最大密封吸力(水柱)	8.2kPa (820mmH ₂ O)
Suction Power kuasa Sedutan 吸力	Max: 60W High: 45W Normal: 15W with Normal Filter Max: 55W High: 40W Normal: 13W with Easy Shake Off Filter
Dimensions (L x W x H) Dimensi 体积	1,016x113x154mm (40"x4-7/16"x6-1/8")
Net Weight Berat Bersih 净重	1.2 - 1.6kg (2.7 - 3.5lbs.)
Continuous Usage Time (approx.) Masa Penggunaan Berterusan 连续使用时间	Max: 25 min High: 33 min Normal: 83 min with BL1850B

DCL280FZW | DCL280FZB | DCL280FZ
 RM 700 | RM 700 | RM 700

Cordless Cleaner
 Pembersih Vakum Tanpa Kord
 充电式便携吸尘器



• Increased suction power achieved by using highly efficient BL motor

Standard Equipment: Floor Nozzle, Sash Nozzle, Sash Nozzle Holder, Pipe, Prefilter, Filter H Set (HEPA Filter)

• FZW: Without Charger & Battery (White)
• FZB: Without Charger & Battery (Black)
• FZ: Without Charger & Battery (Blue)



Capacity Kapasiti 容量	750mL
Max Air Flow Aliran Udara 最大空气流量	1.4m ³ /min
Max Sealed Suction (water column) Sedutan Terkedap (Turus Air) 最大密封吸力(水柱)	6.4kPa (640mmH ₂ O)
Suction Power kuasa Sedutan 吸力	Normal Filter: 45W Easy Shake Off Filter: 40W
Dimensions (L x W x H) Dimensi 体积	1,016x113x154mm (40"x4-7/16"x6-1/8")
Net Weight Berat Bersih 净重	1.2 - 1.6kg (2.7 - 3.5lbs.)
Continuous Usage Time (approx.) Masa Penggunaan Berterusan 连续使用时间	33 min with BL1850B

* All list price shown are for reference only (exclude SST).

* Semua harga yang ditunjukkan adalah untuk rujukan sahaja (tidak termasuk SST). 所有显示的建议零售价仅供参考 (不包括SST)。

Cordless
LED Flashlight
Vacuum Cleaner
Drilling / Fastening
Impact Drilling / Demolition
Cutting / Pressing
Grinding / Sanding
Sawing
Planing / Routing
Others
Outdoor Power Equipment





Li-ion Ah 6.0 5.0 4.0 3.0 2.0 1.5

DCL181FZWX

RM 632

Cordless Cleaner

Pembersih Vakum Tanpa Kord
充电式便携吸尘器

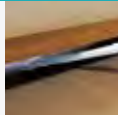

- Strong suction power for fast cleaning with more run time

Standard Equipment: Floor Nozzle, Sash Nozzle, Sash Nozzle Holder, Pipe, Filter, Prefilter, Stay

- FZWX: Without Charger & Battery (White)



Capacity Kapasiti 容量	650mL
Max Air Flow Aliran Udara 最大空气流量	1.4m³/min
Max Sealed Suction (water column) Sedutan Terkeday (Turus Air) 最大密封吸力(水柱)	5.3kPa (540mmH ₂ O)
Suction Power Kuasa Sedutan 吸力	High: 30W Low: 11W
Dimensions (L x W x H) Dimensi 体积	999x114x152mm (39-1/4"x4-1/2"x6")
Net Weight Berat Bersih 净重	1.2 - 1.4kg (2.7 - 3.1lbs.)
Continuous Usage Time (approx.) Masa Penggunaan Berterusan 连续使用时间	Low: 66 min High: 33 min with BL1850B

DCL180FRFW

RM 1,143

DCL180RFB

RM 1,143

DCL180ZB

RM 487

DCL180Z

RM 487

Cordless Cleaner

Pembersih Vakum Tanpa Kord
充电式便携吸尘器

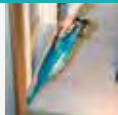

DCL180FRFW



- Strong suction power for fast cleaning

Standard Equipment:

FRFW: Floor Nozzle, Sash Nozzle, Sash Nozzle Holder, Pipe, Stay, Easy Shake Off Filter.
RFB / ZB / Z: Floor Nozzle, Sash Nozzle, Sash Nozzle Holder, Pipe, Stay, Filter, Prefilter

- FRFW: 1x Rapid Charger, 1x 3.0Ah Battery (White)
- RFB: 1x Rapid Charger, 1x 3.0Ah Battery (Black)
- ZB: Without Charger & Battery (Black)
- Z: Without Charger & Battery (Blue)

Only for DCL180FRFW



DCL180

VIDEO CLIP

Models and specs may vary by country

Capacity Kapasiti 容量	650mL
Max Air Flow Aliran Udara 最大空气流量	1.4m³/min
Max Sealed Suction (water column) Sedutan Terkeday (Turus Air) 最大密封吸力(水柱)	4.2kPa (428mmH ₂ O)
Suction Power Kuasa Sedutan 吸力	30W
Dimensions (L x W x H) Dimensi 体积	999x114x152mm (39-1/4"x4-1/2"x6")
Net Weight Berat Bersih 净重	1.2kg (2.7 lbs)
Continuous Usage Time (approx.) Masa Penggunaan Berterusan 连续使用时间	33 min with BL1850B

DCL182FRFW

RM 1,305

DCL182FZW

RM 648

Cordless Cleaner

Pembersih Vakum Tanpa Kord
充电式便携吸尘器



- Improved front cover opens with push button for easier access

Standard Equipment: Floor Nozzle, Sash Nozzle, Sash Nozzle Holder, Pipe, Dust Bag, Paper Dust Bag Sps

- FRFW: 1x Rapid Charger, 1x 3.0Ah Battery (White)
- FZW: Without Charger & Battery (White)

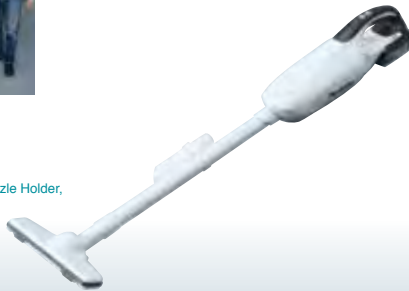

Capacity Kapasiti 容量	Dust Bag: 500mL Paper Pack: 330mL
Max Air Flow Aliran Udara 最大空气流量	1.4m³/min
Max Sealed Suction (water column) Sedutan Terkeday (Turus Air) 最大密封吸力(水柱)	5.4kPa (551mmH ₂ O)
Suction Power Kuasa Sedutan 吸力	High: 30W Low: 11W
Dimensions (L x W x H) Dimensi 体积	1,004x115x151mm (39-1/2"x4-1/2"x5-15/16")
Net Weight Berat Bersih 净重	1.3kg (2.8 lbs)
Continuous Usage Time (approx.) Masa Penggunaan Berterusan 连续使用时间	Low: 66 min High: 33 min with BL1850B

DVC750LZ

RM 1,507

DVC750LZX1

RM 1,532

Cordless Portable Vacuum Cleaner

Pembersih Vakum Tanpa Kord
充电式轻便吸尘器



- Two tools in one; quickly converts from vacuum to blower for increased versatility

Standard Equipment: Hose, Wide Nozzle, Sash Nozzle

- LZ: Without Charger & Battery
- LZX1: 1x Shoulder Belt, Without Charger & Battery



DVC750

VIDEO CLIP

Models and specs may vary by country



Capacity Kapasiti 容量	Dust: 7.5L
Max Air Flow Aliran Udara 最大空气流量	High: 1.6m³/min Normal: 1.3m³/min
Max Sealed Suction Sedutan Terkeday (Turus Air) 最大密封吸力(水柱)	High: 6.7kPa Normal: 4.2kPa
Suction Power Kuasa Sedutan 吸力	High: 50W Normal: 25W
Dimensions (L x W x H) Dimensi 体积	418x251x278mm (16-1/2"x9-7/8"x11")
Net Weight Berat Bersih 净重	4.3 - 4.6kg (9.4 - 10.1 lbs.)
Continuous Usage Time (approx.) Masa Penggunaan Berterusan 连续使用时间	Normal: 60 min High: 30 min with BL1850B

DVC350Z

RM 1,808

Cordless Vacuum Cleaner

Pembersih Vakum Tanpa Kord
充电式吸尘器



- Large 3L dust bag capacity

Standard Equipment: Nozzle assembly, Dust Bag Assembly, Hose, Shoulder Belt

- Z: Without Charger & Battery



Max Peak Air Flow Aliran Udara 最大空气流量	3.4m³/min
Max Sealed Suction (water column) Sedutan Terkeday (Turus Air) 最大密封吸力(水柱)	5.5kPa (560mmH ₂ O)
Recoverable Capacity Kapasiti 容量	Dust: 3L
Dimensions (L x W x H) Dimensi 体积	273x195x226mm (10-3/4"x7-5/8"x8-7/8")
Net Weight Berat Bersih 净重	2.2kg (4.8lbs)
Continuous Usage Time (approx.) Masa Penggunaan Berterusan 连续使用时间	Low: 43 min High: 22 min with BL1850B



DVC350/DVC260

VIDEO CLIP

Models and specs may vary by country

* All list price shown are for reference only (exclude SST).

* Semua harga yang ditunjukkan adalah untuk rujukan sahaja (tidak termasuk SST). 所有显示的建议零售价仅供参考 (不包括SST)。

Cordless
Tanpa Kord (无绳)

LED Flashlight
Lampu Sash, LED
COMBILT

Vacuum Cleaner
Pembersih Vakum

Drilling / Finishing
Gores / Tugasan
BOR / HIR

Impact Drilling / Demolition
Gores / Hancurkan
GILANG / HIRANG

Cutting / Finishing
Potong / Finishing
UKIR / HIR

Grinding / Sanding
Gores / Gores
GIRI / HIR

Sanding
Gores
GIRI

Planing / Routing
Perataan / Tugasan
RATA / HIR

Onsite
Lokasi
SITU

Outdoor Power Equipment
Alatan Penguasaan
LUAR-DALAM

Makita
TUMBUH



Cordless
Tanpa Kord (Kordless)

LED Flashlight
Lampu Sorot LED (LED Lamp)

Vacuum Cleaner
Pembersih Vakum (Vacuum Cleaner)

Drilling / Fastening
Droplu / Pasang (Drill / Fasten)

Impact Drilling / Demolition
Droplu / Pasang (Impact Drill / Demolition)

Cutting / Pushing
Potong / Dorong (Cut / Push)

Grinding / Sanding
Mergul / Halus (Grind / Sand)

Sawing
Gigit (Saw)

Planing / Routing
Droplu / Pasang (Plan / Route)

Others
Lain-lain (Others)

Outdoor Power Equipment
Alat-alat Tenaga Luar (Outdoor Power Equipment)



DCL184Z

RM 965

Cordless Cleaner
Pembersih Vakum Tanpa Kord
充电式吸尘器



18V

NEW BARU 新

- Higher suction power and longer continuous run time

Standard Equipment:
Seat Nozzle, Mat Nozzle, Rubber Nozzle, Soft Brush, Blower Attachment, Dust Bag, Paper Dust Bag 5pcs (194566-1), Shoulder Belt

- Z: Without Charger & Battery



DCL184



VIDEO CLIP
Models and specs may vary by country



Capacity Kapasiti 容量	Cloth Dust Bag: 500mL Paper Dust Bag: 330mL
Max Air Flow Aliran Udara 最大空气流量	1.4m ³ /min
Max Sealed Suction (water column) Sedutan Terkedap (Turus Air) 最大密封吸力(水柱)	5.4kPa (550mmH ₂ O)
Suction Power Kuasa Sedutan 吸力	Max: 38W High: 23W Normal: 5W
Dimensions (L x W x H) Dimensi 体积	365x138x202mm (14-3/8x5-7/16x8")
Net Weight Berat Bersih 淨重	1.8 - 2.2kg (4.0 - 4.9lbs.)
Continuous Usage Time (approx.) Masa Penggunaan Berterusan 连续使用时间	Max: 33 min High: 50 min Normal: 133 min with BL1850B

CL121DZ

RM 965

Cordless Cleaner
Pembersih Vakum Tanpa Kord
充电式吸尘器



12Vmax

- Comes with a variety of special nozzles optimum for cleaning car interior

Standard Equipment:
Mat Nozzle, Seat Nozzle, Rubber Nozzle, Soft Brush, Blower Nozzle, Dust Bag, Paper Dust Bag 5pcs (194566-1), Shoulder Belt

- DZ: Without Charger & Battery



CL121D



VIDEO CLIP
Models and specs may vary by country



Capacity Kapasiti 容量	Dust Bag: 500mL Paper Pack: 330mL
Max Air Flow Aliran Udara 最大空气流量	1.3m ³ /min
Max Sealed Suction (water column) Sedutan Terkedap (Turus Air) 最大密封吸力(水柱)	4.6kPa (470 mmH ₂ O)
Suction Power Kuasa Sedutan 吸力	Max: 28W High: 19W Normal: 5W
Dimensions (L x W x H) Dimensi 体积	345x138x202mm (13-5/8"x5-7/16"x8")
Net Weight Berat Bersih 淨重	1.7 - 1.8kg (3.7 - 4.0lbs.)
Continuous Usage Time (approx.) Masa Penggunaan Berterusan 连续使用时间	Normal: 33 min High: 16 min Max: 13 min with BL1021B

CL108FDWYW | CL108FDZW

RM 937 | RM 582

Cordless Cleaner
Pembersih Vakum Tanpa Kord
充电式便携吸尘器



12Vmax

- Compact and High Suction Power

Standard Equipment:
Floor Nozzle, Sash Nozzle, Sash Nozzle Holder, Pipe, Filter, Prefilter

- FDWYW: 1x Standard Charger, 1x 1.5Ah Battery (White)
- FDZW: Without Charger & Battery (White)



CL108FD



VIDEO CLIP
Models and specs may vary by country



Capacity Kapasiti 容量	600mL
Max Air Flow Aliran Udara 最大空气流量	1.2m ³ /min
Max Sealed Suction (water column) Sedutan Terkedap (Turus Air) 最大密封吸力(水柱)	4.4kPa (445mmH ₂ O)
Suction Power Kuasa Sedutan 吸力	Max: 30W High: 20W Normal: 5W
Dimensions (L x W x H) Dimensi 体积	956x110x150mm (37-5/8"x4-5/16"x5-7/8")
Net Weight Berat Bersih 淨重	1.0 - 1.2kg (2.3 - 2.7lbs.)
Continuous Usage Time (approx.) Masa Penggunaan Berterusan 连续使用时间	Normal: 33 min High: 16 min Max: 13 min with BL1021B

CL106FDWYW | CL106FDZW

RM 820 | RM 465

Cordless Cleaner
Pembersih Vakum Tanpa Kord
充电式便携吸尘器



12Vmax

- Stronger suction power for faster cleaning with more run time

Standard Equipment:
Floor Nozzle, Sash Nozzle, Sash Nozzle Holder, Pipe, Filter, Prefilter

- FDWYW: 1x Standard Charger, 1x 1.5Ah Battery (White)
- FDZW: Without Charger & Battery (White)



CL106FD



VIDEO CLIP
Models and specs may vary by country



Capacity Kapasiti 容量	600mL
Max Air Flow Aliran Udara 最大空气流量	1.3m ³ /min
Max Sealed Suction (water column) Sedutan Terkedap (Turus Air) 最大密封吸力(水柱)	3.1kPa (316mmH ₂ O)
Suction Power Kuasa Sedutan 吸力	19W
Dimensions (L x W x H) Dimensi 体积	958x100x150mm (37-3/4"x3-15/16"x5-7/8")
Net Weight Berat Bersih 淨重	1.0kg (2.2 lbs.)
Continuous Usage Time (approx.) Masa Penggunaan Berterusan 连续使用时间	21 min with BL1021B

CL107FDWYW | CL107FDZW

RM 982 | RM 628

Cordless Cleaner
Pembersih Vakum Tanpa Kord
充电式便携吸尘器



12Vmax

- 3 mode suction power settings

Standard Equipment:
Floor Nozzle, Sash Nozzle, Sash Nozzle Holder, Pipe, Dust Bag, Paper Dust Bag 5pcs (194566-1)

- FDWYW: 1x Standard Charger, 1x 1.5Ah Battery (White)
- FDZW: Without Charger & Battery (White)



CL107FD



VIDEO CLIP
Models and specs may vary by country



Capacity Kapasiti 容量	Dust Bag: 500mL Paper Pack: 330mL
Max Air Flow Aliran Udara 最大空气流量	1.4m ³ /min
Max Sealed Suction (water column) Sedutan Terkedap (Turus Air) 最大密封吸力(水柱)	5.0kPa (510mmH ₂ O)
Suction Power Kuasa Sedutan 吸力	Max: 32W High: 20W Normal: 5W
Dimensions (L x W x H) Dimensi 体积	960x112x150mm (37-3/4"x4-3/8"x5-7/8")
Net Weight Berat Bersih 淨重	1.1kg (2.5lbs.)
Continuous Usage Time (approx.) Masa Penggunaan Berterusan 连续使用时间	Normal: 25 min High: 12 min Max: 10 min with BL1021B

* All list price shown are for reference only (exclude SST).

* Semua harga yang ditunjukkan adalah untuk rujukan sahaja (tidak termasuk SST). 所有显示的建议零售价仅供参考 (不包括SST)。

12V_{max}

CXT

10.8V

Li-ion Ah 2.0 1.3

CL114FDWI
RM 648

Cordless Cleaner
Pembersih Vakum Tanpa Kord
充电式便携吸尘器



12V_{max}

With Built-in Battery
Dengan Bateri Terbina Dalam
内置电池



- Much higher 35W suction power due to 2.0Ah battery

Standard Equipment: Floor Nozzle, Sash Nozzle, Sash Nozzle Holder, Pipe, Dust Bag, Paper Dust Bag 5pcs (194566-1)

- DWI: 1x Standard Charger, Built-in 2.0Ah Battery (White)



Capacity Kapasiti 容量	Cloth Dust Bag: 500mL Paper Dust Bag: 330mL
Max Air Flow Aliran Udara 最大空气流量	1.4m ³ /min
Max Sealed Suction (water column) Sedutan Terkedap (Turus Air) 最大密封吸力(水柱)	5.0kPa (510mmH ₂ O)
Suction Power Kuasa Sedutan 吸力	Powerful: 35W High: 20W Low: 5W
Dimensions (L x W x H) Dimensi 体积	983x113x136mm (38-3/4x4-7/16x5-3/8")
Net Weight Berat Bersih 净重	1.1kg (2.4lbs)
Continuous Usage Time (approx.) Masa Penggunaan Berterusan 连续使用时间	Normal: 55 min High: 18 min Powerful: 10 min with Built-in Lithium-ion Battery

CL100DW | CL100DZ
RM 623 | RM 278

Cordless Cleaner
Pembersih Vakum Tanpa Kord
充电式便携吸尘器

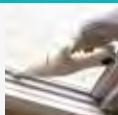

10.8V



- Increased storage capacity for longer time between waste disposal

Standard Equipment: Floor Nozzle, Sash Nozzle, Sash Nozzle Holder, Pipe, Filter, Prefilter

- DW: 1x Standard Charger, 1x 1.3Ah Battery (White)
- DZ: Without Charger & Battery (White)

Capacity Kapasiti 容量	600mL
Max Air Flow Aliran Udara 最大空气流量	1.3m ³ /min
Max Sealed Suction (water column) Sedutan Terkedap (Turus Air) 最大密封吸力(水柱)	2.3kPa (235mmH ₂ O)
Suction Power Kuasa Sedutan 吸力	14W
Dimensions (L x W x H) Dimensi 体积	966x103x150mm (38-1/32"x4-1/16"x5-7/8")
Net Weight Berat Bersih 净重	0.88kg (1.94lbs)
Continuous Usage Time (approx.) Masa Penggunaan Berterusan 连续使用时间	12 min with BL1013

CL102DW | CL102DZ
RM 752 | RM 428

Cordless Cleaner
Pembersih Vakum Tanpa Kord
充电式便携吸尘器



10.8V



- Quick clean-ups with strong suction power

Standard Equipment: Floor Nozzle, Sash Nozzle, Sash Nozzle Holder, Pipe, Dust Bag, Paper Dust Bag 5pcs

- DW: 1x Standard Charger, 1x 1.3Ah Battery (White)
- DZ: Without Charger & Battery (White)



Capacity Kapasiti 容量	Dust Bag: 500mL Paper Pack: 330mL
Max Air Flow Aliran Udara 最大空气流量	1.1m ³ /min
Max Sealed Suction (water column) Sedutan Terkedap (Turus Air) 最大密封吸力(水柱)	2.7kPa (275mmH ₂ O)
Suction Power Kuasa Sedutan 吸力	High: 14W Low: 6W
Dimensions (L x W x H) Dimensi 体积	984x113x150mm (38-3/4"x4-7/16"x5-7/8")
Net Weight Berat Bersih 净重	1.1kg (2.4lbs)
Continuous Usage Time (approx.) Masa Penggunaan Berterusan 连续使用时间	Low: 21 min High: 13 min with BL1013

CL111DWI | CL111DWR
RM 895 | RM 895

Cordless Cleaner
Pembersih Vakum Tanpa Kord
充电式便携吸尘器



10.8V

With Built-in Battery
Dengan Bateri Terbina Dalam
内置电池



- LED light indicates when to charge battery

Standard Equipment: Nozzle for Flooring & Carpet, Sash Nozzle, Sash Nozzle Holder, Pipe, Adapter

- DWI (Ivory): 1x Standard Charger, Built-in 1.5Ah Battery, Dust Bag, Paper Dust Bag 5pcs
- DWR (Red): 1x Standard Charger, Built-in 1.5Ah Battery, Filter, Prefilter

Capacity Kapasiti 容量	560mL
Max Air Flow Aliran Udara 最大空气流量	1.4m ³ /min
Max Sealed Suction (water column) Sedutan Terkedap (Turus Air) 最大密封吸力(水柱)	3.4kPa (350mmH ₂ O)
Suction Power Kuasa Sedutan 吸力	21W
Dimensions (L x W x H) Dimensi 体积	906x102x109mm (35-3/4"x4"x4-1/4")
Net Weight Berat Bersih 净重	0.94kg (2.1lbs.)
Continuous Usage Time (approx.) Masa Penggunaan Berterusan 连续使用时间	12 min with Built-in Lithium-ion Battery

CL104DWYX | CL104DWY
RM 590 | RM 590

Cordless Cleaner
Pembersih Vakum Tanpa Kord
充电式便携吸尘器

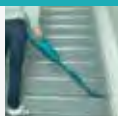

10.8V

With Built-in Battery
Dengan Bateri Terbina Dalam
内置电池



- Increased storage capacity for longer time between waste disposal

Standard Equipment: Floor Nozzle, Sash Nozzle, Sash Nozzle Holder, Pipe, Dust Bag, Adapter (DC1001), Paper Dust Bag 5pcs (194566-1)

- DWYX: 1x Standard Charger, Built-in 1.5Ah Battery (Blue)
- DWY: 1x Standard Charger, Built-in 1.5Ah Battery (White)



Capacity Kapasiti 容量	Dust Bag: 500mL Paper Pack: 330mL
Max Air Flow Aliran Udara 最大空气流量	1.1m ³ /min
Max Sealed Suction (water column) Sedutan Terkedap (Turus Air) 最大密封吸力(水柱)	3.3kPa (340mmH ₂ O)
Suction Power Kuasa Sedutan 吸力	Turbo: 20W High: 14W Low: 5W
Dimensions (L x W x H) Dimensi 体积	983x113x136mm (38-3/4"x4-7/16"x5-3/8")
Net Weight Berat Bersih 净重	1.1kg (2.3lbs)
Continuous Usage Time (approx.) Masa Penggunaan Berterusan 连续使用时间	Low: 30 min High: 15 min Turbo: 10 min with Built-in Lithium-ion Battery

* All list price shown are for reference only (exclude SST).

* Semua harga yang ditunjukkan adalah untuk rujukan sahaja (tidak termasuk SST). 所有显示的建议零售价仅供参考 (不包括SST)。

Cordless
Power Tool
无绳
电动工具

LED Flashlight
手提式LED
手电筒
LED手電筒

Vacuum Cleaner
吸尘器
吸塵器

Drilling / Finishing
鑽孔 / 打磨
鑽孔 / 打磨

Impact Drilling / Demolition
衝擊鑽孔 / 拆除
衝擊鑽孔 / 拆除

Cutting / Routing
切割 / 銑削
切割 / 銑削

Grinding / Sanding
磨削 / 打磨
磨削 / 打磨

Sanding
打磨
打磨

Planing / Routing
刨削 / 銑削
刨削 / 銑削

Other
其他
其他

Outdoor Power Equipment
戶外動力設備
戶外動力設備

Makita
Makita

18V

LXT

10.8V

7.2V

Li-ion Ah 1.5 1.3

CL105DW | CL105DWX
RM 570 | RM 570

Cordless Cleaner
Pembersih Vakum Tanpa Kord
充电式便携吸尘器

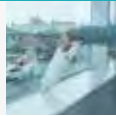

10.8V With Built-in Battery
Dengan Bateri Terbina Dalam
内置電池

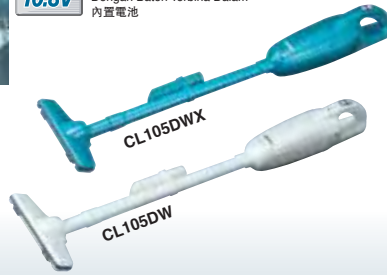

• Strong suction power of 20W

Standard Equipment: Floor Nozzle, Sash Nozzle, Sash Nozzle Holder, Pipe, Dust Bag, Adapter (DC1001), Paper Dust Bag 5pcs (194566-1)

• DW: 1x Standard Charger, Built-in 1.3Ah Battery (White)
• DWX: 1x Standard Charger, Built-in 1.3Ah Battery (Blue)



Capacity Kapasiti 容量	Dust Bag: 500mL Paper Pack: 330mL
Max Air Flow Aliran Udara 最大空气流量	1.1m³/min
Max Sealed Suction (water column) Sedutan Terkedap (Turus Air) 最大密封吸力(水柱)	3.3kPa (340mmH ₂ O)
Suction Power Kuasa Sedutan 吸力	Turbo: 20W High: 14W Low: 5W
Dimensions (L x W x H) Dimensi 体积	983x113x136mm (38-3/4"x4-7/16"x5-3/8")
Net Weight Berat Bersih 淨重	1.1kg (2.3lbs)
Continuous Usage Time (approx.) Masa Penggunaan Berterusan 连续使用时间	Low: 20 min High: 10 min Turbo: 7 min with Built-in Lithium-ion Battery

CL070DZ
RM 263

Cordless Cleaner
Pembersih Vakum Tanpa Kord
充电式便携吸尘器



7.2V



• Increased storage capacity for longer time between waste disposal

Standard Equipment: Floor Nozzle, Sash Nozzle, Sash Nozzle Holder, Pipe, Filter, Prefilter

• DZ: Without Charger & Battery (White)

Capacity Kapasiti 容量	600mL
Max Air Flow Aliran Udara 最大空气流量	1.2m³/min
Max Sealed Suction (water column) Sedutan Terkedap (Turus Air) 最大密封吸力(水柱)	1.8kPa (180mmH ₂ O)
Suction Power Kuasa Sedutan 吸力	14W
Dimensions (L x W x H) Dimensi 体积	966x103x142mm (38-1/32"x4-1/16"x5-5/8")
Net Weight Berat Bersih 淨重	0.81kg (1.8lbs)
Continuous Usage Time (approx.) Masa Penggunaan Berterusan 连续使用时间	8 min with BL7010

CL183DZX
RM 272

Cordless Cleaner
Pembersih Vakum Tanpa Kord
充电式便携吸尘器



18V
G-Battery



• Compact and lightweight design

Standard Equipment: Floor Nozzle, Sash Nozzle, Sash Nozzle Holder, Pipe, Filter, Prefilter

• DZX: Without Charger & Battery

Capacity Kapasiti 容量	600mL
Max Air Flow Aliran Udara 最大空气流量	1.3m³/min
Max Sealed Suction (water column) Sedutan Terkedap (Turus Air) 最大密封吸力(水柱)	2.6kPa (270mmH ₂ O)
Suction Power Kuasa Sedutan 吸力	17W
Dimensions (L x W x H) Dimensi 体积	966x102x148mm (38"x4"x5-7/8")
Net Weight Berat Bersih 淨重	1.2kg (2.6lbs.)
Continuous Usage Time (approx.) Masa Penggunaan Berterusan 连续使用时间	30 min with BL1815G

Model	Dust Class	Powered	Tank Capacity		Tank Type	Max Air Flow (m³/min)	Max Sealed Suction (kPa)	BL MOTOR	XPT	AWS
			Dust	Water						
DVC560	(HEPA filter)	18Vx2	5L	-	-	1.9	12	●	-	-
DVC665	(HEPA filter)	18Vx2	Paper Dust Bag 6.0L Cloth Dust Bag 5.5L	-	-	1.8****	11	●	-	●
DVC660	(HEPA filter)	18Vx2	Paper Dust Bag 6.0L Cloth Dust Bag 5.5L	-	-	2.2***** 2.0***	11	●	-	-
DVC867L	L (HEPA filter)	18Vx2	8L	-	Plastic	2.1	11	●	●	●
DVC865L	L	18Vx2	8L	6L	Plastic	2.1	11	●	●	-
DVC864L	L (HEPA filter)	18Vx2	8L	-	Plastic	2.1	9.8	●	●	●
DVC863L	L (HEPA filter)	18Vx2	8L	-	Plastic	2.1	9.8	●	●	-
DVC862L	L	18Vx2	8L	6L	Plastic	2.1	9.8	●	●	-
DVC860L	L	18Vx2 AC	8L	6L	Plastic	DC: 2.1** AC: 3.6**	DC: 9.0 AC: 24	-	-	-
DVC157L	L (HEPA filter)	18Vx2	15L	-	Plastic	2.1	11	●	●	●
DVC155L	L	18Vx2	15L	12L	Plastic	2.1	11	●	●	-
DVC154L	L (HEPA filter)	18Vx2	15L	-	Plastic	2.1	9.8	●	●	●
DVC153L	L (HEPA filter)	18Vx2	15L	-	Plastic	2.1	9.8	●	●	-
DVC152L	L	18Vx2	15L	12L	Plastic	2.1	9.8	●	●	-
DVC151L	L (HEPA filter)	18Vx2 AC	15L	-	Plastic	DC: 2.1** AC: 3.6**	DC: 9.0 AC: 24	-	-	-
DVC150L	L	18Vx2 AC	15L	12L	Plastic	DC: 2.1** AC: 3.6**	DC: 9.0 AC: 24	-	-	-
DVC265	(HEPA filter)	18Vx2	Paper Dust Bag 2.0L Cloth Dust Bag 1.5L	-	-	2.0*** 1.8****	11	●	-	●
DVC261	(HEPA filter)	18Vx2	Paper Dust Bag 2.0L Cloth Dust Bag 1.5L	-	-	1.5*	11	●	-	-
DVC260	(HEPA filter)	18Vx2	Paper Dust Bag 2.0L Cloth Dust Bag 1.5L	-	-	1.5*	7.1	●	-	-
DVC750L	L (HEPA filter)	18V	7.5L	4.5L	Plastic	1.6	6.7	●	●	-
DVC350	-	18V	3.0L	-	-	3.4*	5.5	-	-	-

*With hose Ø 28-2.5 **With hose Ø 38-2.5 ***With hose Ø 28-1.0 ****With hose Ø 28-1.5 *****With hose Ø 32-1.0

* All list price shown are for reference only (exclude SST).

* Semua harga yang ditunjukkan adalah untuk rujukan sahaja (tidak termasuk SST). 所有显示的建议零售价仅供参考 (不包括SST)。

Cordless
Tanda Kord Tanpa Kord

LED Flashlight
Lampu Senter LED
LED 1000LM

Vacuum Cleaner
Pembersih Vakum

Drilling / Fastening
Dinding / Pasang
BOR / PASANG

Impact Drilling / Demolition
Dinding / Pasang
BOR / PASANG

Cutting / Pushing
Gigit / Dorong
GIGIT / DORONG

Grinding / Sanding
Mergul / Hais
MERGUL / HAIS

Sanding / Planing
Mergul / Hais
MERGUL / HAIS

Others
Lain-lain
LAIN-LAIN

Outdoor Power Equipment
Alat Kuasa Luar
ALAT KUASA LUAR

Makita
MAKITA

Centrifugal force separates fine dust, allowing the main unit of the cleaner to require about 80% less frequent dust disposal

Daya sentrifugal memisahkan debu halus, mengurangkan kekerapan pembersihan penapis kira-kira 80%
 离心力将细小的灰尘分开，使清洁器的主机减少了大约80%的频繁灰尘处理



Cyclone pre-separation system separates dust from air

Sistem pra-pemisahan siklon memisahkan debu dari udara
 旋风分离系统将灰尘与空气隔离



Dust case

Easy disposal of the fine dust collected in dust case

Debu halus dikumpulkan dalam pengumpul habuk mudah dibersihkan
 集尘箱中收集的细粉尘方便处理



The main unit of the cleaner requires much less frequent dust disposal

Mangurangkan kekerapan pembersihan pengumpul habuk
 减少清空集尘箱频率

Cyclone Attachment Set

Set Pengumpul Habuk Siklon 旋风集尘配件

Pipe lock

DCL280F, DCL281F, DCL282F

Part No.191D71-3 (White)
 Part No.191D73-9 (Black)



Dust capacity **400mL** / Net weight **0.36kg**

CL106FD, CL107FD, CL108FD, DCL180, DCL181F, DCL182, CL183D

Part No.199491-1 (White)
 Part No.191D75-5 (Black)



Dust capacity **400mL** / Net weight **0.35kg**

Easily fitting

Mudah dipasang 轻松拟合



With short pipe (Part No.191D76-3)



With short pipe (Part No.191D79-7)

Without standard pipe (Part No.451241-5)



By using this short pipe when attaching Cyclone attachment, you can use the cleaner with the same overall length as the cleaner without Cyclone attachment

Dengan menggunakan paip pendek ini apabila bersambung dengan set pengumpul habuk siklon, anda boleh menggunakan pembersih dengan panjang keseluruhan yang sama seperti pembersih tanpa set pengumpul habuk siklon
 安装旋风集尘配件时使用此短管，可以使吸尘机的总长度与不安装旋风集尘配件的吸尘器相同

Pipe lock DCL280F, DCL281F, DCL282F

Pipe is fixed with the locking mechanism to prevent it from accidentally coming off

Paip dengan mekanisme penguncian untuk mengelakkannya dari jatuh tanpa sengaja 管锁固定以防止意外脱落



Pipe with beveled end

Cleaning of tight places can be done without nozzle by using the beveled end of pipe as a nozzle

Paip serong bertindak sebagai muncung untuk membersihkan kawasan sempit
 倒角管的倾斜端作为喷嘴可以清洁狭窄的地方



Suction Power Keep

90%*



*When used with DCL182 (wood dust)

Cordless
 Tanpa Kabel / 无线
 LED Flashlight
 Lampu Suka / LED
 LIGHT
 Vacuum Cleaner
 Tembakul / Vacuum
 吸尘器
 Drilling / Finishing
 Bor / Finishing
 钻孔 / 打磨
 Impact Drilling / Demolition
 Bor / Perseki /
 冲击钻孔 / 拆除
 Cutting / Sanding
 Potong / Gores
 切割 / 打磨
 Grinding / Sanding
 Menggosok / Gores
 磨光 / 打磨
 Sawing
 Gergaji
 锯
 Planning / Routing
 Perataan / Trogam
 刨平 / 开槽
 Chisels
 Paksi
 凿子
 Outdoor Power Equipment
 Alatan Kuasa Luar
 户外动力设备
Makita
 THE BLUE LINE

Cordless
Durable Acid Resistant

LED Flashlight
Lampy SAMA LED
LED 0.9/0.9/0.9

Vacuum Cleaner
Pervelikan Vacuum
3.5/3.5/3.5

Drilling / Fastening
Droptail / Pasang
10.0 / 10.0

Impact Drilling / Demolition
Droptail / Pasang
15.0/15.0 / 15.0/15.0

Cutting
Proteksi
0.0/0.0

Grinding / Sanding
Pengkilan / Pasang
20.0 / 20.0

Sawing
Memotong
0.0/0.0

Planing / Routing
Pengkilan / Pasang
10.0 / 10.0

Others
Lain-lain
10.0

Outdoor Power Equipment
Alat-alat Listrik
10.0 / 10.0

Makita
1915

For Cleaning



Model
DVC350 / DVC860L /
DVC862L / DVC863L



Model
DVC261 / DVC265

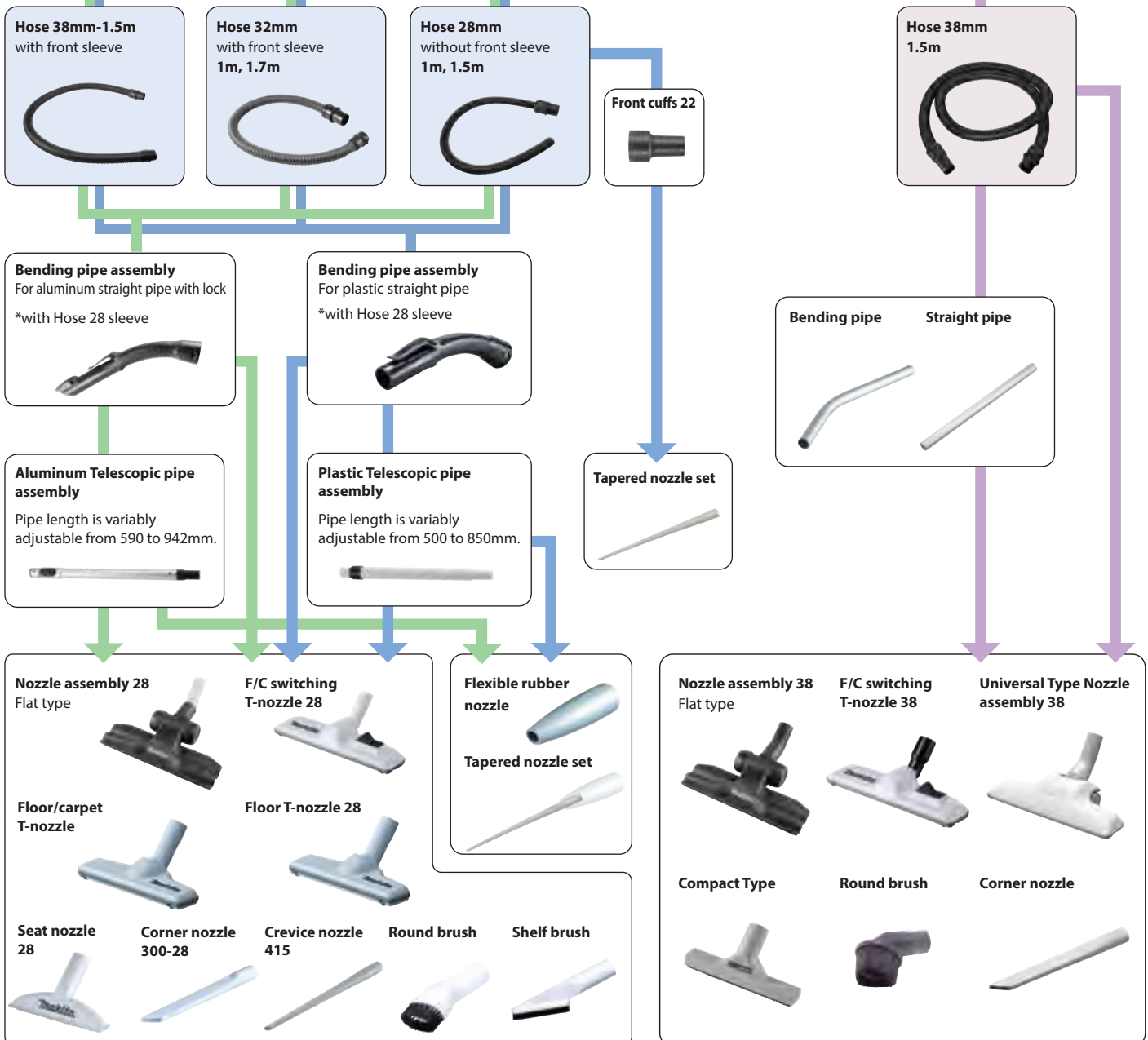

Cordless Cleaner System charts

Model
Makita all Cordless Cleaners

28-J Straight pipe

28-K Flexible hose

28-Q Flexible rubber nozzle

28-M Round brush

28-O Sash nozzle

28-L Nozzle assembly

28-N Corner nozzle

28-P Shelf brush

For Cordless Cleaner 28-J Straight pipe



Description	Color	Part No.
Aluminum Telescopic pipe assembly Pipe length is variably adjustable from 590 to 942mm.	Aluminum	140G19-0
Telescopic pipe assembly 28 Pipe length is variably adjustable from 500 to 850mm.	White	198560-5
	Ivory	451424-7
	White	451241-5
	Blue	451244-9
	Red	451425-5
Plastic straight pipe 28	Red	451425-5
	Black	456587-4

28-K Flexible hose set28



Description	Color	Part No.
Flexible hose set28 Superior in flexibility and for the cleaning of the small place in the car	Ivory	191496-7
	White	198868-7
	Blue	198541-9
	Red	198542-7
	Pink	198871-8
	Black	198547-7

28-L Nozzle assembly

Flat type



F/C switching t-nozzle 28

Description	Color	Part No.	EU
			Part No.
F/C switching t-nozzle 28 Flooring & carpet	White	198183-9	198532-0
F/C switching t-nozzle 28 Flooring & carpet	Blue	199431-9	-

For Dust Collecting

W/ Ø28mm Hose
Model
DVC350 / DVC863L / DVC864L

W/ Ø38mm Hose
Model
DVC860L / DVC862L / DVC863L / DVC750L

W/ Ø28mm Hose
Model
DVC261 / DVC265

W/ Front cuffs
38 24 22

W/ Joint 22-38

W/ Front cuffs
38 24 22

Attachments

Cordless
Tangle-Free (MCL)

LED Flashlight
Tempo Switch, LED
COMBIBIT

Vacuum Cleaner
Tempo Switch
MCL

Drilling / Finishing
Conical / Triangular
MCL / MCL

Impact Drilling / Demolition
Conical / Perforated
ELECTRIC / PERFORATED

Cutting / Finishing
Perforated
MCL

Grinding / Sanding
Perforated / Perforated
MCL / MCL

Sanding
Conical
MCL

Planing / Routing
Perforated / Triangular
MCL / MCL

Chairs
MCL

Outdoor Power Equipment
Aluminum Frame Unit
MCL / MCL

Makita
TIME

Cordless
Trimmer / Hair Trimmer

LED Flashlight
Lamp / Lamp LED
LED / LED

Vacuum Cleaner
Power / Power Vacuum
掃除機

Drilling / Fastening
Drill / Drill
ドリル / 釘

Impact Drilling / Demolition
Drill / Power
ドリル / 破砕機

Cutting
Pruning / Pruning
刈り機

Grinding / Sanding
Grinder / Grinder
研削機 / 砂紙

Sawing
Saw / Saw
のこぎり

Planing / Routing
Planer / Router
のこぎり / 彫り機

Others
Accessories
その他

Outdoor Power Equipment
High Power Tool
高動力工具

Makita
MAKITA

Nozzle assembly

Floor/carpet t-nozzle
For rug / carpet cleaning



Description	Color	Part No.
Floor/carpet t-nozzle For rug / carpet cleaning	Ivory	198150-4
	White	198525-7
	Blue	198523-1
	Red	198524-9
	Pink	198883-1
	Black	198526-5

Nozzle assembly

Floor t-nozzle 28



Description	Color	Part No.
Floor-t-nozzle 28	Ivory	123485-4
	White	123486-2
	Blue	123488-8
	Black	123539-7
	White	122861-9
	Blue	122859-6

Nozzle assembly

For rug / carpet cleaning



Description	Color	Part No.
For rug / carpet cleaning	Ivory	122291-4

Nozzle assembly

Seat nozzle 28



Description	Color	Part No.
Seat nozzle 28 For car seat	White	199038-1
	Blue	199041-2
	Black	199039-9

28-M

Round brush 28



Color	Part No.
Ivory	198552-4
White	198878-4
Blue	198549-3
Red	198550-8
Pink	198880-7
Black	198551-6

28-N

Corner nozzle 330-28

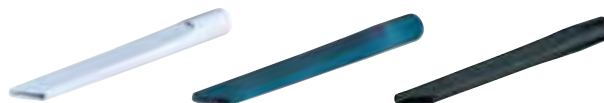

Size	Color	Part No.
330-28mm	White	198919-6
	Blue	198990-0
	Black	198992-6

28-O

Sash nozzle 28 and Long Sash nozzle 415

Sash nozzle 28

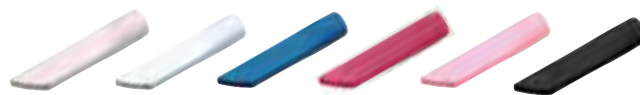

Long Sash nozzle 415



Description	Color	Part No.
Sash nozzle 28	Ivory	416041-0
	White	451240-7
	Blue	451243-1
	Red	-
	Pink	-
Crevice nozzle 415 set	Black	456586-6
	White	199439-3

28-P

Shelf brush set 28

(For gentle cleaning by soft-tipped brush)



Color	Part No.	EU	
		Part No.	
Ivory	191724-0	198537-0	
White	198872-6	198873-4	
Blue	198534-6	-	
Red	198535-4	-	
Pink	198875-0	-	
Black	198536-2	-	

28-Q

Flexible rubber nozzle



Color	Part No.	EU	
		Part No.	
grey	197900-4	197901-2	

28-I

Tapered nozzle set

Use with Front cutts 22 or Flexible rubber nozzle



Color	Part No.
grey	192236-6

Cordless Cleaner for Capsule type

For Model:
CL183D, DCL181F, DCL180, CL111D, CL106FD, CL070D
Filter



Pre filter

Easy shake off dust filter

Description	Per pkg.	Part No.	EU	
			Part No.	
Filter	10	198914-6	-	
Pre filter	1	198750-0	198751-8	
Easy shake off dust filter	1	455176-2	-	

Cordless Cleaner for Paper bag type

For Model:
DCL182, CL121D, CL107FD, CL105D, CL104D, CL072D
Paper filter



Dust bag

Easy shake off dust bag

Description	Per pkg.	Part No.
Paper filter Anti-bacterial type	10	194565-3
	5	194566-1
Dust bag	1	198746-1
Easy shake off dust bag	1	198748-7

Other Cleaners

For DVC261, DVC265

Dust bag assembly



Filter bag set (Paper dust bag)

Description	Per pkg.	Part No.
Dust bag assembly	1	197898-5
Filter bag set (Paper dust bag)	10	197902-0

Hose



Description	Size	Part No.
without front sleeve	28mm-1m	143787-2

Bending pipe assembly

*with Hose 28 sleeve



Description	Part No.
For Aluminum Telescopic pipe assembly with lock	*127093-3
Bent pipe assembly for DVC260	123677-5

Cordless
Tapered Nozzle
LED Flashlight
Tapered Nozzle, LED
COMBIBIT
Vacuum Cleaner
Tapered Nozzle
US
Drilling / Finishing
Cone / Tapered
NOZ / 28
Impact Drilling / Demolition
Cone / Tapered
NOZ / 28
Cutting / Finishing
Tapered
NOZ
Grinding / Sanding
Tapered / Tapered
NOZ / 28
Sanding
Cone
NOZ
Planing / Routing
Perforated / Tapered
NOZ / 28
Cone
NOZ
Outdoor Power Equipment
Aluminum Pipe Unit
28mm-57mm
Makita
TIME

Cordless
Brush Roll (10.5x2)

LED Flashlight
Lamp (SMD) LED
(LED) (10.5x2)

Vacuum Cleaner
Perforation Vacuum
(10.5x2)

Drilling / Fastening
Dowel / Plug
(10.5x2)

Impact Drilling / Demolition
Dowel / Plug
(10.5x2)

Cutting
Pushing
(10.5x2)

Grinding / Sanding
Grinding / Sanding
(10.5x2)

Sawing
Sawing
(10.5x2)

Planing / Routers
Planing / Routers
(10.5x2)

Others
Others
(10.5x2)

Outdoor Power Equipment
High Power Unit
(10.5x2)

Makita
1941

For CL121D

Mat nozzle 120



Seat nozzle 120 complete



Rubber nozzle 330



Soft brush 360 complete



Description	Part No.
Mat nozzle 120	459056-4
Seat nozzle 120 complete	140H95-0
Rubber nozzle 330	422437-5
Soft brush 360 complete	140H94-2

For DRC200

Boundary line tape (15m roll)



Side brushes



Power brush



Turn brush cover



Filter



Description	Part No.
Boundary line tape (15m roll)	SH00000240 (USA, AU)
Side brushes	SH00000065
Power brush	SH00000063
Turn brush cover	SH00000064
Filter	SH00000213

For DVC350

Dust bag



Part No.
122918-6

Nozzle assembly



Model No.	Size(mm)	Part No.
DVC350	220	132025-7
	430	134182-7

Quick charger

(AC only)



Model No.	Charging time (min.) (approx.)	Part No.
CL104D, CL105D, CL111D	180	DC1001 / 196832-2

For DCL501



	Type	Part No.
Hose	-	SH00000034
Straight pipe	Adjustable length	SH00000060
Nozzle assembly	Flooring & carpet	SH00000058
Crevice nozzle	-	SH00000042

Flexible hose set

(Total length: 95cm)



Model No.	Part No.
DUB182, UB1100, UB1101	191750-9

VACUUM CLEANER

Automatic Self-cleaning Filtration System achieved by two filter units

Sistem Penapis Penyucian Automatik 自动清洗过滤系统

Constantly high suction power throughout operation because dust is removed from Prefilters every 10 seconds during operation

Kuasa penyedut yang berterusan sepanjang operasi kerana habuk dikeluarkan dari penapis setiap 10 saat semasa operasi
在整个运行过程中吸力保持在较高的水平，因为在运行过程中，每10秒就会从过滤器中除去灰尘

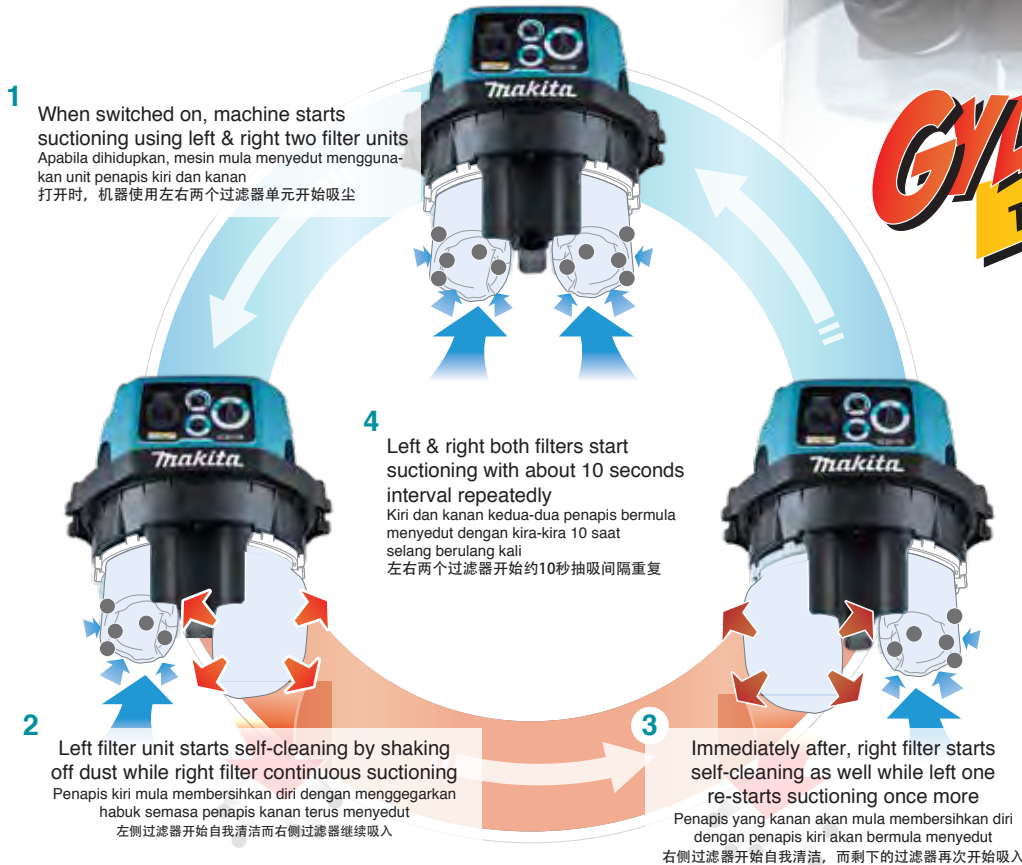

VC3211M

Vacuum Cleaner (Wet & Dry)
Pembersih Vakum (Basah Dan Kering)
吸尘器(干湿两用)



- 32L Large dust bag capacity enables continuous cleaning work
Kapasiti debu 32L besar boleh membersihkan secara berterusan
32L大容量尘袋可延续清洁工作

Standard Equipment: Hose, Holder 10-33, Front Cuffs (22, 24, 38), Cloth Filter, Poly Bag Set 10pcs



Dust Class M
Debu Kelas M | 集尘等级M

WET Basah 湿
DRY Kering 干



AUTOMATIC Self-cleaning Filtration System
Sistem Penapis Penyucian Automatik
自动清洗过滤系统

Continuous Rating Input Kuasa Sedutan 额定输入功率	1,050W
Max Peak Air Flow Aliran Udara 最大空气流量	2.0m ³ /min
Max Sealed Suction (water column) Sedutan Terkedap (Turus Air) 最大密封吸力(水柱)	22.0kPa (2,240 mmH ₂ O)
Tank Capacity Kapasiti 容量	Dust: 32L Water: 27L
Dimensions (L x W x H) Dimensi 体积	552x398x685mm (21-3/4"x15-5/8"x27")
Net Weight Berat Bersih 净重	16.9kg (37.3lbs)
Power Supply Cord Kabel Wayar 电源线	5.0m (16.4ft)

VC2211M

Vacuum Cleaner (Wet & Dry)
Pembersih Vakum (Basah Dan Kering)
吸尘器(干湿两用)



- Approved for Dust Class M in accordance with the EU standard
Diluluskan oleh piawaian EU untuk menyedut debu kelas M
依欧盟标准，集尘等级M

Standard Equipment: Hose, Front Cuffs (22, 24, 38), Belt Hook, Hose Band, Cap, Poly bag 800x650, Poly Bag Set 10 pcs



Dust Class M
Debu Kelas M | 集尘等级M

WET Basah 湿
DRY Kering 干



AUTOMATIC Self-cleaning Filtration System
Sistem Penapis Penyucian Automatik
自动清洗过滤系统

Continuous Rating Input Kuasa Sedutan 额定输入功率	1,050W
Max Peak Air Flow Aliran Udara 最大空气流量	2.0m ³ /min
Max Sealed Suction (water column) Sedutan Terkedap (Turus Air) 最大密封吸力(水柱)	22.0kPa (2,240 mmH ₂ O)
Tank Capacity Kapasiti 容量	Dust: 22L Water: 17L
Dimensions (L x W x H) Dimensi 体积	552x398x569mm (21-3/4"x15-5/8"x22-3/8")
Net Weight Berat Bersih 净重	16.3kg (35.9lbs)
Power Supply Cord Kabel Wayar 电源线	5.0m (16.4ft)

Cordless
Tawar Kord (无绳)

LED Flashlight
Lampu Suka-Led (LED灯)

Vacuum Cleaner
Pembersih Vakum (吸尘器)

Drilling / Finishing
Guaian / Pengiraan (钻孔 / 磨光)

Impact Drilling / Demolition
Guaian / Pengiraan (冲击钻孔 / 拆除)

Cutting / Routing
Pangkas / Pengiraan (切割 / 磨光)

Grinding / Sanding
Mengekil / Pengiraan (磨光 / 磨光)

Planing / Routing
Pengiraan / Pengiraan (刨平 / 磨光)

Chains
Lantai (链条)

Outdoor Power Equipment
Alatan Kuasa Luar (户外动力设备)

Makita
TAMBAH

VACUUM CLEANER

Automatic self-cleaning filter (VC1310L, VC2510L, VC3210L)

Sistem Penapis Penyucian Automatik 自动清洗过滤系统

obtained by Triple filter structure composed of: Powder filter + Damper + Prefilter
 Kuasa penyedutan yang berterusan sepanjang operasi kerana habuk dikeluarkan dari Prefilters setiap 10 saat semasa operasi
 由三重过滤器结构得到: 粉末过滤器+阻尼器+预过滤器

When the power is switched on, Prefilter collapses into itself to compress Damper, and fits closely over Damper and Powder filter.

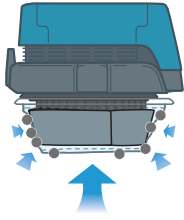

Apabila kuasa dihidupkan, Prefilter runtuh ke dalamnya untuk memampatkan Damper, dan sesuai dengan penapis Damper dan Serbuk. 当接通电源时, Prefilter会自行折叠以压缩阻尼器, 并紧密贴合阻尼器和粉末过滤器。

When the power is switched off, Damper expands back to its original size and shakes off dust from Prefilter automatically with its expanding power.

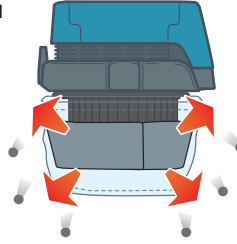

Apabila kuasa dimatikan, Damper mengembang kembali ke saiz asalnya dan mengelakkan habuk dari Prefilter secara automatik dengan kuasa yang berkembang. 当电源关闭时, 阻尼器膨胀回到其原始尺寸, 并通过扩展的功率自动将Prefilter的灰尘抖落。



VC3210L

173 W

Vacuum Cleaner (Wet & Dry)
 Pembersih Vakum (Basah Dan Kering)
 吸尘器(干湿两用)



Dust Class L
 Debu Kelas L | 集尘等级L
WET Basah 湿
DRY Kering 干

- For both wet and dry vacuum cleaning untuk menyedut kotoran kering atau lembap 适用于干和湿集尘清洁

Standard Equipment: Floor Nozzle, Corner Nozzle, Straight Pipe, Bent Pipe, Hose, Holder 10-33, Front Cuffs (22, 24, 38), Cloth Filter, Damper, Poly Bag Set (10pcs)



Continuous Rating Input Kuasa Sedutan 额定输入功率	1,050W
Max Peak Air Flow Aliran Udara 最大空气流量	2.0m ³ /min
Max Sealed Suction (water column) Sedutan Terkedap (Turus Air) 最大密封吸力(水柱)	22.0kPa (2,240 mmH ₂ O)
Tank Capacity Kapasiti 容量	Dust: 32L Water: 27L
Dimensions (L x W x H) Dimensi 体积	552x398x685mm (21-3/4"x15-5/8"x27")
Net Weight Berat Bersih 净重	14.5kg (32.0lbs)
Power Supply Cord Kabel Wayar 电源线	5.0m (16.4ft)

VC2510L

173 W

Vacuum Cleaner (Wet & Dry)
 Pembersih Vakum (Basah Dan Kering)
 吸尘器(干湿两用)



Dust Class L
 Debu Kelas L | 集尘等级L
WET Basah 湿
DRY Kering 干

- For both wet and dry vacuum cleaning untuk menyedut samaada kotoran kering atau lembap 适用于干和湿集尘清洁

Standard Equipment: Hose, Holder 10-33, Front Cuffs (22, 24, 38), Poly Bag, Poly Bag Set 10pcs



Continuous Rating Input Kuasa Sedutan 额定输入功率	1,050W
Max Peak Air Flow Aliran Udara 最大空气流量	2.0m ³ /min
Max Sealed Suction (water column) Sedutan Terkedap (Turus Air) 最大密封吸力(水柱)	22.0kPa (2,240 mmH ₂ O)
Tank Capacity Kapasiti 容量	Dust: 25L Water: 14L
Dimensions (L x W x H) Dimensi 体积	432x416x451mm (17"x16-3/8"x17-3/4")
Net Weight Berat Bersih 净重	10.5kg (23.2lbs)
Power Supply Cord Kabel Wayar 电源线	5.0m (16.4ft)

VC1310LX1

173 W

Vacuum Cleaner (Wet & Dry)
 Pembersih Vakum (Basah Dan Kering)
 吸尘器(干湿两用)



Dust Class L
 Debu Kelas L | 集尘等级L
WET Basah 湿
DRY Kering 干

- For both wet and dry vacuum cleaning untuk menyedut samaada kotoran kering atau lembap 适用于干和湿集尘清洁

Standard Equipment: Hose, Holder 10-33, Front Cuffs (22, 24, 38), Poly Bag Set, Cleaning Set

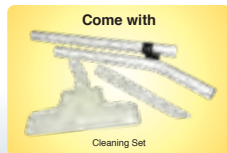

Continuous Rating Input Kuasa Sedutan 额定输入功率	1,050W
Max Peak Air Flow Aliran Udara 最大空气流量	2.0m ³ /min
Max Sealed Suction (water column) Sedutan Terkedap (Turus Air) 最大密封吸力(水柱)	22.0kPa (2,240 mmH ₂ O)
Tank Capacity Kapasiti 容量	Dust: 13L Water: 7L
Dimensions (L x W x H) Dimensi 体积	366x334x420mm (14-3/8"x13-1/8"x16-1/2")
Net Weight Berat Bersih 净重	9.6kg (21.2lbs)
Power Supply Cord Kabel Wayar 电源线	5.0m (16.4ft)

VC2000L

Vacuum Cleaner (Wet & Dry)
 Pembersih Vakum (Basah Dan Kering)
 吸尘器(干湿两用)

Dust Class L
 Debu Kelas L | 集尘等级L
WET Basah 湿
DRY Kering 干

- For both wet and dry vacuum cleaning untuk menyedut kotoran kering atau lembap 适用于干和湿集尘清洁

Standard Equipment: 3.5m x 32mm Hose, Heavy Duty PET Filter, Cloth Bag, Poly Bag Set, Hose Band, Floor Nozzle, Universal Nozzle, Crevice Nozzle, Straight Pipe x2



Continuous Rating Input Kuasa Sedutan 额定输入功率	1,000W
Capacity Kapasiti 尘袋容量	Dust: 20L Water: 13L
Max Air Flow Aliran Udara 最大空气流量	3.6m ³ /min
Max Sealed Suction Sedutan Terkedap 最大密封吸力	21kPa
Net Weight Berat Bersih 净重	7.5kg

Cordless
 LED Flashlight
 Vacuum Cleaner
 Drilling / Fastening
 Impact Drilling / Demolition
 Cutting / Pressing
 Grinding / Sanding
 Sawing
 Planing / Routing
 Others
 Outdoor Power Equipment



Filter & Dust bag



for Dust
(Powder)

- Powder Filter Set
- Damper set
- Pre-filter set
- Dust paper filter or Poly bag set

Compatible with usual Poly bags or Paper filters, allowing for:



- Quick and easy dust disposal
- Lower-running cost compared with paper dust bag



	DVC862L DVC860L	DVC864L DVC863L	VC3211H	VC3211M VC2211M VC2201M	VC3210L	VC2510L	VC1310L
	(Wet & Dry)	(Dry)	(Wet & Dry)	(Wet & Dry)	(Wet & Dry)	(Wet & Dry)	(Wet & Dry)
Powder Filter Set Dry only	*197166-6 	*197166-6 			195441-4 	195441-4 	195438-3
*HEPA filter							
Pre-filter set	195553-3 	195553-3 	196253-8 	196253-8 			195553-3
Cloth filter	140248-3 						
Damper set	195552-5 	195552-5 			195552-5 	195552-5 	195552-5
Filter for water set Water only	195555-9 						195555-9
Filter bag set 15L (5pcs) for dry dust	195557-5 	195557-5 				195557-5 	195557-5
Poly bag set (10pcs)	195432-5 	195432-5 	195440-6 	195440-6 	195440-6 	195440-6 	195432-5

Cordless
Tangle-Free Flex

LED Flashlight
Lamp Switch, LED
COMFORT

Vacuum Cleaner
Temperature
Control

Drilling | Finishing
Cement | Tiles
SIL | 3.2

Impact Drilling | Demolition
Chisel | Hammer
SIL | 3.2

Cutting | Framing
Frame
ULB

Grinding | Sanding
Angled | Flat
SIL | 3.2

Sanding
Caulk
SIL

Planing | Routing
Perforated | Triangular
SIL | 3.2

Others
SIL

Outdoor Power Equipment
Aluminum
SIL-CV

Makita
TIME

Vacuum Cleaner System charts

Hose connection
28mm

Hose connection
38mm

Hose connection
32mm

For Cleaning

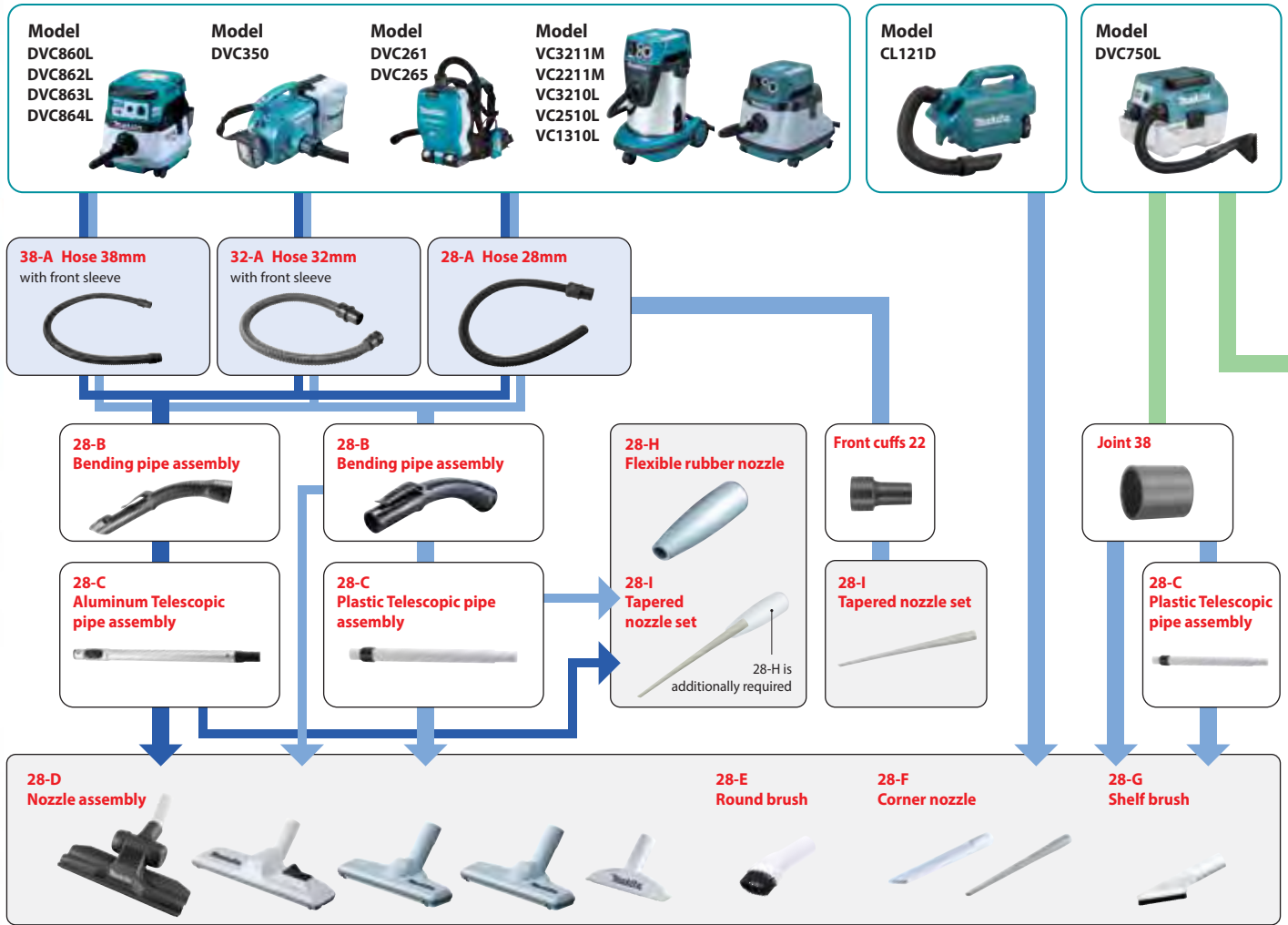

For Dust Collecting

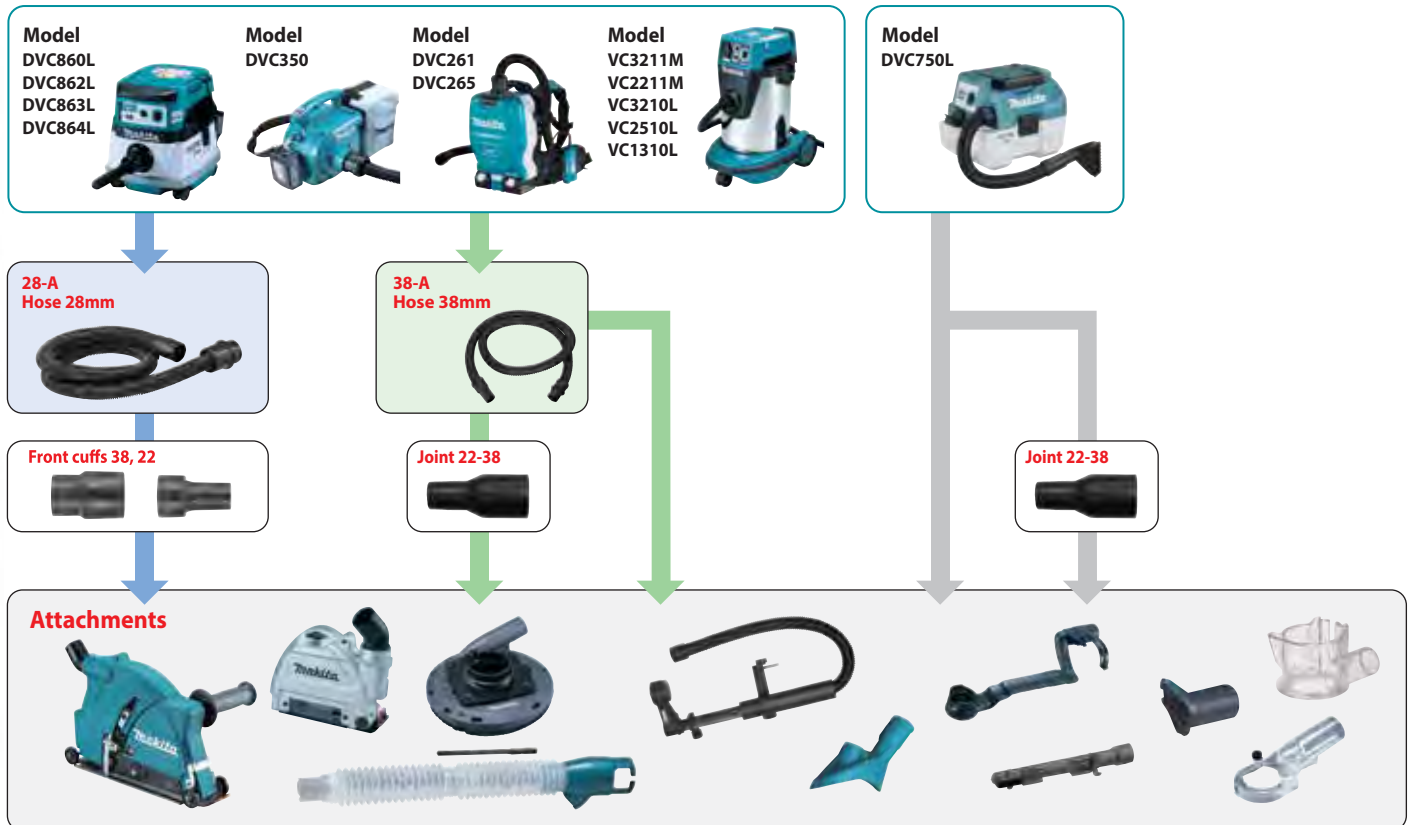

Cordless
Tethered Hand Tools

LED Flashlight
Lamp: SMD LED
Light: 1000lm

Vacuum Cleaner
Perforated Vacuum

Drilling / Fastening
Quick / Powerful
100% / 100%

Impact Drilling / Demolition
Strong / Powerful
15.5kg / 1.8kg

Cutting / Pushing
Powerful

Grinding / Sanding
Angular / Precision
3000 / 2000

Sawing
Heavy
100%

Planing / Routing
The system / Precise
100% / 100%

Others
Low noise
110%

Outdoor Power Equipment
High Power / Low
100% / 100%

Makita
100%

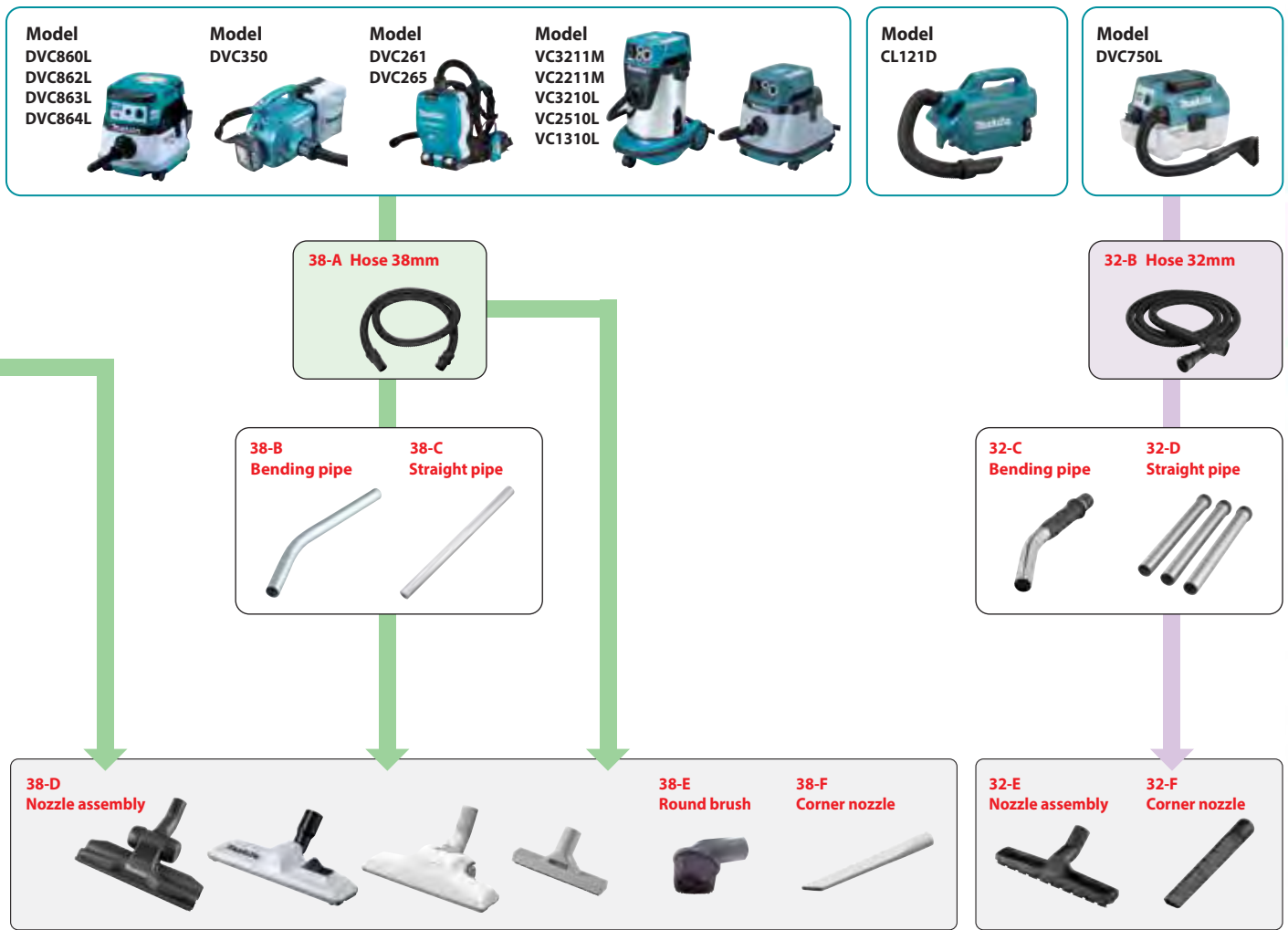

Front cuffs, Joint & Hose Connection

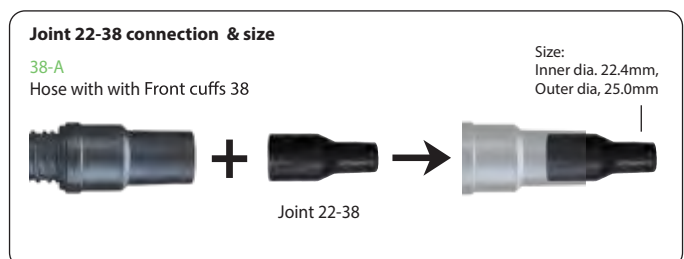
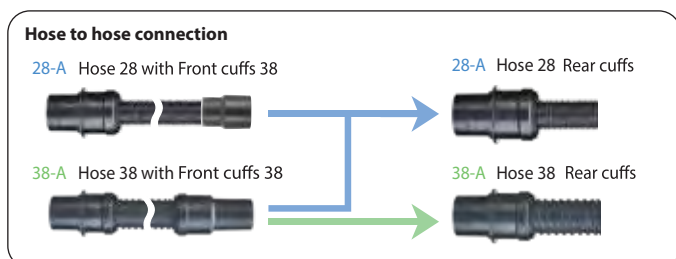
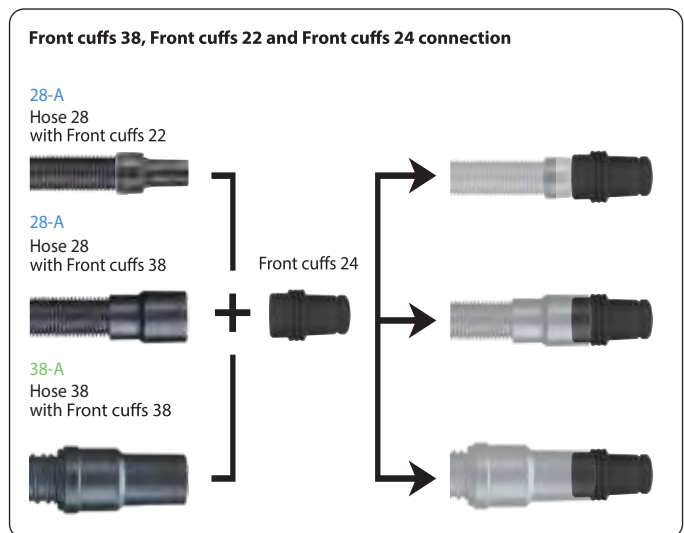
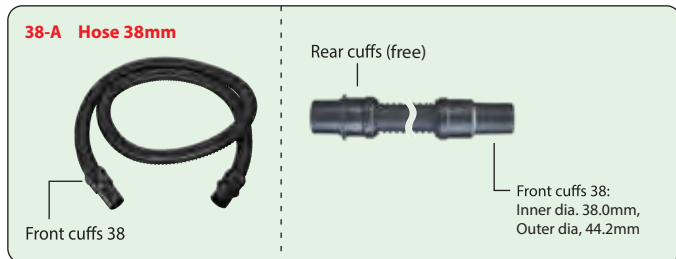
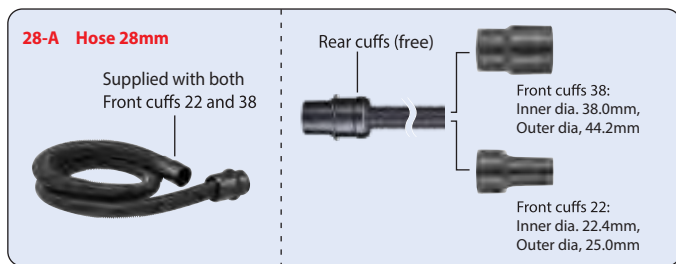

Cordless
Power Tool (MCL)

LED Flashlight
Temp. Scale, LED
COMBI

Vacuum Cleaner
Temp. Scale, Vacuum
COMBI

Drilling / Finishing
Cool / Triangular
BIT / BIT

Impact Drilling / Demolition
Cool / Triangular
BIT / BIT

Cutting / Finishing
Triangular
BIT

Grinding / Sanding
Triangular / Triangular
BIT / BIT

Sanding
Cool
BIT

Planing / Routing
Perforated / Triangular
BIT / BIT

Chains
Aluminum
BIT

Outdoor Power Equipment
Aluminum / Poly. Urea
BIT / BIT

Makita
TIME

System charts

A



W/ Ø28mm Hose

Model
VC3211M
VC2211M
VC3210L

W/ Front cuffs



B

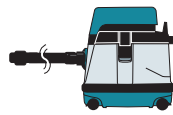

W/ Ø28mm Hose

Model
VC2510L
VC1310L
DVC863L
DVC864L

W/ Front cuffs



C



W/ Ø28mm Hose

Model
DVC350

W/ Front cuffs



D



W/ Ø38mm Hose

Model
DVC860L
DVC862L
DVC863L
DVC750L

W/ Joint 22-38



E



W/ Ø28mm Hose

Model
DVC261
DVC265

W/ Front cuffs



For Model

Suction Systems and Part No.

Rotary Hammer, Demolition Hammer

SDS-MAX, 17mm (11/16") Hex:
Bull points with over 280mm length
Cold chisels with over 280mm length

SDS-MAX only:

Scaling chisel (for tile),
Bushing tool
Scaling chisels length

19mm (3/4") Hex only

Scaling chisels

17mm (11/16") Hex:

HM0830, HR3530, HR4030C

SDS-MAX:

HR4001C/02/10C/11C,
HR4501C/10C/11C,
HR3540C/41FC
HM0870C/71C,
HM1101C/11C,
HM1203C/13C, HM1214C
HR4501C/10C/11C, HR4013C
HR4003C, HR3540C/41FC

**DHR400, HR5202C,
HR5212C, HM1205**

19mm (3/4") Hex:

HR4041C

Dust extractor attachment set

(Hammering mode only)
199144-2 (w/hose for)
199143-4 (w/o hose for)

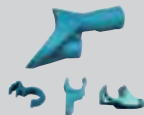

ø28mm hose can be directly connected.

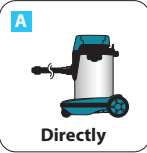

Directly



Directly



Directly



ø28mm hose



Directly

Electric Breaker

HM1304/B, HM1306,
HM1317C/CB, HM1307C/CB,
HM1400, HM1500/B, HM1810,
HM1801, HM1812, HM1802

Vacuum attachment set



197168-2 (w/o hose for)

197148-8 (w/ hose for)

ø28mm hose can be directly connected.



For Model

Suction Systems and Part No.

Rotary Hammer, Combination Hammer
see page 150

DHR242, HR2650, HR2651,
HR2652, HR2653, HR2661,
HR2663, DHR280, DHR282,
HR2300, HR2600, HR2601,
HR2601F, HR2630, HR2631F,
HR2641
DHR243, HR2651T, HR2653T, —195179-1
HR2300T, HR2320T, HR2630T,
HR2631FT,

DHR164, DHR165, DHR171, —198362-9
DHR182, HR140D, HR166D,
HR1840, HR1841F, HR2800,
HR2810, HR2811F, DHR202,
DHR241, DHR263, HR2230,
HR2460, HR2460F, HR2470,
HR2475

Rotary Hammer, Combination Hammer
DHR164, DHR165
DHR202, BHR262/T
DHR263, DHR264

HR2470 series
HR2800 series

Rotary Hammer
HR4002, HR4011C, —195866-2
HR4010C, HR4001C,
HR4511C, HR4510C, HR4501C

DHR400, HR4013C, HR4003C —199142-6
HR5212C, HR5202C —196858-4



Dust cup set
195173-3

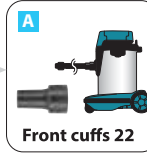
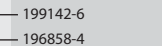
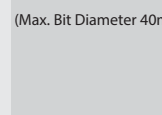
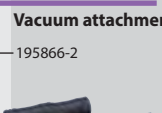

Front cuffs 22

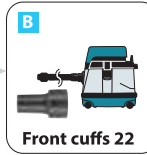

Front cuffs 22



Front cuffs 22



Joint 22-38
195548-6



Front cuffs 22

(Max. Bit Diameter 40mm)

Cordless
Durable Front Rollers

LED Flashlight
Lamp: SMD LED
LED: 9000

Vacuum Cleaner
Perforated Vacuum
3.5L/3.5

Drilling / Fastening
Durable / Powerful
1000 / 1000

Impact Drilling / Demolition
Durable / Powerful
1000 / 1000

Cutting / Pushing
Durable / Powerful
1000 / 1000

Grinding / Sanding
Durable / Powerful
1000 / 1000

Sawing
Durable / Powerful
1000 / 1000











Planing / Routing
Durable / Powerful
1000 / 1000

Others
Durable / Powerful
1000 / 1000









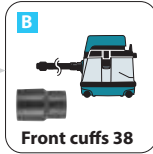
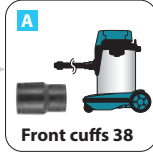



Outdoor Power Equipment
Durable / Powerful
1000 / 1000

Makita
19142-6

System charts

For Model	Suction Systems and Part No.
Angle Cutter 4112H 4112HS 4114 4114S 	Elbow joint 32 192613-2 
Dustless Cutter 4105KB 	Elbow joint 32 192613-2 
Dustless Cutter 4100KB 	
Cutter With Dust Collection 4157KB 	
Wall Chaser SG1251, SG1250 	
Concrete Planer PC5000C, PC5001C PC5010C 	
Angle Grinder 	Dust collecting wheel guard For cup type diamond wheel 
For 115, 125mm Model Single notch ——— w/o mark of origin 195237-3 Triple notches ——— w/o mark of origin for IEC 195239-9 w/ mark of origin for IEC 195238-1 North America package 195236-5 North America package for UL 196575-6	
For 180,230mm Model w/ mark of origin for IEC 195384-0 w/o mark of origin for IEC 195385-8 North America package for UL 197584-8	
Twin notches ——— w/ mark of origin 195387-4 w/o mark of origin 195388-2 North America package 195386-6	



For Model	Suction Systems and Part No.
Angle Grinder 	Dust collecting wheel guard 
For 125mm Model ——— 196845-3 196846-1	
	
For 230mm Model ——— 198379-2 198380-7	
Angle Grinder 	Dust collecting wheel guard 
For 115, 125mm Model ——— 192968-5 193794-5 (Economy type) For 180mm Model ——— 194303-3 For 230mm Model ——— 194044-1	
Belt Sander 9924DB 	Joint 32 192518-6 
Belt Sander 9404, 9902, 9903, 9910, 9911, 9920, 	
Belt Sander 9403, 9921 	Joint 32 192349-3 
Wheel Sander 9741 	Joint 410899-9 

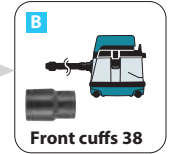
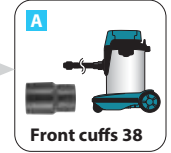

Cordless
 LED Flashlight
 Vacuum Cleaner
 Drilling / Finishing
 Impact Drilling / Demolition
 Cutting / Forming
 Grinding / Sanding
 Sawing
 Planing / Routing
 Others
 Outdoor Power Equipment



System charts

Cordless
Durable Acid Resistant

LED Flashlight
Lamp: SMD LED
LED: 100000

Vacuum Cleaner
Perforation Vacuum

Drilling / Fastening
Drywall / Plaster /
G.I.P. / G.I.P.

Impact Drilling / Demolition
Drywall / Plaster /
G.I.P. / G.I.P.

Cutting / Precision
Cutting

Trimming / Sanding
Drywall / Plaster /
G.I.P. / G.I.P.

















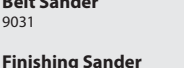

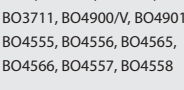
Sanding
Drywall / Plaster /
G.I.P. / G.I.P.

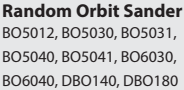
Planing / Routing
Drywall / Plaster /
G.I.P. / G.I.P.







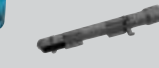





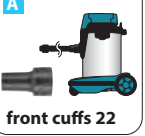
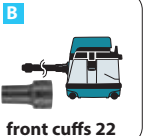





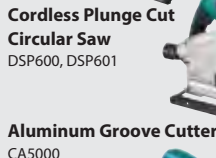

Others
Drywall / Plaster /
G.I.P. / G.I.P.

Outdoor Power Equipment
High Power /
G.I.P. / G.I.P.

Makita
1914

For Model	Suction Systems and Part No.
Disc Grinder N9500N, 9500NB 	Dust collecting wheel guard 192212-0  Rubber sleeve 192202-3
Angle Grinder For 100mm Model  For 115,125mm Model	Dust collecting wheel guard Dust collecting 100C set — 198413-8 Dust collecting 100CD set — 198414-6  198415-4
Belt Sander 9032 	Dust nozzle assembly 122652-8 
Belt Sander 9031 	
Finishing Sander 9046, BO3700, BO3710, BO3711, BO4900/V, BO4901 BO4555, BO4556, BO4565, BO4566, BO4557, BO4558 	
Random Orbit Sander BO5012, BO5030, BO5031, BO5040, BO5041, BO6030, BO6040, DBO140, DBO180 	
Multi Tool DTM50, DTM40 — 195965-0 TM3000C — 196022-7 TM3010C — 196550-2 	Dust attachment set  DTM51, DTM41 — 196765-1
Circular Saw DHS630 — 194314-8 DSS611, DSS610 — 419283-5 DSS501, DSS500 — 194415-2 HS300D, HS301D — 195334-5 	Joint (Dust nozzle) 
Jig Saw JV100D JV143D JV183D 4326, 4327, 4328, 4329 JV0600 	
Jig Saw DJV140, DJV180 4350T/CT/FCT, 4351T/CT/FCT 	Dust Nozzle 417853-4 

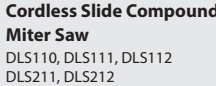

For Model	Suction Systems and Part No.
	front cuffs 24 195546-0 
Circular Saw HS6100, HS6101, HS7100, HS7101 — 453289-3 DHS710, HS6600, HS6601, HS7010, HS7600, HS7601, HS7610, HS7611 — 196520-1 HS6600, HS7000, HS7600, DHS711 — 196843-7 (with short lever) 5007N, 5007NF — 199712-1 (with short lever) HS0600 — 198263-1 DHS680 — 198265-7 (with short lever) 196961-1 196952-2 (with short lever) HS7000, HS7600 — 196520-1 197221-4 (with short lever)	Joint (Dust nozzle) 453289-3  front cuffs 22  front cuffs 22  front cuffs 22  front cuffs 22 
	Front cuffs 24 195546-0  Joint 22-38 195548-6 
Plunge Cut Circular Saw SP6000 	Front cuffs 24 195546-0  front cuffs 22 
Cordless Plunge Cut Circular Saw DSP600, DSP601 	 Aluminum Groove Cutter CA5000 
Cordless Jig Saw DJV141, DJV142 — 126331-0 DJV181, DJV182 — 457801-1 DJV102D, JV103D — 457801-1 	Dust nozzle assembly 126331-0  Front cuffs 24 195546-0 
Slide Compound Saw LS1019/L, LS1219/L 	Front cuffs 24 195546-0 
Cordless Slide Compound Miter Saw DLS110, DLS111, DLS112 DLS211, DLS212 	

System charts

For Model	Suction Systems and Part No.
Cordless Slide Compound Miter Saw DLS713 DLS714	
Slide Compound Saw LS0714/F/FL/L LS0815F/FL LS1016L LS1017L LS1018/L LS1216/L	
Miter Saw LS1030N, LS1440	
Compound Miter Saw LS1040/F, LS1045, LS1221	
Cordless Compound Miter Saw DLS600	
Flip Over Saw LF1000	
Table Top Miter Saw LH1040/F LH1201FL	

For Model	Suction Systems and Part No.	
Table Saw 2704N, 2705	Joint 419093-0	
Table Saw 2703	Joint 55 192799-2	
Table Saw MLT100N	Dust point JM27000090	
Table Saw 2712		
Band Saw LB1200F	Joint 419093-0	



Cordless
 Power Tool (MCT)

LED Flashlight
 (Energy Saver) LED
 LIGHT

Vacuum Cleaner
 (Temporary Vacuum)
 (MCT)

Drilling / Finishing
 (General Purpose)
 (MCT)

Impact Drilling / Demolition
 (General Purpose)
 (MCT)

Cutting / Finishing
 (General Purpose)
 (MCT)

Grinding / Sanding
 (General Purpose)
 (MCT)

Sawing
 (General Purpose)
 (MCT)

Planing / Routing
 (General Purpose)
 (MCT)

Others
 (General Purpose)
 (MCT)

Outdoor Power Equipment
 (General Purpose)
 (MCT)

Makita
 THE LINE

System charts

Cordless
Durable Acid Resistant

LED Flashlight
Lamp: SMD LED
LED: 1000LM

Vacuum Cleaner
Performance Vacuum
3.5L/3.5L

Drilling / Fastening
Durable / Powerful
100V / 100W

Impact Drilling / Demolition
Durable / Powerful
15.1/17.1/18.8/21.5L

Cutting / Pushing
Durable / Powerful

Trimming / Sanding
Durable / Powerful
100V / 100W







Sawing
Durable / Powerful
100V

Planing / Routing
Durable / Powerful
100V / 100W

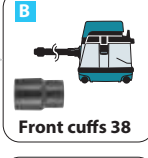



Others
Durable / Powerful
100V

Outdoor Power Equipment
Durable / Powerful
100V / 100W

Makita
Durable / Powerful
100V

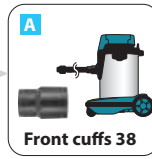
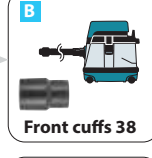
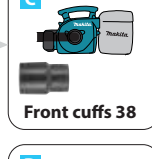
For Model	Suction Systems and Part No.
Circular Saw 5603R, 5704R, 5705R ——— 192420-3 5143R ——— 192490-2 5008MG ——— 450079-5 ——— 194489-3 (with short lever) 5103R, 5903R ——— 192419-8 5104S, 5104 ——— 450316-7 N5900B, 5902B ——— 193823-9 ——— 193068-4 (with short lever)	Joint (Dust nozzle)  Front cuffs 38  Front cuffs 38  Front cuffs 38  Front cuffs 38  Front cuffs 38
Circular Saw 5604R, 5037NB	 Front cuffs 38
Dustless Circular Saw 5017RKB 5057KB	 Front cuffs 38

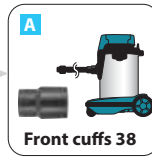
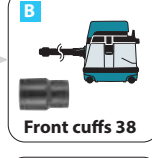
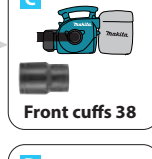
***C: DVC350 Cannot be used with Planer models**

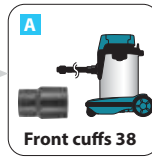
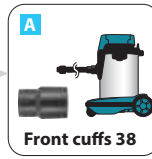
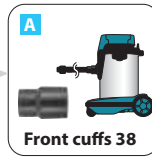
For Model	Suction Systems and Part No.
Power Planer 1050D, 1051D KP0810/C	 Front cuffs 38  Front cuffs 38  Front cuffs 38  Front cuffs 38  Front cuffs 38
Power Planer DKP180, DKP140 KP0800	Nozzle 451329-1  Front cuffs 38  Front cuffs 38  Front cuffs 38  Front cuffs 38  Front cuffs 38
1805N ——— JPA122277	 Front cuffs 38
Power Planer 1911B	Nozzle for vacuum cleaner 192082-7  Front cuffs 38
Power Planer N1900B, N1923B, KP0800, 1804N 1805N, 1806B, KP312/S	 Front cuffs 38

***C: DVC350 Cannot be used with Planer models**



Nozzle assembly







Joint

*Elbow









Model No.	Part No.	Model No.	Part No.
N1900B, N1923B	181572-5	N1900B, N1923B	JPA122275 (122275-2)
KP0800, DKP180, DKP140	451329-1	DKP180, DKP140, KP0810/ C, KP0800	*416368-8
1804N	JPA122278 (122278-6)	1804N, 1805N, 1806B, KP312/S	181575-9
1805N	JPA122277 (122277-6)		
1806B	122397-8		
KP312/S	193733-5		

System charts

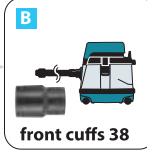
For Model	Suction Systems and Part No.
Plate Joiner PJ7000, 3901, DPJ180, DPJ140	 <p>A front cuffs 22</p>
Cut-out Tool 3706	 <p>B front cuffs 22</p>
Dust collection cover 193449-2	 <p>C * front cuffs 22</p>
Cordless Cut-out Tool DCO180	 <p>D Joint 22-38 195548-6</p>
Cordless Drywall saw DSD180, SD100D	 <p>E front cuffs 22</p>
Router RP0910, RP1110C	 <p>A front cuffs 22</p>

*C: DVC350 Cannot be used with Router models

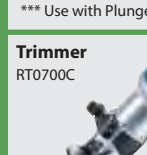

For Model	Suction Systems and Part No.
Router RP1801/ F RP1800/ F RP2301FC RP2300FC	Dust nozzle 194934-8
 <p>A front cuffs 38</p>	 <p>B front cuffs 38</p>
Router RD1100, RD1101, RF1100, RF1101, RP1100, RP1101	Dust nozzle 193379-7
 <p>C front cuffs 38</p>	 <p>D</p>
Router RP0900, ***RT0700C, DRT50	Dust nozzle 194733-8
Cordless Router DRT50	 <p>E front cuffs 38</p>
*** Use with Plunge base assembly	
Trimmer RT0700C	Dust nozzle 195559-1
 <p>A</p>	 <p>B</p>
Cordless Trimmer DRT50	

Makita recommend to use 38mm hose when you use Router



Cordless
 LED Flashlight
 Vacuum Cleaner
 Drilling / Finishing
 Impact Drilling / Demolition
 Cutting / Finishing
 Grinding / Sanding
 Sawing
 Planing / Routing
 Others
 Outdoor Power Equipment
Makita

Cordless
Brushless Motor (BLDC)

LED Flashlight
Lamp: SMD LED
LED: 1000lm

Vacuum Cleaner
Powerful Vacuum
2000Pa

Drilling / Fastening
Over 2000 RPM

Impact Drilling / Demolition
3000 RPM

Cutting
Pushing
Cutting

Grinding / Sanding
2000 RPM

Sawing
1800 RPM

Planing / Routing
1000 RPM

Others
Laminator
1000 RPM

Outdoor Power Equipment
High Power Unit
1000 RPM

Makita
1915

Front cuffs & Joint

Front cuffs 22



Front cuffs 24



Front cuffs 38



Joint 22-38



Joint 38



Joint H



Rubber sleeve 18-21



Type	Part No.
Front cuffs 22	195547-8
Front cuffs 24	195546-0
Front cuffs 38	195545-2
Joint 22-38	195548-6

Hose connection 28mm

28-A

Hose



Note:
Can be connected with power tools, Front cuffs and Joint are required for some power tools.
*DVC260, DVC261, DVC265 only
* for cleaning (Use with Bending pipe assembly)

Size	Length (m)	with Front cuffs	Part No.
28mm	1.0	-	*143787-2
28mm	1.5	38	*152992-0
28mm	1.5	22, 38	A-34235
28mm	2.5	22, 24, 38	195437-5
28mm	3.5	22, 24, 38	195433-3
28mm	5	22, 24, 38	195436-7
28mm	5	22, 38	A-34229

28-B

Bending pipe

*with Hose 28 sleeve



Description	Part No.
For Aluminum (Part No. 140G19-0) Telescopic pipe assembly with lock	*127093-3
For plastic straight pipe 28 and Telescopic pipe assembly 28	*126756-8

28-C

Straight pipe



Description	Part No.
Aluminum Telescopic pipe assembly Pipe length is variably adjustable from 590 to 942mm.	140G19-0
Telescopic pipe assembly 28 Pipe length is variably adjustable from 500 to 850mm.	198560-5

28-D

Nozzle assembly

Flat type



F/C switching t-nozzle
Flooring & carpet

Floor/carpet t-nozzle
For rug / carpet cleaning

For rug / carpet cleaning

Floor t-nozzle 28

Seat nozzle 28
For car seat

Description	Color	Part No.	EU
			Part No.
F/C switching t-nozzle 28 Flooring & carpet	White	198183-9	198532-0
Floor/carpet t-nozzle For rug / carpet cleaning	White	198525-7	-
	Black	198526-5	-
Floor t-nozzle 28	White	123486-2	-
Seat nozzle 28 For car seat	White	-	199038-1
	Black	-	199039-9

28-E Round brush



Color	Part No.
White	198878-4
Black	198551-6

28-F Corner nozzle

Type	Color	Part No.
300-28mm	White	198919-6
	Black	198992-6
Crevice nozzle 415 set	White	199439-3

28-G Shelf brush

(For gentle cleaning by soft-tipped brush)



Color	Part No.	EU
		Part No.
White	198872-6	198873-4
Black	198536-2	-

28-H Flexible rubber nozzle



Color	Part No.	EU
		Part No.
grey	197900-4	197901-2

28-I Tapered nozzle set

Use with Front cutts 22 or Flexible rubber nozzle



Color	Part No.
grey	192236-6

Hose stand

For model
VC1310L, VC2211M, VC2510L,
VC3210L, VC3211M



Part No.

197323-6

Holder set 10-33



Part No.

195544-4



Cordless
Tapered Nozzle

LED Flashlight
Tapered Nozzle
LED LIGHT

Vacuum Cleaner
Tapered Nozzle
LED LIGHT

Drilling / Finishing
Cordless / Tapered
NOZZLE

Impact Drilling / Demolition
Cordless / Tapered
NOZZLE

Cutting / Finishing
Cordless / Tapered
NOZZLE

Grinding / Sanding
Cordless / Tapered
NOZZLE

Sanding
Cordless / Tapered
NOZZLE

Planing / Routing
Cordless / Tapered
NOZZLE

Others
Cordless / Tapered
NOZZLE

Outdoor Power Equipment
Cordless / Tapered
NOZZLE

Makita
THE LINE

Cordless
Tethered Hand Tools

LED Flashlight
Lampy SMD/LED
LED/WRIT

Vacuum Cleaner
Perumahan Vacuum
3.5.2016

Drilling / Fastening
Dagang / Pasang
10.11.2016

Impact Drilling / Demolition
Dagang / Pasang
15.11.2016

Cutting
Proteksi
01.11.2016

Grinding / Sanding
Dagang / Pasang
10.11.2016

Sawing
Dagang / Pasang
05.11.2016

Planing / Routing
Dagang / Pasang
10.11.2016

Others
Lain-lain
11.11.2016

Outdoor Power Equipment
High Power Tools
08.11.2016

Makita
1915

Hose connection 38mm

38-A

Hose 38mm

for cleaning

*Use with 28-B Bending pipe assembly



Size	Length (m)	with Front cuffs	Part No.
38mm	2.5	38	195434-1
38mm	5	38	195435-9

Cleaning set

Includes one each of:

- Hose complete 38-2.5
- Straight pipe
- Bending pipe
- Nozzle assembly
- Corner nozzle



Part No.
195439-1

38-B

Bending pipe



Description	Part No.
Aluminum	192562-3

38-C

Straight pipe



Description	Part No.
Aluminum	192563-1

38-D

Nozzle assembly

Flooring & carpet



Universal Type



Compact Type A



Compact Type B
(wet model only)



Wide Type
(wet model only)



Description	Dry/ Wet	Part No.	EU
			Part No.
Flooring & carpet	Dry	198184-7	-
Universal Type	Dry/ Wet	195551-7	-
Compact Type A	Dry	195549-4	122334-2
Compact Type B	Wet	195550-9	-
Wide Type	Wet	A-47846	-

38-E

Round brush



Type	Color	Part No.
38mm	Black	191657-9

38-F

Corner nozzle



Type	Color	Part No.
38mm	Yellow grey	410306-2

DRILLING FASTENING

Penggerudian | Mengetat 钻孔 | 紧固



DF0300 10mm (3/8")

411

Driver Drill

Gerudi Pemutar Skru
螺丝起子电钻



- **Compact Design with a Short Overall Length**
Reka bentuk padat dan pendek
紧凑小巧的设计

Standard Equipment: (+)(-) Bit



Continuous Rating Input Input Kuasa Berterusan 额定输入功率	320W
Capacity Kapasiti 能力	Steel: 10mm (3/8") Wood: 28mm (1-1/8")
Chuck Capacity Kapasiti Chuck 夹头能力	1.0 - 10mm (1/32 - 3/8")
No Load Speed (RPM) Kelajuan Tanpa Beban 回转数	High: 0 - 1,500 Low: 0 - 450
Max Fastening Torque Tenaga Pemutaran Pengancing Maksimum 最快扭转	Hard 56.0N-m (500in.lbs.) Soft: 21.0N-m (190in.lbs.)
Max Lock Torque Pemutaran Tenaga Maksimum 最大锁定扭力	42.0N-m (370in.lbs.)
Dimensions (L x W x H) Dimensi 体积	220x67x206mm (8-5/8"x2-5/8"x8-1/8")
Net Weight Berat Bersih 净重	1.2kg (2.7lbs.)
Power Supply Cord Kabel Wayar 电源线	2.5m (8.2ft)

DP2010 6.5mm (1/4")

419

High Speed Drill

Gerudi Kelajuan Tinggi
高速钻



- **Compact and high power**
Kuasa tinggi dan padat
紧凑和高功率

Standard Equipment: Chuck Key



Continuous Rating Input Input Kuasa Berterusan 额定输入功率	370W
Capacity Kapasiti 能力	Steel: 6.5mm (1/4") Wood: 15mm (9/16")
No Load Speed (RPM) Kelajuan Tanpa Beban 回转数	0-4,200
Dimensions (L x W x H) Dimensi 体积	209x64x175mm (8-1/4"x2-1/2"x6-7/8")
Net Weight Berat Bersih 净重	1.0kg (2.2lbs.)
Power Supply Cord Kabel Wayar 电源线	2.0m (6.6ft)

6305 13mm (1/2")

303

Drill

Gerudi
电钻



- **Heavy duty motor**
Motor tugas berat unggul
卓越马达

Standard Equipment: Chuck Key, Depth Gauge, Side Grip



Continuous Rating Input Input Kuasa Berterusan 额定输入功率	850W
Capacity Kapasiti 能力	Steel: 13mm (1/2") Wood: 30mm (1-3/16")
No Load Speed (RPM) Kelajuan Tanpa Beban 回转数	1,450
Dimensions (L x W x H) Dimensi 体积	346x84x152mm (13-5/8"x3-5/16"x6")
Net Weight Berat Bersih 净重	2.8kg (6.2lbs.)
Power Supply Cord Kabel Wayar 电源线	2.5m (8.2ft)

6413 10mm (3/8")

64

Drill

Gerudi
电钻



- **General Purpose Drill Featuring Compact And Lightweight Design**
Reka Bentuk Kompak Dan Ringan untuk penggerudian
tujuan umum
紧凑轻巧机身适合一般用途



Continuous Rating Input Input Kuasa Berterusan 额定输入功率	450W
Capacity Kapasiti 能力	Steel: 10mm (3/8") Wood: 25mm (1")
No Load Speed (RPM) Kelajuan Tanpa Beban 回转数	0-3,400
Dimensions (L x W x H) Dimensi 体积	234x64x183mm (9-1/4"x2-1/2"x7-1/4")
Net Weight Berat Bersih 净重	1.3kg (2.9lbs)
Power Supply Cord Kabel Wayar 电源线	2.0m (6.6ft)

Cordless
Tutupi Rod (RUL)

LED Flashlight
Lampu Suka LED
LED (RUL)

Vacuum Cleaner
Penyedut Vakum
BLUK

Drilling / Fastening
Gerudi / Pengancing
RUL / RUL

Impact Drilling / Demolition
Gerudi / Penanggalan
RUL / RUL

Cutting
Potong
RUL

Grinding / Smoothing
Mengecil / Mengkilap
RUL / RUL

Sawing
Gergaji
RUL

Planing / Routing
Meratakan / Mengukir
RUL / RUL

Others
Lain-lain
RUL

Outdoor Power Equipment
Alat Kuasa Luar
RUL / RUL

Makita
19157

Drilling | Fastening

Cordless
Tahan Bantukan

LED Flashlight
Lampu Senter LED
1.000.000

Vacuum Cleaner
Pembersih Vakuum
1.000.000

Drilling / Fastening
Drovo / Pengikat
1.000.000

Impact Drilling / Demolition
Drovo / Demolisi
1.000.000

Cutting
Pemotongan

Grinding / Sanding
Penggosok / Pasir
1.000.000

Sawing
Gergaji

Planing / Routing
Penghalus / Rute
1.000.000

Others
Lainnya

Outdoor Power Equipment
Alat Daya Luar
1.000.000

Makita
1.000.000



DS5000 16mm (5/8")

411

Drill
Gerudi
电钻



- **Powerful 750W motor for improved mixing and drilling performance**
Motor berkuasa 750W untuk prestasi pencampuran dan penggerudian yang lebih baik
强劲的750W马达提高混合和钻孔性能

Standard Equipment: Chuck Key, Top Grip



Continuous Rating Input Input Kuasa Berterusan 额定输入功率	750W
Capacity Kapasiti 能力	Steel: 16mm (5/8") Wood: 36mm (1-7/16")
No Load Speed (RPM) Kelajuan Tanpa Beban 回转数	600
Dimensions (L x W x H) Dimensi 体积	348x83x401mm (13-3/4"x3-1/4"x15-3/4")
Net Weight Berat Bersih 净重	3.0kg (6.6lbs)
Power Supply Cord Kabel Wayar 电源线	2.5m (8.2ft)

DS4012 13mm (1/2")

411

Drill
Gerudi
电钻

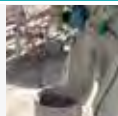

- **All-ball bearing construction for durability and longer tool life**
Struktur gelas bola untuk memanjangkan hayat alat
滚珠轴承结构延长工具寿命

Standard Equipment: Chuck Key, Top Grip



Continuous Rating Input Input Kuasa Berterusan 额定输入功率	750W
Capacity Kapasiti 能力	Steel: 13mm (1/2") Wood: 36mm (1-7/16")
No Load Speed (RPM) Kelajuan Tanpa Beban 回转数	0-600
Dimensions (L x W x H) Dimensi 体积	340x83x390mm (13-3/8"x3-1/4"x15-3/8")
Net Weight Berat Bersih 净重	2.8kg (6.2lbs)
Power Supply Cord Kabel Wayar 电源线	2.5m (8.2ft)

6016 16mm (5/8")

51

Drill
Gerudi
电钻

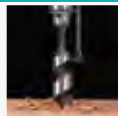

- **D-handle rotates 360 degrees for multi-position operation**
Pemegang-D berputar 360° memudahkan operasi
360° 旋转D型手柄方便操作

Standard Equipment: Chuck Key, Depth Gauge, Top Grip

Continuous rating input Input Kuasa Berterusan 额定输入功率	480W
Capacity Kapasiti 能力	Steel: 16mm (5/8") Wood: 36mm (1-3/8")
No Load Speed (RPM) Kelajuan Tanpa Beban 回转数	700
Overall Length Panjang Keseluruhan 总长度	365mm (14-3/8")
Net weight Berat Bersih 净重	4.4kg (9.7lbs)
Power supply cord Kabel Wayar 电源线	2.5m (8.2ft)

DRILLING | FASTENING

DA3010F 10mm (3/8")

419

Angle Drill Gerudi Sudut 角向电钻



- **Powerful 450W motor with less weight**
Motor berkuasa 450W dan ringan
轻量且强劲的450W马达



Standard Equipment: Chuck Key, Side grip 36 complete



Continuous Rating Input Input Kuasa Berterusan 额定输入功率	450W
Capacity Kapasiti 能力	Steel: 10mm (3/8") Wood: 25mm (1")
No Load Speed (RPM) Kelajuan Tanpa Beban 回转数	0-2,400
Overall Length Panjang Keseluruhan 总长度	270mm (10-5/8")
Net Weight Berat Bersih 净重	1.6kg (3.5lbs)
Power Supply Cord Kabel Wayar 电源线	2.5m (8.2ft)

TD0100

419

Impact Driver Pemutar Skru Impak 冲击螺丝起子机



- **Impacting mechanism for secure fastening**
Mekanisme impak untuk pengetatan yang kukuh
冲击机构确保紧固



Standard Equipment: Phillips Bit



Continuous rating input Input Kuasa Berterusan 额定输入功率	230W
Capacity Kapasiti 能力	Machine Screw: M4 - M8 (5/32" - 5/16") Standard Bolt: M5 - M14 (3/16" - 9/16") High Tensile Bolt: M5 - M10 (3/16" - 3/8") Coarse thread (in length): 22 - 90mm (7/8" - 3-1/2")
Driving Shank (Hex) Hex Memandu Aci 六角驱动轴	6.35mm (1/4")
Impacts Per Minute (IPM) Impak Per Minit 冲击数	0 - 3,200
No Load Speed (RPM) Kelajuan Tanpa Beban 回转数	0 - 3,600
Max Fastening Torque Maksimum Tenaga Pemutaran Pengancing 最快扭力	100N-m (74ft.lbs.)
Dimensions (L x W x H) Dimensi 体积	218x60x180mm (8-5/8"x2-3/8"x7-1/8")
Net weight Berat Bersih 净重	0.96kg (2.1lbs)
Power supply cord Kabel Wayar 电源线	2.5m (8.2ft)

TD0101F

411

Impact Driver Pemutar Skru Impak 冲击螺丝起子机



- **Enables to drive screws even without pre-drilling pilot holes**
Skru boleh digerudi walaupun tanpa lubang pra-penggerudian
即使没有预钻导孔也可以驱动螺钉



Standard Equipment: Phillips Bit



Continuous rating input Input Kuasa Berterusan 额定输入功率	230W
Capacity Kapasiti 能力	Machine Screw: M4 - M8 (5/32" - 5/16") Standard Bolt: M5 - M14 (3/16" - 9/16") High Tensile Bolt: M5 - M10 (3/16" - 3/8") Coarse thread (in length): 22 - 90mm (7/8" - 3-1/2")
Driving Shank (Hex) Hex Memandu Aci 六角驱动轴	6.35mm (1/4")
Impacts Per Minute (IPM) Impak Per Minit 冲击数	0 - 3,200
No Load Speed (RPM) Kelajuan Tanpa Beban 回转数	0 - 3,600
Max Fastening Torque Maksimum Tenaga Pemutaran Pengancing 最快扭力	100N-m (74ft.lbs.)
Dimensions (L x W x H) Dimensi 体积	184x67x192mm (7-1/4"x2-5/8"x7-9/16")
Net weight Berat Bersih 净重	0.99kg (2.2lbs)
Power supply cord Kabel Wayar 电源线	2.5m (8.2ft)

FS2300

419

Drywall Screwdriver Pemutar Skru Drywall 石膏板螺丝起子机



- **Large trigger with lock-on button for operator convenience**
Butang pencetus dengan fungsi mengunci untuk memudahkan pengguna
备有锁定功能的触发按钮方便操作



Standard Equipment: Phillips Insert Bit x2, Magnetic Bit Holder



Continuous Rating Input Input Kuasa Berterusan 额定输入功率	570W
Capacity Kapasiti 能力	Drywall Screw: 5mm (3/16") Self-Drilling Screw: 6mm (1/4")
Driving Shank (Hex) Hex Memandu Aci 六角驱动轴	6.35mm (1/4")
No Load Speed (RPM) Kelajuan Tanpa Beban 回转数	0 - 2,500
Dimensions (L x W x H) Dimensi 体积	290x70x207mm (11-3/8"x2-3/4"x8-1/8")
Net Weight Berat Bersih 净重	1.6kg (3.5lbs)
Power Supply Cord Kabel Wayar 电源线	2.5m (8.2ft.)

FS2500

419

Screwdriver Pemutar Skru 螺丝起子机



- **Aluminum gear housing for less weight and increased durability**
Lebih tahan lama dan ringan dengan gear aluminium
铝合金齿轮更轻更耐用



Standard Equipment: Magnetic Socket Bit



Continuous Rating Input Input Kuasa Berterusan 额定输入功率	570W
Capacity Kapasiti 能力	Drywall Screw: 5mm (3/16") Self-Drilling Screw: 6mm (1/4")
Driving Shank (Hex) Hex Memandu Aci 六角驱动轴	6.35mm (1/4")
No Load Speed (RPM) Kelajuan Tanpa Beban 回转数	0 - 2,500
Dimensions (L x W x H) Dimensi 体积	280x70x207mm (11"x2-3/4"x8-1/8")
Net Weight Berat Bersih 净重	1.5kg (3.4lbs)
Power Supply Cord Kabel Wayar 电源线	2.5m (8.2ft.)

Cordless
Tutupi Rod (RUB)LED Flashlight
Lampu Skaah, LED
LED (RUB)Vacuum Cleaner
Penjamban Vakuum
VACUUMDrilling / Fastening
Gergaji / Pengisar
DRILL / FASTENImpact Drilling / Demolition
Gergaji / Pengisar
IMPACT DRILL / DEMOCutting
Pangkas
CUTTINGGrinding / Smoothing
Mergasi / Pucuk
GRINDING / SMOOTHSawing
Gergaji
SAWINGPlaning / Routing
Pangkas / Tunggul
PLANING / ROUTINGOthers
Lain-lain
OTHERSOutdoor Power Equipment
Alatan Penguji Luar
OUTDOOR POWER EQUIPMENTMakita
Makita

Drilling | Fastening

Cordless
Tahan Tanpa Kabel

LED Flashlight
Lampu Senter LED
1000mAh

Vacuum Cleaner
Pembersih Vakuum
BLUET

Drilling / Fastening
Drevel / Pasang
钻头 / 螺丝

Impact Drilling / Demolition
Drevel / Pasang
Drevel / Pasang
钻头 / 螺丝

Cutting
Pemotongan
Drevel / Pasang

Grinding / Sanding
Drevel / Pasang
Drevel / Pasang
Drevel / Pasang

Sawing
Drevel / Pasang
Drevel / Pasang

Planing / Routing
Drevel / Pasang
Drevel / Pasang

Others
Lain-lain
Drevel / Pasang

Outdoor Power Equipment
Alat-alat Tenaga Listrik
Drevel / Pasang

Makita
1911

FS2700

419 W

Screwdriver

Pemutar Skru
螺丝起子机



- 6 stage adjustable torque adjustment for a wide range of applications
- 6 tahap pelarasan tork untuk pelbagai aplikasi
- 6级扭力调节适合各种应用



Continuous Rating Input Input Kuasa Berterusan 额定输入功率	570W
Capacity Kapasiti 能力	Self-Drilling Screw: 6mm (1/4") Machine Screw: 8mm (5/16") Wood Screw: 6.2mm (1/4")
Driving Shank (Hex) Hex Memandu Aci 六角驱动轴	6.35mm (1/4")
No Load Speed (RPM) Kelajuan Tanpa Beban 回转速数	0 - 2,500
Dimensions (L x W x H) Dimensi 体积	301x70x207mm (11-7/8"x2-3/4"x8-1/8")
Net Weight Berat Bersih 净重	1.8kg (4lbs)
Power Supply Cord Kabel Wayar 电源线	2.5m (8.2ft.)

FS4200

419 W

Drywall Screwdriver

Pemutar Skru Papan Gypsum
石膏板螺丝起子机



- Powerful 570W motor
- Motor berkuasa 570W
- 570W强力马达

Standard Equipment: Phillips Insert Bit x2, Magnetic Bit Holder



Continuous Rating Input Input Kuasa Berterusan 额定输入功率	570W
Capacity Kapasiti 能力	Drywall Screw: 5mm (3/16") Self-Drilling Screw: 6mm (1/4") 6.35mm (1/4")
Driving Shank (Hex) Hex Memandu Aci 六角驱动轴	6.35mm (1/4")
No Load Speed (RPM) Kelajuan Tanpa Beban 回转速数	0 - 4,000
Dimensions (L x W x H) Dimensi 体积	269x65x207mm (10-5/8"x2-9/16"x8-1/8")
Net Weight Berat Bersih 净重	1.4kg (3lbs)
Power Supply Cord Kabel Wayar 电源线	2.5m (8.2ft.)

FS6300

419 W

Drywall Screwdriver

Pemutar Skru Papan Gypsum
石膏板螺丝起子机



- Silent clutch for improved performance and durability
- Klac senyap untuk prestasi dan ketahanan yang lebih baik
- 静音离合器提高性能和耐用性

Standard Equipment: Phillips Insert Bit x2, Magnetic Bit Holder



Continuous Rating Input Input Kuasa Berterusan 额定输入功率	570W
Capacity Kapasiti 能力	Drywall Screw: 4mm (5/32")
Driving Shank (Hex) Hex Memandu Aci 六角驱动轴	6.35mm (1/4")
No Load Speed (RPM) Kelajuan Tanpa Beban 回转速数	0 - 6,000
Dimensions (L x W x H) Dimensi 体积	279x65x207mm (11"x2-9/16"x8-1/8")
Net Weight Berat Bersih 净重	1.4kg (3.1lbs)
Power Supply Cord Kabel Wayar 电源线	2.5m (8.2ft.)



DRILLING | FASTENING

UT1305

303

Mixer

Pengadun
搅拌机



- Heavy duty and high speed mixer
Tahan lasak dan kelajuan tinggi
耐用和高速

Standard Equipment: Wrenches, Side Grip, Blade



Continuous Rating Input Input Kuasa Berterusan 额定输入功率	850W
Blade Diameter Diameter Bilah 锯片直径	165mm (6-1/2")
No Load Speed (RPM) Kelajuan Tanpa Beban 回转数	1,300
Shank Size of Tool Holder Portion Batang Saiz 柄部尺寸	M12
Dimensions (L x W x H) Dimensi 体积	942x87x152mm (37"x3-7/16"x6")
Net Weight Berat Bersih 净重	2.6kg (5.7lbs)
Power Supply Cord Kabel Wayar 电源线	2.5m (8.2ft)

UT2204

303

Mixer

Pengadun
搅拌机



- Heavy duty and high speed mixer
Tahan lasak dan kelajuan tinggi
耐用和高速

Standard Equipment: Wrenches, Side Grip



Continuous rating input Input Kuasa Berterusan 额定输入功率	850W
Blade Diameter Diameter Bilah 锯片直径	220mm (8-5/8")
No Load Speed (RPM) Kelajuan Tanpa Beban 回转数	550
Shank Size of Tool Holder Portion Batang Saiz 柄部尺寸	M12 or M14
Dimensions (L x W x H) Dimensi 体积	929x89x152mm (36-1/2"x3-1/2"x6")
Net weight Berat Bersih 净重	2.7kg (5.9lbs)
Power supply cord Kabel Wayar 电源线	2.5m (8.2ft)

TW1000 25.4mm (1")

153

Impact Wrench

Perengkuh Impak
套筒扳手



- Huge 1,000N-m (738 ft.lbs.) of Power for Industrial Applications
Kuasa 1,000N-m (738 ft.lbs.) untuk aplikasi perindustrian
巨大的 1,000N · m (738 ft.lbs.) 功率适合工业应用

Standard Equipment: Side Grip, Socket



Continuous Rating Input Input Kuasa Berterusan 额定输入功率	1,200W
Fastening Capacities Kapasiti 能力	Standard Bolt: M24 - M30 (15/16" - 1-3/16") High Tensile Bolt: M22 - M24 (7/8" - 15/16")
Square Drive Batang Segi Empat 四方头	25.4mm (1")
No Load Speed (RPM) Kelajuan Tanpa Beban 回转数	1,400
Impacts Per Minute (IPM) Impak Per Minit 冲击数	1,500
Max Fastening Torque Maksimum Tenaga Pemutaran Pengancing 最快扭力	1,000N-m (738ft.lbs.)
Dimensions (L x W x H) Dimensi 体积	382x110x290mm (15"x4-5/16"x11-3/8")
Net Weight Berat Bersih 净重	8.8kg (19.4lbs)
Power Supply Cord Kabel Wayar 电源线	2.5m (8.2ft)

6906 19mm (3/4")

100

Impact Wrench

Perengkuh Impak
套筒扳手



- Powerful 850W motor
Motor berkuasa 850W
强大的850W马达

Standard Equipment: Side Grip, Socket



Continuous Rating Input Input Kuasa Berterusan 额定输入功率	850W
Capacity Kapasiti 能力	Standard Bolt: M16 - M22 (5/8" - 7/8") High Tensile Bolt: M16 - M20 (5/8" - 3/4")
Square Drive Batang Segi Empat 四方头	19mm (3/4")
No Load Speed (RPM) Kelajuan Tanpa Beban 回转数	1,700
Impacts Per Minute (IPM) Impak Per Minit 冲击数	1,600
Max Fastening Torque Maksimum Tenaga Pemutaran Pengancing 最快扭力	588 N-m (441ft.lbs.)
Overall Length Dimensi 体积	327mm (12-7/8")
Net Weight Berat Bersih 净重	5.6kg (12.2lbs)
Power Supply Cord Kabel Wayar 电源线	2.5m (8.2ft)

6905B 12.7mm (1/2")

65

Impact Wrench

Perengkuh Impak
套筒扳手



- Aluminum hammer case with high durability
Casing aluminium yang bertahan
铝制外壳更耐用

Standard Equipment: Socket 19, 22, 24



Continuous Rating Input Input Kuasa Berterusan 额定输入功率	440W
Fastening Capacities Kapasiti 能力	Standard Bolt: M12 - M20 (1/2" - 3/4") High Tensile Bolt: M12 - M16 (1/2" - 5/8")
Square Drive Batang Segi Empat 四方头	12.7mm (1/2")
No Load Speed (RPM) Kelajuan Tanpa Beban 回转数	1,700
Impacts Per Minute (IPM) Impak Per Minit 冲击数	2,000
Max Fastening Torque Maksimum Tenaga Pemutaran Pengancing 最快扭力	294N-m (217ft.lbs.)
Overall Length Dimensi 体积	270mm (10-5/8")
Net Weight Berat Bersih 净重	2.8kg (6.2lbs)
Power Supply Cord Kabel Wayar 电源线	2.5m (8.2ft)

Cordless
Tutupi Rod (RUL)LED Flashlight
Lampu Saha, LED
(LED/SHFT)Vacuum Cleaner
Penjalinan Vakum
(VACU)Drilling / Fastening
Ganda / Pengancing
(DRILL / FASTEN)Impact Drilling / Demolition
Ganda / Pencah
(IMPACT / DEMO)Cutting
Pampasan
(CUT)Grinding / Smoothing
Pengira / Pucuk
(GRIND / SMOOTH)Sawing
Gajug
(SAW)Planing / Routing
Pengira / Tunggul
(PLAN / ROUTE)Others
Lain-lain
(OTHERS)Outdoor Power Equipment
Alatan Penguat Luar
(OPE)Makita
Makita

Drilling | Fastening

TW0350 12.7mm (1/2")

411 WATT

Impact Wrench Perengkuh Impak 套筒扳手



- **Large, efficient hammer creates more impacts for greater power**
Penukuk kecekapan tinggi untuk hentaman yang lebih kuat
高效率锤子给予更强的冲击力

Standard Equipment: Socket



Continuous Rating Input Input Kuasa Berterusan 额定输入功率	400W
Fastening Capacities Kapasiti 能力	Standard Bolt: M12 - M22 (1/2" - 7/8") High Tensile Bolt: M12 - M16 (1/2" - 5/8") 12.7mm (1/2")
Square Drive Batang Segi Empat 四方头	
No Load Speed (RPM) Kelajuan Tanpa Beban 回转数	2,000
Impacts Per Minute (IPM) Impak Per Minit 冲击数	2,000
Max Fastening Torque Maksimum Tenaga Pemutaran Pengancing 最快扭力	350N-m (260ft.lbs.)
Dimensions (L x W x H) Dimensi 体积	283x87x233mm (11-1/8"x3-7/16"x9-1/8")
Net Weight Berat Bersih 淨重	3kg (6.6lbs)
Power Supply Cord Kabel Wayar 电源线	2.5m (8.2ft)

TW0200 12.7mm (1/2")

411 WATT

Impact Wrench Perengkuh Impak 套筒扳手



- **Compact and lightweight design for use in tight spaces**
Sesuai untuk digunakan di ruang kecil
方便用于小空间

Standard Equipment: Socket, Hook



Continuous Rating Input Input Kuasa Berterusan 额定输入功率	380W
Fastening Capacities Kapasiti 能力	Standard Bolt: M10 - M16 (3/8" - 5/8") High Tensile Bolt: M10 - M12 (3/8" - 1/2") 12.7mm (1/2")
Square Drive Batang Segi Empat 四方头	
No Load Speed (RPM) Kelajuan Tanpa Beban 回转数	0 - 2,200
Impacts Per Minute (IPM) Impak Per Minit 冲击数	0 - 2,200
Max Fastening Torque Maksimum Tenaga Pemutaran Pengancing 最快扭力	200N-m (150ft.lbs.)
Dimensions (L x W x H) Dimensi 体积	251x72x220mm (9-7/8"x2-13/16"x8-5/8")
Net Weight Berat Bersih 淨重	2.1kg (4.7lbs)
Power Supply Cord Kabel Wayar 电源线	2.5m (8.2ft)

6922NB M16 (5/8"), M20 (3/4"), M22 (7/8")

411 WATT

Shear Wrench Perengkuh Ricih 扭断式套筒扳手



- **Compact and Lightweight Yet Powerful**
Kompak dan ringan namun berkuasa
小巧轻便功能强大

Standard Equipment: Screwdriver, Sleeve M20, Sleeve M22



Continuous Rating Input Input Kuasa Berterusan 额定输入功率	1,330W
Capacity Kapasiti 能力	Bolt : M16, M20, M22 (5/8", 3/4", 7/8") 18
No Load Speed (RPM) Kelajuan Tanpa Beban 回转数	18
Max Fastening Torque Maksimum Tenaga Pemutaran Pengancing 最快扭力	804N-m (593ft.lbs.)
Dimensions (L x W x H) Dimensi 体积	249x84x252mm (9-13/16"x3-5/16"x9-15/16")
Net Weight Berat Bersih 淨重	4.9kg (10.8lbs)
Power Supply Cord Kabel Wayar 电源线	2.5m (8.2ft)

6924N M22 (7/8"), M24 (1"), SHTB22

303 WATT

Shear Wrench Perengkuh Ricih 扭断式套筒扳手



- **High rotational speed for more efficient operation**
Kelajuan putaran tinggi untuk operasi yang lebih cekap
高转速提高操作效率

Standard Equipment: Screwdriver, Sleeve M24



Continuous Rating Input Input Kuasa Berterusan 额定输入功率	1,050W
Capacity Kapasiti 能力	Bolt : M22, M24, 7/8", 1" Super high tensile bolt : M22 19
No Load Speed (RPM) Kelajuan Tanpa Beban 回转数	19
Max Fastening Torque Maksimum Tenaga Pemutaran Pengancing 最快扭力	1,100N-m (810ft.lbs.)
Dimensions (L x W x H) Dimensi 体积	330x104x257mm (13"x4-1/8"x10-1/8")
Net Weight Berat Bersih 淨重	7.5kg (16.6lbs)
Power Supply Cord Kabel Wayar 电源线	2.5m (8.2ft)

HB500 50mm (2")

Magnetic Drill Gerudi Magnet 磁力钻孔机



- **Magnetic base, drill stand, and drill machine all in one package system**
Dasar bermagnet, mesin dan penagak gerudi dalam satu sistem
磁性底座, 钻架和钻机集在同一系统

Standard Equipment: Quick release arbor, Small oil cup assembly and clip, Safety guard, Polyester safety strap, Integral oil feed steady allen keys



Capacity Kapasiti 能力	Steel: 50mm (2")
Chuck Capacity Kapasiti Chuck 夹头能力	16mm (5/8")
No Load Speed (RPM) Kelajuan Tanpa Beban 回转数	350 / 650
Magnetic Clamping Force Kekuatan Penjepit Magnetik 磁力夹紧力	Minimum 9,300N (950kg)
Dimensions (L x W x H) Dimensi 体积	290x150x450mm (11-3/8"x5-7/8"x17-3/4")
Net Weight Berat Bersih 淨重	18.5kg (40.8lbs)

IMPACT DRILLING DEMOLITION

Gerudi | Pemecah 石工钻孔 | 凿裂加工



HP0300 10mm (3/8")

411

Hammer Driver Drill
Tukul Pemutar Skru Bergerudi
冲击螺丝起子电钻

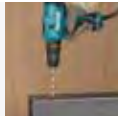

- 2-mode operation for "Rotation Only" or "Hammering with Rotation"
operasi 2 mod, penukulan dengan putaran atau hanya putaran
2档模式变换, 旋转并锤击或仅旋转



Standard Equipment: (+)(-) Bit



Continuous Rating Input Input Kuasa Berterusan 额定输入功率	320W
Capacity Kapasiti 能力	Concrete: 8mm (5/16") Steel: 10mm (3/8") Wood: 28mm (1-1/8")
Chuck Capacity Kapasiti Chuck 夹头能力	1.0 - 10mm (1/32 - 3/8")
Impacts Per Minute (IPM) Impak Per Minit 冲击数	High: 0 - 22,500 Low: 0 - 6,750
No Load Speed (RPM) Kelajuan Tanpa Beban 回转速数	High: 0 - 1,500 Low: 0 - 450
Max Fastening Torque Tenaga Pemutaran Pengancing Maksimum 最快扭转	Hard 56.0N-m (500in.lbs.) Soft: 21.0N-m (190in.lbs.)
Max Lock Torque Pemutaran Tenaga Maksimum 最大锁定扭力	42.0N-m (370in.lbs.)
Dimensions (L x W x H) Dimensi 体积	235x67x206mm (9-1/4"x2-5/8"x8-1/8")
Net Weight Berat Bersih 净重	1.3kg (2.8lbs.)
Power Supply Cord Kabel Wayar 电源线	2.5m (8.2ft)

HP1230 12mm (15/32")

419

Hammer Drill
Gerudi Tukul
冲击电钻



- 2 operation modes - hammering with rotation and rotation only
Operasi 2-Mod untuk Putaran Hanya atau Hammering with Rotation
仅旋转或旋转锤击的双模式操作



Standard Equipment: Chuck Key, Depth Gauge, Side Grip



Continuous Rating Input Input Kuasa Berterusan 额定输入功率	400W
Capacity Kapasiti 能力	Concrete: 12mm (15/32")/ Steel: 10mm (3/8")/ Wood: 15mm (9/16")
Chuck Capacity Kapasiti Chuck 夹头能力	1.5 - 10mm (1/16 - 3/8")
Impacts Per Minute (IPM) Impak Per Minit 冲击数	0 - 31,900
No Load Speed (RPM) Kelajuan Tanpa Beban 回转速数	0 - 2,900
Dimensions (L x W x H) Dimensi 体积	239x67x188mm (9-3/8"x2-5/8"x7-3/8")
Net Weight Berat Bersih 净重	1.7kg (3.7lbs.)
Power Supply Cord Kabel Wayar 电源线	2.0m (6.6ft)

HP1630 16mm (5/8")

85

Hammer Drill
Gerudi Tukul
冲击电钻



- Lightweight with large drilling capacity up to 16mm in concrete
Ringan dengan kapasiti penggerudian yang besar sehingga 16mm dalam konkrit
轻量, 高能力, 混凝土钻孔达16mm



Standard Equipment: Side Handle, Chuck Key



Continuous Rating Input Input Kuasa Berterusan 额定输入功率	710W
Capacity Kapasiti 能力	Concrete: 16mm (5/8")/ Steel: 13mm (1/2")/ Wood: 30mm (1-3/16")
No Load Speed (RPM) Kelajuan Tanpa Beban 回转速数	0 - 3,200
Impacts Per Minute (IPM) Impak Per Minit 冲击数	0 - 48,000
Dimensions (L x W x H) Dimensi 体积	296x75x204mm (11-5/8"x2-15/16"x8")
Net Weight Berat Bersih 净重	2.1kg (4.6lbs)
Power Supply Cord Kabel Wayar 电源线	2.0m (6.6ft)

Cordless
Tidak Perlu Kabel

LED Flashlight
Lampu Senter LED
- LED 3000 BRIGHT

Vacuum Cleaner
Penyedut Debu
- 2.5L

Drilling | Fastening
Gasing | Pengancing
- 1/2" | 3/8"

Impact Drilling | Demolition
Gasing Pemecah
- 1/2" | 3/8"

Cutting
Pemotongan
- 1/2"

Grinding | Sanding
Moyul | Pasir
- 1/2"

Sawing
Gasing
- 1/2"

Planing | Routing
Pogolan | Tengking
- 1/2"

Others
Lain-lain
- 1/2"

Outdoor Power Equipment
Alat Perkakas Luar
- 1/2"

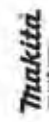

IMPACT DRILLING | DEMOLITION

HP2050 20mm (3/4")

419 W

2-Speed Hammer Drill

Gerudi Tukul
冲击电钻



- **2-Mode operation for Rotation Only or Hammering with Rotation**
Operasi 2-Mod untuk Putaran Hanya atau Hammering with Rotation
仅旋转或旋转锤击的双模式操作

Standard Equipment: Chuck Key, Side Grip, Depth Rod



Continuous Rating Input Input Kuasa Berterusan 额定输入功率	720W
Capacity Kapasiti 能力	Concrete: 20mm (3/4")
	Steel Hi : 8mm (5/16") Steel Lo : 13mm (1/2") Wood Hi : 25mm (1") Wood Lo : 40mm (1-9/16")
Impacts Per Minute (IPM) Kelajuan Tanpa Beban 回转数	High: 0-58,000 Low: 0-24,000
No Load Speed (RPM) Impak Per Minit 冲击数	High: 0-2,900 Low: 0-1,200
Overall Length Panjang Keseluruhan 总长度	362mm (14-1/4")
Net Weight Berat Bersih 净重	2.5kg (5.6lbs)
Power Supply Cord Kabel Wayar 电源线	2.5m (8.2ft)

HR1830 18mm (11/16")

419 W

Rotary Hammer

Tukul Putar
电锤



- **2-Mode operation for Rotation Only or Hammering with Rotation**
Operasi 2-Mod untuk Putaran Hanya atau Hammering with Rotation
仅旋转或旋转锤击的双模式操作

Standard Equipment: Side Grip, Depth Gauge



Continuous Rating Input Input Kuasa Berterusan 额定输入功率	440W
Impact Energy Kekuatan Impak 单次最大锤击力	EPTA-Procedure 05/2009: 1.2J Our experimental conditions: 1.2J
Capacity Kapasiti 能力	Concrete: 18mm (11/16")/ Concrete (Diamond core bit) : 65mm (2-9/16")/ Steel: 13mm (1/2")/ Wood: 24mm (15/16")
Impacts Per Minute (IPM) Impak Per Minit 冲击数	0-5,000
No Load Speed (RPM) Kelajuan Tanpa Beban 回转数	0-1,500
Dimensions (L x W x H) Dimensi 体积	279x66x208mm (10-7/8"x2-5/8"x8-3/16")
Net Weight Berat Bersih 净重	1.9kg (4.2lbs)
Power Supply Cord Kabel Wayar 电源线	2.5m (8.2ft)

HR1840 18mm (11/16")

459 W

Rotary Hammer

Tukul Putar
电锤



- **2-Mode operation for Rotation Only or Hammering with Rotation**
Operasi 2-Mod untuk Putaran Hanya atau Hammering with Rotation
仅旋转或旋转锤击的双模式操作

Standard Equipment: Side Grip, Depth Gauge



Continuous Rating Input Input Kuasa Berterusan 额定输入功率	470W
Impact Energy Kekuatan Impak 单次最大锤击力	EPTA-Procedure 05/2009: 1.4J Our experimental conditions: 1.4J
Capacity Kapasiti 能力	Concrete: 18mm (11/16")/ Core Bit: 35mm (1-3/8")/ Diamond Core Bit (Dry Type): 65mm (2-9/16")/ Steel: 13mm (1/2") Wood: 24mm (15/16")
Impacts Per Minute (IPM) Impak Per Minit 冲击数	0 - 4,800
No Load Speed (RPM) Kelajuan Tanpa Beban 回转数	0 - 2,100
Dimensions (L x W x H) Dimensi 体积	285x75x208mm (11-1/4"x3"x8-3/16")
Net Weight Berat Bersih 净重	2.0 - 2.4kg (4.3 - 5.3lbs)
Power Supply Cord Kabel Wayar 电源线	2.5m (8.2ft)

HR1841F 18mm (11/16")

459 W

Rotary Hammer

Tukul Putar
电锤

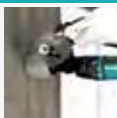

- **2 operation modes - "Hammering with Rotation" and "Rotation" only**
2 mod operasi - "Mengetuk dengan Putaran" dan "Putaran" sahaja
2种操作模式 - "旋转锤击" 和 "旋转"

Standard Equipment: Side Grip, Depth Gauge



Continuous Rating Input Input Kuasa Berterusan 额定输入功率	470W
Impact Energy Kekuatan Impak 单次最大锤击力	EPTA-Procedure 05/2009: 1.4J Our experimental conditions: 1.4J
Capacity Kapasiti 能力	Concrete: 18mm (11/16")/ Core Bit: 35mm (1-3/8")/ Diamond Core Bit (Dry Type): 65mm (2-9/16")/ Steel: 13mm (1/2") Wood: 24mm (15/16")
Impacts Per Minute (IPM) Impak Per Minit 冲击数	0 - 4,800
No Load Speed (RPM) Kelajuan Tanpa Beban 回转数	0 - 2,100
Dimensions (L x W x H) Dimensi 体积	285x75x208mm (11-1/4"x3"x8-3/16")
Net Weight Berat Bersih 净重	2.0 - 2.5kg (4.5 - 5.4lbs)
Power Supply Cord Kabel Wayar 电源线	2.5m (8.2ft)

HR2020 20mm (3/4")

419 W

Rotary Hammer

Tukul Putar
电锤



- **2-Mode operation for Rotation Only or Hammering with Rotation**
Operasi 2-Mod untuk hanya putaran, penukulan dengan putaran sahaja
仅旋转或旋转锤击的双模式操作

Standard Equipment: Side Grip, Depth Gauge



Continuous Rating Input Input Kuasa Berterusan 额定输入功率	710W
Capacity Kapasiti 能力	Concrete: 20mm (3/4")/ Steel: 13mm (1/2") Wood: 32mm (1-1/4")
Impacts Per Minute (IPM) Impak Per Minit 冲击数	0 - 4,050
No Load Speed (RPM) Kelajuan Tanpa Beban 回转数	0 - 1,050
Overall Length Panjang Keseluruhan 总长度	352mm (13-7/8")
Net Weight Berat Bersih 净重	2.3kg (5.1lbs)
Power Supply Cord Kabel Wayar 电源线	4.0m (13.1ft)

Cordless
Tanpa Kabel / 无线

LED Flashlight
Lampu Senter LED / LED 手电筒

Vacuum Cleaner
Penyedut Debu / 吸尘器

Drilling / Fastening
Dinding / Pasang / 钻孔 / 固定

Impact Drilling / Demolition
Dinding / Pasang / 钻孔 / 固定 / 冲击钻孔 / 拆除

Cutting / Perataan
Dinding / 切割 / 平整

Grinding / Sanding
Dinding / 打磨 / 磨光

Sawing / Potong
Dinding / 切割 / 锯

Planing / Routing
Dinding / 刨平 / 开槽

Others
Lain-lain / 其他

Outdoor Power Equipment
Alat Berdaya Luar / 户外动力设备

Makita
Makita

IMPACT DRILLING | DEMOLITION

HR2320T / X2 23mm (7/8")

325 WATT

Combination Hammer
Tukul Kombinasi
电冲击钻锤



- **3-Mode operation; rotation only, hammering with rotation and hammering only**
operasi 3 mod: hanya putaran, penukulan dengan putaran, penukulan sahaja
3档模式变换: 仅旋转, 旋转并锤击, 仅锤击

Standard Equipment:
HR2320T: Side Handle, Depth Gauge, Quick Change Drill Chuck (194079-2)
HR2320TX2: Side Handle, Depth Gauge, Quick Change Drill Chuck (194079-2), SDS-Plus Drill & Chisel Set (D-46361)

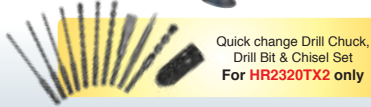

Continuous Rating Input Input Kuasa Berterusan 额定输入功率	720W
Impact Energy Kekuatan Impak 单次最大冲击力	EPTA-Procedure 05/2009: 2.3J Our experimental conditions: 2.6J
Capacity Kapasiti 能力	Concrete: 23mm (7/8")/ Steel: 13mm (1/2")/ Wood: 32mm (1-1/4")
Impacts Per Minute (IPM) Impak Per Minit 冲击数	0 - 4,600
No Load Speed (RPM) Kelajuan Tanpa Beban 回转数	0 - 1,200
Dimensions (L x W x H) Dimensi 体积	380x77x209mm (15"x3"x8-1/4")
Net Weight Berat Bersih 净重	2.9 - 3.2kg (6.4 - 7.0 lbs)
Power Supply Cord Kabel Wayar 电源线	2.5m (8.2 ft)

HR2470X5 24mm (15/16")

325 WATT

Combination Hammer
Tukul Kombinasi
电冲击钻锤



- **3-Mode operation; rotation only, hammering with rotation and hammering only**
operasi 3 mod: hanya putaran, penukulan dengan putaran, penukulan sahaja
3档模式变换: 仅旋转, 旋转并锤击, 仅锤击

Standard Equipment: Side Handle, Depth Gauge, Drill Chuck (194041-7), SDS-Plus Bit Set (D-17784), Bull Point (D-08713)



Continuous Rating Input Input Kuasa Berterusan 额定输入功率	780W
Impact Energy Kekuatan Impak 单次最大冲击力	EPTA-Procedure 05/2009: 2.4J Our experimental conditions: 2.7J
Capacity Kapasiti 能力	Concrete: 24mm (15/16")/ Core Bit: 54mm (2-1/8")/ Steel: 13mm (1/2")/ Wood: 32mm (1-1/4")
Impacts Per Minute (IPM) Impak Per Minit 冲击数	0 - 4,500
No Load Speed (RPM) Kelajuan Tanpa Beban 回转数	0 - 1,100
Dimensions (L x W x H) Dimensi 体积	370x84x214mm (14-1/2"x3-5/16"x8-3/8")
Net Weight Berat Bersih 净重	2.9 - 3.3kg (6.4 - 7.3lbs)
Power Supply Cord Kabel Wayar 电源线	4.0m (13.1ft)

HR2631FTX2 26mm (1")

325 WATT

Combination Hammer
Tukul Kombinasi
电冲击钻锤



- **3-Mode operation; rotation only, hammering with rotation and hammering only**
operasi 3 mod: hanya putaran, penukulan dengan putaran, penukulan sahaja
3档模式变换: 仅旋转, 旋转并锤击, 仅锤击

Standard Equipment: Side Handle, Depth Gauge, Quick Change Drill Chuck, SDS-Plus Drill & Chisel Set

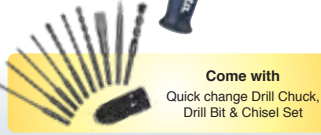

Continuous Rating Input Input Kuasa Berterusan 额定输入功率	800W
Impact Energy Kekuatan Impak 单次最大冲击力	EPTA-Procedure 05/2009: 2.4J Our experimental conditions: 2.9J
Capacity Kapasiti 能力	Concrete: 26mm (1")/ Core Bit: 68mm (2-11/16")/ Diamond Core Bit (Dry Type): 80mm (3-1/8")/ Steel: 13mm (1/2")/ Wood: 32mm (1-1/4")
Impacts Per Minute (IPM) Impak Per Minit 冲击数	0 - 4,600
No Load Speed (RPM) Kelajuan Tanpa Beban 回转数	0 - 1,200
Dimensions (L x W x H) Dimensi 体积	385x77x209mm (15-1/8"x3"x8-1/4")
Net Weight Berat Bersih 净重	3.1 - 3.6kg (6.8 - 7.9lbs)
Power Supply Cord Kabel Wayar 电源线	2.5m (8.2ft)

HR2611FT 26mm (1")

325 WATT

Combination Hammer
Tukul Kombinasi
电冲击钻锤



- **Extremely low vibration achieved by Anti-Vibration Technology**
Getaran rendah dengan Teknologi anti-getaran AVT
AVT防震技术降低振动

Standard Equipment: Side Grip, Depth Gauge, Quick Change Drill Chuck

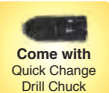

Continuous Rating Input Input Kuasa Berterusan 额定输入功率	800W
Impact Energy Kekuatan Impak 单次最大冲击力	2.4J
Capacity Kapasiti 能力	Concrete: 26mm (1")/ Steel: 13mm (1/2")/ Wood: 32mm (1-1/4")
Impacts Per Minute (IPM) Impak Per Minit 冲击数	0-4,600
No Load Speed (RPM) Kelajuan Tanpa Beban 回转数	0-1,200
Dimensions (L x W x H) Dimensi 体积	385x77x209mm (15-1/8"x3"x8-1/4")
Net Weight Berat Bersih 净重	3.0kg (6.6lbs)
Power Supply Cord Kabel Wayar 电源线	2.5m (8.2ft)

HR2630X3 26mm (1")

325 WATT

Combination Hammer
Tukul Kombinasi
电冲击钻锤



- **3-Mode operation; rotation only, hammering with rotation and hammering only**
operasi 3 mod: hanya putaran, penukulan dengan putaran, penukulan sahaja
3档模式变换: 仅旋转, 旋转并锤击, 仅锤击

Standard Equipment: Side Handle, Depth Gauge, Drill Chuck, SDS-Plus Drill & Chisel Set

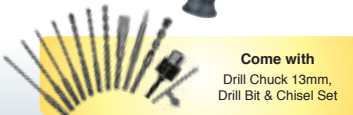

Continuous Rating Input Input Kuasa Berterusan 额定输入功率	800W
Impact Energy Kekuatan Impak 单次最大冲击力	EPTA-Procedure 05/2009: 2.4J Our experimental conditions: 2.9J
Capacity Kapasiti 能力	Concrete: 26mm (1")/ Core Bit: 68mm (2-11/16")/ Diamond Core Bit (Dry Type): 80mm (3-1/8")/ Steel: 13mm (1/2")/ Wood: 32mm (1-1/4")
Impacts Per Minute (IPM) Impak Per Minit 冲击数	0 - 4,600
No Load Speed (RPM) Kelajuan Tanpa Beban 回转数	0 - 1,200
Dimensions (L x W x H) Dimensi 体积	385x77x209mm (15-1/8"x3"x8-1/4")
Net Weight Berat Bersih 净重	2.8 - 3.3kg (6.3 - 7.2lbs)
Power Supply Cord Kabel Wayar 电源线	2.5m (8.2ft)

Cordless
LED Flashlight
Vacuum Cleaner
Drilling / Fastening
Impact Drilling / Demolition
Cutting / Grinding
Grinding / Sanding
Sawing / Demolition
Planing / Routing
Others
Outdoor Power Equipment



IMPACT DRILLING | DEMOLITION

Large Fan Provides Incredibly High Dust Extraction Power

Kipas besar untuk kuasa ekstraksi habuk yang sangat tinggi
大风扇提供令人难以置信的高除尘能力



65 mm

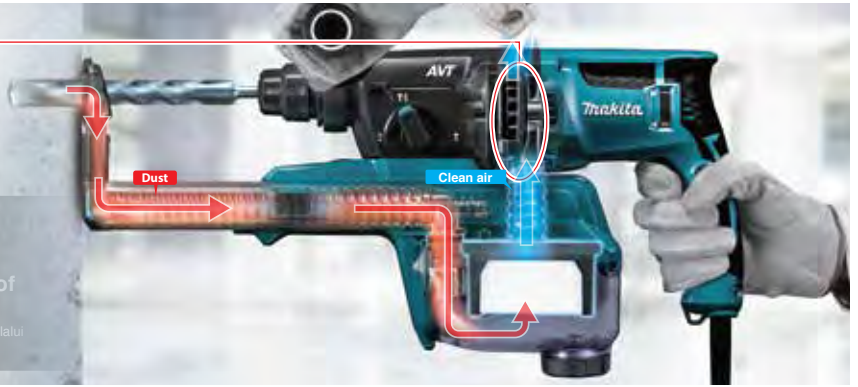

Equipped with HEPA Filter

Dilengkapi dengan Penapis HEPA 配备 HEPA 过滤器

which removes particles with an efficiency rating of 99.75% from the air passing through

yang menghilangkan zarah dengan penarafan kecekapan 99.75% dari udara yang melalui
从通过的空气中去除效率等级为99.75%的颗粒

HR2652 26mm (1")

325 W

Combination Hammer with Self Dust Collection

Tukul Kombinasi dengan Sistem Pengumpulan Habuk
电冲击钻锤与集尘系统



• See-through dust case for easy checking of collected dust amount

Tahap pengumpulan habuk mudah dilihat dengan kotak habuk lutsinar
透视集尘盒方便检查集尘量



Standard Equipment: Side Grip, Depth Gauge, Sealing Cap



Continuous Rating Input

800W

Input Kuasa Berterusan 额定输入功率

Impact Energy

Kekuatan Impak 单次最大锤击力

EPTA-Procedure 05/2009: 2.2J

Our experimental conditions: 2.9J

Capacity

Kapasiti 能力

Concrete: 26mm (1")
Core Bit: 68mm (2-11/16")
Diamond Core Bit: 80mm (3-1/8")
Steel: 13mm (1/2") Wood: 32mm (1-1/4")

Impacts Per Minute (IPM)

Impak Per Minit 冲击数

0 - 4,600

No Load Speed (RPM)

Kelajuan Tanpa Beban 回转数

0 - 1,200

Dimensions (L x W x H)

Dimensi 体积

604x89x260mm
(23-3/4"x3-1/2"x10-1/4")

Net Weight

Berat Bersih 净重

3 - 4.3kg (6.7 - 9.4lbs.)

Power Supply Cord

Kabel Wayar 电源线

2.5m (8.2ft.)

HR2810 28mm (1-1/8")

325 W

Combination Hammer

Tukul Kombinasi
电冲击钻锤



• 3-Mode operation; rotation only, hammering with rotation and hammering only

operasi 3 mod: hanya putaran, penukulan dengan putaran, penukulan sahaja
3档模式变换: 仅旋转, 旋转并锤击, 仅锤击



Standard Equipment: Depth Gauge, Side Grip



Continuous Rating Input

800W

Input Kuasa Berterusan 额定输入功率

Impact Energy

Kekuatan Impak 单次最大锤击力

EPTA-Procedure 05/2009: 2.8J

Our experimental conditions: 2.9J

Capacity

Kapasiti 能力

Concrete (T.C.T. bit): 28mm (1-1/8")
Steel: 13mm (1/2") Wood: 32mm (1-1/4")

Impacts Per Minute (IPM)

Impak Per Minit 冲击数

0 - 4,500

No Load Speed (RPM)

Kelajuan Tanpa Beban 回转数

0 - 1,100

Dimensions (L x W x H)

Dimensi 体积

314x89x225mm
(12-3/8"x3-1/2"x8-7/8")

Net Weight

Berat Bersih 净重

3.4 - 3.8kg (7.5 - 8.5lbs)

Power Supply Cord

Kabel Wayar 电源线

2.5m (8.2ft.)

HR3011FCJ 30mm (1-3/16")

350 W

Combination Hammer

Tukul Kombinasi
电冲击钻锤



• 3-mode operation for "Rotation Only", "Hammering with Rotation" or "Hammering Only"

operasi 3 mod: hanya putaran, penukulan dengan putaran, penukulan sahaja
3档模式变换: 仅旋转, 旋转并锤击, 仅锤击



Standard Equipment: Depth Gauge, Side Grip



Impact Energy

Kekuatan Impak 单次最大锤击力

EPTA-Procedure 05/2009: 3.9J

Our experimental conditions: 4.5J

Capacity

Kapasiti 能力

Concrete (Core Bit): 80mm (3-1/8")
Concrete (Diamond Core Bit): 80mm (3-1/8")
Concrete (TCT Bit): 30mm (1-3/16")
Steel: 13mm (1/2")
Wood: 32mm (1-1/4")

Impacts Per Minute (IPM)

Impak Per Minit 冲击数

0 - 4500

Dimensions (L x W x H)

Dimensi 体积

369x98x242mm
(14-1/2"x3-7/8"x9-1/2")

Net Weight

Berat Bersih 净重

4.4 - 4.8kg (9.7 - 10.6lbs.)

Power Supply Cord

Kabel Wayar 电源线

4.0m (13.1ft)

HR3001CJ 30mm (1-3/16")

350 W

Combination Hammer

Tukul Kombinasi
电冲击钻锤



• 3-mode operation for "Rotation Only", "Hammering with Rotation" or "Hammering Only"

operasi 3 mod: hanya putaran, penukulan dengan putaran, penukulan sahaja
3档模式变换: 仅旋转, 旋转并锤击, 仅锤击



Standard Equipment: Depth Gauge, Side Grip



Impact Energy

Kekuatan Impak 单次最大锤击力

EPTA-Procedure 05/2009: 3.9J

Our experimental conditions: 4.5J

Capacity

Kapasiti 能力

Concrete (Core Bit): 80mm (3-1/8")
Concrete (Diamond Core Bit): 80mm (3-1/8")
Concrete (TCT Bit): 30mm (1-3/16")
Steel: 13mm (1/2")
Wood: 32mm (1-1/4")

Impacts Per Minute (IPM)

Impak Per Minit 冲击数

0 - 4500

Dimensions (L x W x H)

Dimensi 体积

369x98x226mm
(14-1/2" x 3-7/8" x 8-7/8")

Net Weight

Berat Bersih 净重

4.1 - 4.5kg (9.0 - 9.9lbs.)

Power Supply Cord

Kabel Wayar 电源线

4.0m (13.1ft)

Cordless
Lampu Sorot LED
Vacuum Cleaner
Drilling / Fastening
Impact Drilling / Demolition
Cutting / Pushing
Grinding / Sanding
Routing / Trimming
Others
Outdoor Power Equipment



IMPACT DRILLING | DEMOLITION

HR3210C 32mm (1-1/4")

350 W

Combination Hammer

Tukul Kombinasi
电冲击钻锤



- 3-Mode operation; rotation only, hammering with rotation and hammering only
operasi 3 mod: hanya putaran, penukulan dengan putaran, penukulan sahaja
3档模式变换: 仅旋转, 旋转并锤击, 仅锤击

Standard Equipment: Depth Gauge, Side Grip, Grease vessel

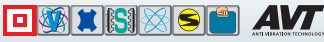

Continuous Rating Input Input Kuasa Berterusan 额定输入功率	850W
Impact Energy Kekuatan Impak 单次最大锤击力	EPTA-Procedure 05/2009: 5J Our experimental conditions: 5.5J
Capacity Kapasiti 能力	Concrete (T.C.T. bit) : 32mm (1-1/4")/ Steel: 13mm (1/2")/ Wood: 32mm (1-1/4")/ Concrete (Core bit) : 90mm (3-1/2")
Impacts Per Minute (IPM) Impak Per Minit 冲击数	1,650 - 3,300
No Load Speed (RPM) Kelajuan Tanpa Beban 回转数	315 - 630
Dimensions (L x W x H) Dimensi 体积	398x114x239mm (15-5/8"x4-1/2"x9-3/8")
Net Weight Berat Bersih 净重	5.2 - 5.6kg (11.4 - 12.4lbs)
Power Supply Cord Kabel Wayar 电源线	5.0m (16.4ft)

HR3200C 32mm (1-1/4")

350 W

Combination Hammer

Tukul Kombinasi
冲击电钻电锤



- 3-Mode operation; rotation only, hammering with rotation and hammering only
operasi 3 mod: hanya putaran, penukulan dengan putaran, penukulan sahaja
3档模式变换: 仅旋转, 旋转并锤击, 仅锤击

Standard Equipment: Depth Gauge, Side Grip, Grease Vessel (181573-3)



Continuous Rating Input Input Kuasa Berterusan 额定输入功率	850W
Impact Energy Kekuatan Impak 单次最大锤击力	EPTA-Procedure 05/2009: 5.1J Our experimental conditions: 5.5J
Capacity Kapasiti 能力	Concrete (T.C.T. bit) : 32mm (1-1/4")/ Steel: 13mm (1/2")/ Wood: 32mm (1-1/4")
Impacts Per Minute (IPM) Impak Per Minit 冲击数	1,650 - 3,300
No Load Speed (RPM) Kelajuan Tanpa Beban 回转数	315 - 630
Dimensions (L x W x H) Dimensi 体积	398x108x239mm (15-5/8"x4-1/4"x9-3/8")
Net Weight Berat Bersih 净重	4.8 - 5.2kg (10.5 - 11.5lbs)
Power Supply Cord Kabel Wayar 电源线	5.0m (16.4ft)

HR3530 35mm (1-3/8")

350 W

Rotary Hammer

Tukul Putar
电锤



- Compact and lightweight design
Kompak dan ringan
小巧轻便

Standard Equipment: Side Grip, Depth Gauge



Continuous Rating Input Input Kuasa Berterusan 额定输入功率	1,010W
Impact Energy Kekuatan Impak 单次最大锤击力	Our experimental conditions: 6.2J
Capacity Kapasiti 能力	Concrete (T.C.T. bit) : 35mm (1-3/8")/ Concrete (Core bit) : 105mm (4-1/8")
Impacts Per Minute (IPM) Impak Per Minit 冲击数	3,100
No Load Speed (RPM) Kelajuan Tanpa Beban 回转数	760
Dimensions (L x W x H) Dimensi 体积	374x100x243mm (14-3/4"x3-15/16"x9-9/16")
Net Weight Berat Bersih 净重	5.8kg (12.8lbs)
Power Supply Cord Kabel Wayar 电源线	5.0m (16.4ft)

HR4001C 40mm (1-9/16")

350 W

Rotary Hammer

Tukul Putar
电锤



- 2-Mode operation for Rotation with Hammering or Hammering only
Operasi 2-Mod untuk penukulan dengan putaran, penukulan sahaja
仅锤击或旋转锤击的双模式操作

Standard Equipment: Depth Gauge, Side Grip, Grease vessel



Continuous Rating Input Input Kuasa Berterusan 额定输入功率	1,100W
Impact Energy Kekuatan Impak 单次最大锤击力	EPTA-Procedure 05/2009: 6.8J Our experimental conditions: 9.5J
Capacity Kapasiti 能力	Concrete (T.C.T. bit) : 40mm (1-9/16")/ Concrete (Core bit) : 105mm (4-1/8")
Impacts Per Minute (IPM) Impak Per Minit 冲击数	1,350-2,750
No Load Speed (RPM) Kelajuan Tanpa Beban 回转数	235-480
Dimensions (L x W x H) Dimensi 体积	468x106x261mm (18-1/2"x4-3/16"x10-1/4")
Net Weight Berat Bersih 净重	5.9kg (13.0lbs)
Power Supply Cord Kabel Wayar 电源线	5.0m (16.4ft)

HR4002 40mm (1-9/16")

350 W

Rotary Hammer

Tukul Putar
电锤



- 2-Mode operation for Rotation with Hammering or Hammering only
Operasi 2-Mod untuk penukulan dengan putaran, penukulan sahaja
仅锤击或旋转锤击的双模式操作

Standard Equipment: Side Grip, Bit Grease, Depth Gauge



Continuous Rating Input Input Kuasa Berterusan 额定输入功率	1,050W
Impact Energy Kekuatan Impak 单次最大锤击力	EPTA-Procedure 05/2009: 6.1J Our experimental conditions: 6.2J
Capacity Kapasiti 能力	Concrete (T.C.T. bit) : 40mm (1-9/16")/ Concrete (Core bit) : 105mm (4-1/8")
Impacts Per Minute (IPM) Impak Per Minit 冲击数	2,500
No Load Speed (RPM) Kelajuan Tanpa Beban 回转数	680
Dimensions (L x W x H) Dimensi 体积	458x114x256mm (18"x4-1/2"x10-1/8")
Net Weight Berat Bersih 净重	6.6 - 6.8kg (14.6 - 15.0lbs)
Power Supply Cord Kabel Wayar 电源线	5.0m (16.4ft)

Cordless
Tukul Gigitan (B&B)LED Flashlight
Lampu Senter LED
- LED 3000 B&BVacuum Cleaner
Penyedut Debu
- 18L B&BDrilling / Fastening
Gigitan / Pasang
- 18L B&BImpact Drilling / Demolition
Gigitan / Pasang
- 18L B&BCutting
Pemotong
- 18L B&BGrinding / Sanding
Moyas / Pasah
- 18L B&BSawing
Gigitan
- 18L B&BPlaning / Routing
Pogolan / Tumpang
- 18L B&BOthers
Lain-lain
- 18L B&BOutdoor Power Equipment
Alatan Penguasaan Luar
- 18L B&BMakita
TUKUL

IMPACT DRILLING | DEMOLITION

HR4003C 40mm (1-9/16")

350

Rotary Hammer

Tukul Putar
电锤



- **2-Mode operation for Rotation with Hammering or Hammering only**
Operasi 2-Mod untuk penukulan dengan putaran, penukulan sahaja
仅锤击或旋转锤击的双模式操作

Standard Equipment: Depth Gauge, Side Handle, Bit Grease, Cloth



Continuous Rating Input Input Kuasa Berterusan 额定输入功率	1,100W
Impact Energy Kekuatan Impak 单次最大锤击力	EPTA-Procedure 05/2009: 8.3J Our experimental conditions: 11.4J
Capacity Kapasiti 能力	Concrete (T.C.T. bit) : 40mm (1-9/16")/ Concrete (Core bit) : 105mm (4-1/8")
Impacts Per Minute (IPM) Impak Per Minit 冲击数	1,450 - 2,900
No Load Speed (RPM) Kelajuan Tanpa Beban 回转数	250 - 500
Dimensions (L x W x H) Dimensi 体积	479x106x263mm (18-11/16"x4-3/16"x10-3/8")
Net Weight Berat Bersih 净重	6.2 - 6.4kg (13.7 - 14.1lbs)
Power Supply Cord Kabel Wayar 电源线	5.0m (16.4ft)

HR4013C 40mm (1-9/16")

350

Rotary Hammer

Tukul Putar
电锤



- **2-Mode operation for Rotation with Hammering or Hammering only**
Operasi 2-Mod untuk penukulan dengan putaran, penukulan sahaja
仅锤击或旋转锤击的双模式操作

Standard Equipment: Depth Gauge, Side Handle (D), Side Grip, Bit Grease, Cloth



Continuous Rating Input Input Kuasa Berterusan 额定输入功率	1,100W
Impact Energy Kekuatan Impak 单次最大锤击力	EPTA-Procedure 05/2009: 8J Our experimental conditions: 11.4J
Capacity Kapasiti 能力	Concrete (T.C.T. bit) : 40mm (1-9/16")/ Concrete (Core bit) : 105mm (4-1/8")
Impacts Per Minute (IPM) Impak Per Minit 冲击数	1,450 - 2,900
No Load Speed (RPM) Kelajuan Tanpa Beban 回转数	250 - 500
Dimensions (L x W x H) Dimensi 体积	479x112x263mm (18-11/16"x4-3/8"x10-3/8")
Net Weight Berat Bersih 净重	6.8 - 6.9kg (14.9 - 15.3lbs)
Power Supply Cord Kabel Wayar 电源线	5.0m (16.4ft)

HR4030C 40mm (1-9/16")

350

Rotary Hammer

Tukul Putar
电锤

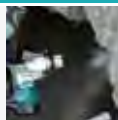

- **2-Mode operation for Rotation with Hammering or Hammering only**
Operasi 2-Mod untuk penukulan dengan putaran, penukulan sahaja
仅锤击或旋转锤击的双模式操作

Standard Equipment: Depth Gauge, Side Grip



Continuous Rating Input Input Kuasa Berterusan 额定输入功率	1,100W
Impact Energy Kekuatan Impak 单次最大锤击力	Our experimental conditions: 9.2J
Capacity Kapasiti 能力	Concrete (T.C.T. bit) : 40mm (1-9/16")/ Concrete (Core bit) : 118mm (4-5/8")
Impacts Per Minute (IPM) Impak Per Minit 冲击数	1,300 - 2,600
No Load Speed (RPM) Kelajuan Tanpa Beban 回转数	230 - 460
Dimensions (L x W x H) Dimensi 体积	413x107x247mm (16-1/4"x4-1/4"x9-3/4")
Net Weight Berat Bersih 净重	6.9kg (15.2lbs)
Power Supply Cord Kabel Wayar 电源线	5.0m (16.4ft)

HR4501C 45mm (1-3/4")

175

Rotary Hammer

Tukul Putar
电锤



- **High performance and durability**
Prestasi dan ketahanan tinggi
高性能兼耐用

Standard Equipment: Side Handle (D), Side Grip, Depth Gauge, Grease Vessel, Cloth



Continuous Rating Input Input Kuasa Berterusan 额定输入功率	1,350W
Impact Energy Kekuatan Impak 单次最大锤击力	EPTA-Procedure 05/2009: 10.1J Our experimental conditions: 12.5J
Capacity Kapasiti 能力	Concrete (T.C.T. bit) : 45mm (1-3/4")/ Concrete (Core bit) : 125mm (5")
Impacts Per Minute (IPM) Impak Per Minit 冲击数	1,250 - 2,750
No Load Speed (RPM) Kelajuan Tanpa Beban 回转数	130 - 280
Dimensions (L x W x H) Dimensi 体积	458x121x288mm (18"x4-3/4"x11-3/8")
Net Weight Berat Bersih 净重	8.2 - 8.4kg (18.1 - 18.5lbs)
Power Supply Cord Kabel Wayar 电源线	5.0m (16.4ft)

HR4511C 45mm (1-3/4")

175

Rotary Hammer

Tukul Putar
电锤

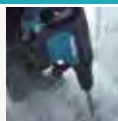

- **2-Mode operation for Rotation with Hammering or Hammering only**
Operasi 2-Mod untuk penukulan dengan putaran, penukulan sahaja
仅锤击或旋转锤击的双模式操作

Standard Equipment: Side handle (D), Side Grip, Depth Gauge, Grease Vessel, Cloth

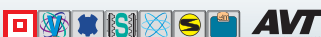

Continuous Rating Input Input Kuasa Berterusan 额定输入功率	1,350W
Impact Energy Kekuatan Impak 单次最大锤击力	EPTA-Procedure 05/2009: 9.4J Our experimental conditions: 12.5J
Capacity Kapasiti 能力	Concrete (T.C.T. bit) : 45mm (1-3/4")/ Concrete (Core bit) : 125mm (5")
Impacts Per Minute (IPM) Impak Per Minit 冲击数	1,250 - 2,750
No Load Speed (RPM) Kelajuan Tanpa Beban 回转数	130 - 280
Dimensions (L x W x H) Dimensi 体积	458x136x288mm (18"x5-3/8"x11-3/8")
Net Weight Berat Bersih 净重	9.0 - 9.1kg (19.8 - 20.1lbs)
Power Supply Cord Kabel Wayar 电源线	5.0m (16.4ft)

Cordless
Tukul Putar Tanpa Tali

LED Flashlight
Lampu Senter LED
ECO-DRIFT

Vacuum Cleaner
Penyedut Debu
M-20T

Drilling / Fastening
Dudukan / Pasang
M-10 / M-12

Impact Drilling / Demolition
Dudukan / Pasang
M-10 / M-12

Cutting / Penyatiran
Dudukan / Pasang

Grinding / Sanding
Penggosok / Pasang
Dudukan / Pasang

Banding / Routing
Dudukan / Pasang

Planing / Routing
Penggosok / Pasang

Others
Lain-lain

Outdoor Power Equipment
Alat-alat Tenaga Luar
Dudukan / Pasang

Makita
Makita

IMPACT DRILLING | DEMOLITION

HR5202C 52mm (2-1/16")

175

Rotary Hammer Tukul Putar 电锤



- **2-Mode operation for Rotation with Hammering or Hammering only**
Operasi 2-Mod untuk penukulan dengan putaran, penukulan sahaja
仅锤击或旋转锤击的双模式操作

Standard Equipment: Side handle (D), Side Grip, Depth Gauge, Grease Vessel, Cloth



Continuous Rating Input Input Kuasa Berterusan 额定输入功率	1,510W
Impact Energy Kekuatan Impak 单次最大锤击力	EPTA-Procedure 05/2009: 19.1J Our experimental conditions: 21J
Capacity Kapasiti 能力	Concrete (T.C.T. bit) : 52mm (2") Concrete (Core bit) : 160mm (6-5/16")
Impacts Per Minute (IPM) Impak Per Minit 冲击数	1,100 - 2,250
No Load Speed (RPM) Kelajuan Tanpa Beban 回转数	150 - 310
Dimensions (L x W x H) Dimensi 体积	599x134x287mm (23-1/2"x5-1/4"x11-1/4")
Net Weight Berat Bersih 净重	10.9 - 11.1kg (24.1 - 24.4lbs)
Power Supply Cord Kabel Wayar 电源线	5.0m (16.4ft)

HR5211C 52mm (2-1/16")

175

Rotary Hammer Tukul Putar 电锤



- **2-Mode operation for Rotation with Hammering or Hammering only**
Operasi 2-Mod untuk penukulan dengan putaran, penukulan sahaja
仅锤击或旋转锤击的双模式操作

Standard Equipment: Side handle (D), Side Grip, Depth Gauge, Grease Vessel



Continuous Rating Input Input Kuasa Berterusan 额定输入功率	1,500W
Impact Energy Kekuatan Impak 单次最大锤击力	EPTA-Procedure 05/2009: 18.9J Our experimental conditions: 20J
Capacity Kapasiti 能力	Concrete (T.C.T. bit) : 52mm (2") Concrete (Core bit) : 160mm (6-1/4")
Impacts Per Minute (IPM) Impak Per Minit 冲击数	1,075 - 2,150
No Load Speed (RPM) Kelajuan Tanpa Beban 回转数	130 - 260
Dimensions (L x W x H) Dimensi 体积	599x149x287mm (23-1/2"x5-7/8"x11-1/4")
Net Weight Berat Bersih 净重	12.2kg (26.8lbs)
Power Supply Cord Kabel Wayar 电源线	5.0m (16.4ft)

HR5212C 52mm (2-1/16")

175

Rotary Hammer Tukul Putar 电锤



- **2-Mode operation for Rotation with Hammering or Hammering only**
Operasi 2-Mod untuk penukulan dengan putaran, penukulan sahaja
仅锤击或旋转锤击的双模式操作

Standard Equipment: Side Handle, Side Grip, Depth Gauge, Grease Vessel, Cloth



Continuous Rating Input Input Kuasa Berterusan 额定输入功率	1,510W
Impact Energy Kekuatan Impak 单次最大锤击力	EPTA-Procedure 05/2009: 20J Our experimental conditions: 21J
Capacity Kapasiti 能力	Concrete (T.C.T. bit) : 52mm (2") Concrete (Core bit) : 160mm (6-5/16")
Impacts Per Minute (IPM) Impak Per Minit 冲击数	1,100 - 2,250
No Load Speed (RPM) Kelajuan Tanpa Beban 回转数	150 - 310
Dimensions (L x W x H) Dimensi 体积	599x140x287mm (23-1/2"x5-1/2"x11-1/4")
Net Weight Berat Bersih 净重	11.9 - 12.0kg (26.2 - 26.5lbs)
Power Supply Cord Kabel Wayar 电源线	5.0m (16.4ft)

HM0810TA 17mm (11/16") Hex Shank

105

Demolition Hammer Pemahat Tukul Elektrik 电动槌



- **Ideal for light chiseling, chipping and scaling operations**
Sesuai untuk operasi ringan untuk pahatan, penyerpihan dan perkalaan
适用于轻凿击、碎击和铲除原有表面等操作

Standard Equipment: Bull Point, Hex Wrench, Side Grip



Continuous Rating Input Input Kuasa Berterusan 额定输入功率	900W
Impact Energy Kekuatan Impak 单次最大锤击力	EPTA-Procedure 05/2009: 7.2J Our experimental conditions: 7.6J
Impacts Per Minute (IPM) Impak Per Minit 冲击数	2,900
Overall Length Panjang Keseluruhan 总长度	428mm (16-7/8")
Net Weight Berat Bersih 净重	6.3kg (13.9lbs)
Power Supply Cord Kabel Wayar 电源线	5.0m (16.4ft)

Cordless
Tukul Putar (D) (D)LED Flashlight
Lampu Suluhi LED
LED SuluhiVacuum Cleaner
Penyedut Debu
吸尘器Drilling / Fastening
Gasing / Pasang
钻孔 / 固定Impact Drilling / Demolition
Gasing / Pasang
钻孔 / 拆除Cutting
Memotong
切割Grinding / Sanding
Moyak / Pasak
打磨 / 磨光Sawing
Gasing
锯切Planing / Routing
Pegakan / Pasang
刨平 / 开槽Others
Lain-lain
其他Outdoor Power Equipment
Alat Kuasa Luar
户外动力设备Makita
Makita

IMPACT DRILLING | DEMOLITION

HM0870C

350 W

Demolition Hammer Pemahat Tukul Elektrik 电动槌



- **Compact Power with Less Weight**
Kompak dan ringan
紧凑重量

Standard Equipment: Grease for bit, Side Handle, Cloth

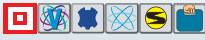

Continuous Rating Input Input Kuasa Berterusan 额定输入功率	1,100W
Impact Energy Kekuatan Impak 单次最大锤击力	EPTA-Procedure 05/2009: 7.6J Our experimental conditions: 11.4J
Impacts Per Minute (IPM) Impak Per Minit 冲击数	1,100 - 2,650
Dimensions (L x W x H) Dimensi 体积	449x109x230mm (17-3/4"x4-1/4"x9")
Net Weight Berat Bersih 净重	5.1 - 5.3kg (11.1 - 11.6lbs)
Power Supply Cord Kabel Wayar 电源线	5.0m (16.4ft)

HM0871C

350 W

Demolition Hammer Pemahat Tukul Elektrik 电动槌

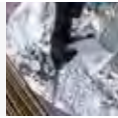

- **High durability and excellent demolition performance**
Ketahanan dan prestasi yang tinggi
高耐用性

Standard Equipment: Grease for bit, Side Handle, Cloth



Continuous Rating Input Input Kuasa Berterusan 额定输入功率	1,100W
Impact Energy Kekuatan Impak 单次最大锤击力	EPTA-Procedure 05/2009: 8.1J Our experimental conditions: 11.6J
Impacts Per Minute (IPM) Impak Per Minit 冲击数	1,100 - 2,650
Dimensions (L x W x H) Dimensi 体积	466x116x230mm (18-3/8"x4-9/16"x9")
Net Weight Berat Bersih 净重	5.6 - 5.8kg (12.4 - 12.8lbs)
Power Supply Cord Kabel Wayar 电源线	5.0m (16.4ft)

HM1201 21mm (13/16") Hex Shank

155 W

Demolition Hammer Pemahat Tukul Elektrik 电动槌

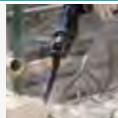

- **Powerful impact from durable aluminum body**
Tahan lama dan berkuasa
耐用铝合金机身提供强大的冲击力

Standard Equipment: Bull Point, Hex Wrench, Side Grip



Continuous Rating Input Input Kuasa Berterusan 额定输入功率	1,130W
Impact Energy Kekuatan Impak 单次最大锤击力	Our experimental conditions: 13J
Impacts Per Minute (IPM) Impak Per Minit 冲击数	2,000
Overall Length Panjang Keseluruhan 总长度	480mm (18-7/8")
Net Weight Berat Bersih 净重	9.1kg (20.1lbs)
Power Supply Cord Kabel Wayar 电源线	5.0m (16.4ft)

HM1213C

175 W

Demolition Hammer Pemahat Tukul Elektrik 电动槌



- **Vibration absorbing handle provides comfortable operation**
Pemegang menyerap getaran untuk operasi yang selesa
吸振手柄提供舒适的操作

Standard Equipment: Bull Point, Bit Grease, Side Handle, Cloth



Continuous Rating Input Input Kuasa Berterusan 额定输入功率	1,510W
Impact Energy Kekuatan Impak 单次最大锤击力	EPTA-Procedure 05/2009: 18.6J Our experimental conditions: 25.5J
Impacts Per Minute (IPM) Impak Per Minit 冲击数	950 - 1,900
Dimensions (L x W x H) Dimensi 体积	576x149x265mm (22-3/4"x5-7/8"x10-3/8")
Net Weight Berat Bersih 净重	10.8kg (23.7lbs)
Power Supply Cord Kabel Wayar 电源线	5.0m (16.4ft)

HM1203C

175 W

Demolition Hammer Pemahat Tukul Elektrik 电动槌



- **Increasing energy transfer for more power**
Meningkatkan pemindahan tenaga untuk lebih banyak kuasa
增加能量传递以获得更多电力

Standard Equipment: Bull Point, Bit Grease, Side Handle



Continuous Rating Input Input Kuasa Berterusan 额定输入功率	1,510W
Impact Energy Kekuatan Impak 单次最大锤击力	EPTA-Procedure 05/2009: 19.1J Our experimental conditions: 25.5J
Impacts Per Minute (IPM) Impak Per Minit 冲击数	950 - 1,900
Dimensions (L x W x H) Dimensi 体积	576x128x265mm (22-3/4"x5"x10-3/8")
Net Weight Berat Bersih 净重	9.7kg (21.5lbs)
Power Supply Cord Kabel Wayar 电源线	5.0m (16.4ft)

IMPACT DRILLING | DEMOLITION

HM1214C

Demolition Hammer Pemahat Tukul Elektrik 电动锤



- **Powerful 1,510W motor**
Motor berkuasa 1,510W
强大马达1,510W

Standard Equipment: Bull Point, Bit Grease, Side Handle, Cloth



175

Continuous Rating Input Input Kuasa Berterusan 额定输入功率	1,510W
Impact Energy Kekuatan Impak 单次最大锤击力	EPTA-Procedure 05/2009: 19.9J Our experimental conditions: 26J
Impacts Per Minute (IPM) Impak Per Minit 冲击数	950 - 1,900
Dimensions (L x W x H) Dimensi 体积	700x129x265mm (27-1/2"x5-1/8"x10-3/8")
Net Weight Berat Bersih 净重	12.3kg (27.1lbs)
Power Supply Cord Kabel Wayar 电源线	5.0m (16.4ft)

HM1306 30mm (1-3/16") Hex Shank

Demolition Hammer Pemahat Tukul Elektrik 电动锤



- **Powerful 1,510W motor**
Motor berkuasa 1,510W
强大马达1,510W

Standard Equipment: Bull Point, Wrench, Side Handle,
Oil Supply 100ml



204

Continuous Rating Input Input Kuasa Berterusan 额定输入功率	1,510W
Impact Energy Kekuatan Impak 单次最大锤击力	EPTA-Procedure 05/2009: 21.7J Our experimental conditions: 28.8J
Impacts Per Minute (IPM) Impak Per Minit 冲击数	1,450
Dimensions (L x W x H) Dimensi 体积	652x121x231mm (25-3/4"x4-3/4"x9-1/8")
Net Weight Berat Bersih 净重	15.1kg (33.3lbs)
Power Supply Cord Kabel Wayar 电源线	5.0m (16.4ft)

HM1317C 30mm (1-3/16") Hex Shank

Electric Breaker Tukul Elektrik 电动锤



- **High durability and excellent demolition performance**
Ketahanan dan berprestasi tinggi
高耐用性

Standard Equipment: Side Handle



175

Continuous Rating Input Input Kuasa Berterusan 额定输入功率	1,510W
Impact Energy Kekuatan Impak 单次最大锤击力	EPTA-Procedure 05/2009: 25 (100-127 V: 21) J Our experimental conditions: 33.8 J
Impacts Per Minute (IPM) Impak Per Minit 冲击数	730 - 1,450
Dimensions (L x W x H) Dimensi 体积	715x129x266mm (28-1/8"x5-1/8"x10-1/2")
Net Weight Berat Bersih 净重	17kg (37.5lbs)
Power Supply Cord Kabel Wayar 电源线	5.0m (16.4ft)

HM1307C 30mm (1-3/16") Hex Shank

Electric Breaker Tukul Elektrik 电动锤



- **Electronic Controller for Operator Convenience**
Kawalan Elektronik memudahkan pengguna
电子控制方便使用

Standard Equipment: Side Handle, Bull Point



175

Continuous Rating Input Input Kuasa Berterusan 额定输入功率	1,510W
Impact Energy Kekuatan Impak 单次最大锤击力	EPTA-Procedure 05/2009: 25.5J Our experimental conditions: 33.8J
Impacts Per Minute (IPM) Impak Per Minit 冲击数	730 - 1,450
Dimensions (L x W x H) Dimensi 体积	715x129x266mm (28-1/8"x5-1/8"x10-1/2")
Net Weight Berat Bersih 净重	15.3kg (33.8lbs)
Power Supply Cord Kabel Wayar 电源线	5.0m (16.4ft)

HM1501 30mm (1-3/16") Hex Shank

Electric Breaker Tukul Kombinasi 电冲击钻锤

- **Both drastically increased power and low vibration are achieved with minimum increase in tool size and weight**
Mencapai peningkatan daya yang kuat dan getaran rendah dengan ukuran alat dan berat yang terkecil
以最小的工具尺寸和重量增加实现了功率的急剧增加和低振动

Standard Equipment: Side Handle, Bull Point



218

Continuous Rating Input Input Kuasa Berterusan 额定输入功率	1,850W
Impact Energy Kekuatan Impak 单次最大锤击力	EPTA-Procedure 05/2009: 48.1J
Impacts Per Minute (IPM) Impak Per Minit 冲击数	1,300
Dimensions (L x W x H) Dimensi 体积	781x130x266mm (30-3/4"x5-1/8"x10-1/2")
Net Weight Berat Bersih 净重	18.4kg (40.6lbs.)
Power Supply Cord Kabel Wayar 电源线	5.0m (16.4ft)

Cordless
Tutupi Alat (B.A.)LED Flashlight
Lampu Senter LED
- LED 3000 B.C.T.Vacuum Cleaner
Penyedut Debu
- 20.0LDrilling / Fastening
Gasing / Pasak
- 10.0L / 10.0LImpact Drilling / Demolition
Gasing / Pemahat
- 10.0L / 10.0LCutting
Pemotong
- 10.0LGrinding / Sanding
Moyas / Pasak
- 10.0L / 10.0LSawing
Gasing
- 10.0LPlaning / Routing
Pogasan / Pasak
- 10.0L / 10.0LOthers
Lain-lain
- 10.0LOutdoor Power Equipment
Alat Luar Ruangan
- 10.0L / 10.0LMakita
Tutupi Alat

IMPACT DRILLING | DEMOLITION

HM1511 30mm (1-3/16") Hex Shank

218 WATT

Electric Breaker

Tukul Kombinasi
电冲击钻锤

- Both drastically increased power and low vibration are achieved with minimum increase in tool size and weight

Mencapai peningkatan daya yang kuat dan getaran rendah dengan ukuran alat dan berat yang terkecil
以最小的工具尺寸和重量增加实现了功率的急剧增加和低振动



Standard Equipment: Side Handle, Bull Point



HM1810 28.6mm (1-1/8") Hex Shank

204 WATT

Electric Breaker

Tukul Elektrik
电动锤

- Powerful 2,000W motor
Motor berkuasa 2,000W
强大马达2,000W



Standard Equipment: Hex Wrench



HM1812 28.6mm (1-1/8") Hex Shank

218 WATT

Electric Breaker

Tukul Elektrik
电动锤

- Hits like air without the vibration
Tukulan mudah
轻易敲击



Standard Equipment: Bull Point, Hex Wrench



HK1820

350 WATT

Power Scraper

Pengikis Elektrik
电动刮剥机

- Large trigger switch with variable speed control function
Suis pencetus yang besar dengan fungsi kawalan kelajuan
备用变速控制功能的大型触发开关



Standard Equipment: Bull Point, Scaling Chisel, Scaling chisel (for tile), Hook complete



Continuous Rating Input Input Kuasa Berterusan 额定输入功率	1,850W
Impact Energy Kekuatan Impak 单次最大冲击力	EPTA-Procedure 05/2009: 48.9J
Impacts Per Minute (IPM) Impak Per Minit 冲击数	1,300
Dimensions (L x W x H) Dimensi 体积	781x130x266mm (30-3/4x5-1/8x10-1/2")
Net Weight Berat Bersih 净重	19.2kg (42.3lbs.)
Power Supply Cord Kabel Wayar 电源线	5.0m (16.4ft)

Continuous Rating Input Input Kuasa Berterusan 额定输入功率	2,000W
Impact Energy Kekuatan Impak 单次最大冲击力	EPTA-Procedure 05/2009: 44.9J Our experimental conditions: 63J
Impacts Per Minute (IPM) Impak Per Minit 冲击数	1,100
Dimensions (L x W x H) Dimensi 体积	824x146x633mm (32-1/2"x5-3/4"x25")
Net Weight Berat Bersih 净重	32.0kg (70.6lbs)
Power Supply Cord Kabel Wayar 电源线	5.0m (16.4ft)

Continuous Rating Input Input Kuasa Berterusan 额定输入功率	2,000W
Impact Energy Kekuatan Impak 单次最大冲击力	EPTA-Procedure 05/2009: 72.8J Our experimental conditions: 62J
Impacts Per Minute (IPM) Impak Per Minit 冲击数	870
Dimensions (L x W x H) Dimensi 体积	843x210x608mm (33-1/4"x8-1/4"x24")
Net Weight Berat Bersih 净重	31.3kg (69lbs)
Power Supply Cord Kabel Wayar 电源线	5.0m (16.4ft)

Continuous Rating Input Input Kuasa Berterusan 额定输入功率	550W
Impact Energy Kekuatan Impak 单次最大冲击力	EPTA-Procedure 05/2009: 3.1J Our experimental conditions: 3.9J
Impacts Per Minute (IPM) Impak Per Minit 冲击数	0 - 3,200
Dimensions (L x W x H) Dimensi 体积	351x102x203mm (13-3/4"x4"x8")
Net Weight Berat Bersih 净重	3.4kg (7.5lbs)
Power Supply Cord Kabel Wayar 电源线	5.0m (16.4ft)

Cordless
Tukul Point 电钻LED Flashlight
Lampu Sinar LED
LED-BOHITVacuum Cleaner
Penyedut Vakuum
吸尘器Drilling / Fastening
Druil / Pasang
钻孔 / 固定Impact Drilling / Demolition
Druil / Rombok
冲击钻孔 / 拆除工程Cutting / Penetration
Druil
切割Grinding / Sanding
Mergat / Gores
打磨 / 磨光Banding / Smoothing
Druil
打磨 / 平滑Planing / Routing
Pergolan / Tengking
刨平 / 开槽Others
Lain-lain
其他Outdoor Power Equipment
Alat Berdaya Luar
户外动力设备Makita
MAKITA

Combination / Rotary Hammer Drill Capability Chart

Jadual keupayaan gerudi 钻孔能力表

 Tungsten Carbide-tipped usable range
 Recommended range
 Core bits
 ✓✓✓ Optimal
 ✓ Possible

		Impact energy according to EPTA05/2009: J	EPTA Weight (kg)	EPTA Weight (kg)																	MATERIAL FOR DRILLING			
Series	Model			0	10	20	30	40	50	60	70	80	90	100	110	120	130	140	150	160	Highly reinforced concrete	Concrete, granite, stone, brick	Metal/wood	Working direction
14mm series	HR140D	1.0J	1.9 - 2.6	3.2-14 3.2-10																	✓	✓✓✓	✓	↕
	SDS-plus			3.2-14 3.2-10																	✓	✓✓✓	✓	

		Impact energy according to EPTA05/2009: J	EPTA Weight (kg)	EPTA Weight (kg)																	MATERIAL FOR DRILLING			
Series	Model			0	10	20	30	40	50	60	70	80	90	100	110	120	130	140	150	160	Highly reinforced concrete	Concrete, granite, stone, brick	Metal/wood	Working direction
16mm series	DHR165	1.3J	2.3 - 3.0	3.2-16 3.2-10																	✓	✓✓✓	✓	↕
	SDS-plus			3.2-16 3.2-10 35 Diamond core 32 (dry type)																	✓	✓✓✓	✓	
16mm series	HR166D	1.1J	1.8 - 2.4	3.2-16 3.2-10																	✓	✓✓✓	✓	↕

		Impact energy according to EPTA05/2009: J	EPTA Weight (kg)	EPTA Weight (kg)																	MATERIAL FOR DRILLING			
Series	Model			0	10	20	30	40	50	60	70	80	90	100	110	120	130	140	150	160	Highly reinforced concrete	Concrete, granite, stone, brick	Metal/wood	Working direction
17mm series	DHR171	1.2J	2.1 - 2.8	3.2-17 3.2-10																	✓	✓✓✓	✓	↕
	SDS-plus			3.2-17 3.2-10																	✓	✓✓✓	✓	

		Impact energy according to EPTA05/2009: J	EPTA Weight (kg)	EPTA Weight (kg)																	MATERIAL FOR DRILLING			
Series	Model			0	10	20	30	40	50	60	70	80	90	100	110	120	130	140	150	160	Highly reinforced concrete	Concrete, granite, stone, brick	Metal/wood	Working direction
18mm series	DHR182	1.7J	2.4 - 3.2	3.2-18 3.2-10																	✓	✓✓✓	✓	↕
	SDS-plus			3.2-18 3.2-10 35 Diamond core 32 (dry type)																	✓	✓✓✓	✓	
18mm series	HR1841F	1.4J	2.0 - 2.5	3.2-18 3.2-10																	✓	✓✓✓	✓	↕
	SDS-plus			3.2-18 3.2-10 35 Diamond core 32 ~ 65 (dry type)																	✓	✓✓✓	✓	
18mm series	HR1840	1.4J	2.0 - 2.5	3.2-18 3.2-10																	✓	✓✓✓	✓	↕
	SDS-plus			3.2-18 3.2-10 35 Diamond core 32 ~ 65 (dry type)																	✓	✓✓✓	✓	
18mm series	HR1830	1.2J	1.9	3.2-18 3.2-10																	✓	✓✓✓	✓	↕
	SDS-plus			3.2-18 3.2-10 35 Diamond core 32 ~ 65 (dry type)																	✓	✓✓✓	✓	

		Impact energy according to EPTA05/2009: J	EPTA Weight (kg)	EPTA Weight (kg)																	MATERIAL FOR DRILLING			
Series	Model			0	10	20	30	40	50	60	70	80	90	100	110	120	130	140	150	160	Highly reinforced concrete	Concrete, granite, stone, brick	Metal/wood	Working direction
20mm series	DHR202	1.9J	3.2 - 4.0	3.2-20 4-12																	✓	✓✓✓	✓	↕
	SDS-plus			3.2-20 4-12 35-54 Diamond core 32 (dry type)																	✓	✓✓✓	✓	
20mm series	DHR241	1.9J	3.2 - 4.0	3.2-20 4-12																	✓	✓✓✓	✓	↕
	SDS-plus			3.2-20 4-12 35-54 Diamond core 32 (dry type)																	✓	✓✓✓	✓	
20mm series	HR2020	2.2J	2.6	3.2-20 4-12																	✓	✓✓✓	✓	↕
	SDS-plus			3.2-20 4-12 35-54 Diamond core 32 ~ 65 (dry type)																	✓	✓✓✓	✓	

		Impact energy according to EPTA05/2009: J	EPTA Weight (kg)	EPTA Weight (kg)																	MATERIAL FOR DRILLING			
Series	Model			0	10	20	30	40	50	60	70	80	90	100	110	120	130	140	150	160	Highly reinforced concrete	Concrete, granite, stone, brick	Metal/wood	Working direction
23mm series	HR2320T	2.3J	2.9 - 3.2	3.2-23 4-15																	✓	✓✓✓	✓	↕
	SDS-plus			3.2-23 4-15 35-68 Diamond core 32 ~ 70 (dry type)																	✓	✓✓✓	✓	

		Impact energy according to EPTA05/2009: J	EPTA Weight (kg)	EPTA Weight (kg)																	MATERIAL FOR DRILLING			
Series	Model			0	10	20	30	40	50	60	70	80	90	100	110	120	130	140	150	160	Highly reinforced concrete	Concrete, granite, stone, brick	Metal/wood	Working direction
24mm series	DHR242	2.0J	3.1 - 3.8	3.2-24 4-16																	✓	✓✓✓	✓	↕
	SDS-plus			3.2-24 4-16 35-54 Diamond core 32 ~ 65 (dry type)																	✓	✓✓✓	✓	
24mm series	HR2470	2.4J	2.9 - 3.3	3.2-24 4-16																	✓	✓✓✓	✓	↕
	SDS-plus			3.2-24 4-16 35-54 Diamond core 32 ~ 65 (dry type)																	✓	✓✓✓	✓	

		Impact energy according to EPTA05/2009: J	EPTA Weight (kg)	EPTA Weight (kg)																	MATERIAL FOR DRILLING			
Series	Model			0	10	20	30	40	50	60	70	80	90	100	110	120	130	140	150	160	Highly reinforced concrete	Concrete, granite, stone, brick	Metal/wood	Working direction
26mm series	DHR263	2.5J	4.1 - 5.1	3.2-26 4-18																	✓	✓✓✓	✓	↕
	SDS-plus			3.2-26 4-18 35-54 Diamond core 32 ~ 65 (dry type)																	✓	✓✓✓	✓	
26mm series	HR2652	2.2J	3.0 - 4.3	3.2-26 4-18																	✓	✓✓✓	✓	↕
	SDS-plus			3.2-26 4-18 35-68 Diamond core 32 ~ 80 (dry type)																	✓	✓✓✓	✓	
26mm series	HR2631FT	2.4J	2.8 - 3.5	3.2-26 4-18																	✓	✓✓✓	✓	↕
	SDS-plus			3.2-26 4-18 35-68 Diamond core 32 ~ 80 (dry type)																	✓	✓✓✓	✓	
26mm series	HR2630	2.4J	2.8 - 3.5	3.2-26 4-18																	✓	✓✓✓	✓	↕
	SDS-plus			3.2-26 4-18 35-68 Diamond core 32 ~ 80 (dry type)																	✓	✓✓✓	✓	
26mm series	HR2611FT	2.4J	2.8 - 3.0	3.2-26 4-18																	✓	✓✓✓	✓	↕
	SDS-plus			3.2-26 4-18 35-68 Diamond core 32 ~ 80 (dry type)																	✓	✓✓✓	✓	

		Impact energy according to EPTA05/2009: J	EPTA Weight (kg)	Impact energy scale (0-160 J)																MATERIAL FOR DRILLING			
Series	Model			0	10	20	30	40	50	60	70	80	90	100	110	120	130	140	150	160	Highly reinforced concrete	Concrete, granite, stone, brick	Metal/wood
28mm series	DHR280	2.8J	3.9 - 5.0	3.2-28 6-20 35-54 Diamond core 32 ~ 65 (dry type)																✓	✓✓✓	✓	↕
	SDS-plus																						
28mm series	DHR282	2.8J	3.9 - 4.9	3.2-28 6-20 35-54 Diamond core 32 ~ 65 (dry type)																✓	✓✓✓	✓	↕
	SDS-plus																						
28mm series	HR001G HR003G	2.8J	3.9 - 4.6	3.2-28 6-20 35-54 Diamond core 32 ~ 65 (dry type)																✓	✓✓✓	✓	↕
	SDS-plus																						
28mm series	HR002G	2.9J	4.1 - 4.6	3.2-28 6-20 35-54 Diamond core 32 ~ 65 (dry type)																✓	✓✓✓	✓	↕
	SDS-plus																						
28mm series	HR2810	3.9J	3.4 - 3.9	3.2-28 6-20 35-80 Diamond core 32 ~ 80 (dry type)																✓	✓✓✓	✓	↕
	SDS-plus																						

		Impact energy according to EPTA05/2009: J	EPTA Weight (kg)	Impact energy scale (0-160 J)																MATERIAL FOR DRILLING			
Series	Model			0	10	20	30	40	50	60	70	80	90	100	110	120	130	140	150	160	Highly reinforced concrete	Concrete, granite, stone, brick	Metal/wood
30mm series	HR3001C	3.9J	4.4 - 4.8	4-30 10-22 35-80 Diamond core 32 ~ 80 (dry type)																✓✓✓	✓✓✓	✓	↕
	SDS-plus																						
30mm series	HR3011FC	3.9J	4.1 - 4.5	4-30 10-22 35-80 Diamond core 32 ~ 80 (dry type)																✓✓✓	✓✓✓	✓	↕
	SDS-plus																						

		Impact energy according to EPTA05/2009: J	EPTA Weight (kg)	Impact energy scale (0-160 J)																MATERIAL FOR DRILLING			
Series	Model			0	10	20	30	40	50	60	70	80	90	100	110	120	130	140	150	160	Highly reinforced concrete	Concrete, granite, stone, brick	Metal/wood
32mm series	HR3210C	5.0J	4.8 - 5.6	4-32 10-22 35-90 Diamond core 32 ~ 90 (dry type)																✓✓✓	✓✓✓	✓	↕
	SDS-plus																						
32mm series	HR3200C	5.1J	4.8 - 5.6	4-32 10-22 35-90 Diamond core 32 ~ 90 (dry type)																✓✓✓	✓✓✓	✓	↕
	SDS-plus																						

		Impact energy according to EPTA05/2009: J	EPTA Weight (kg)	Impact energy scale (0-160 J)																MATERIAL FOR DRILLING			
Series	Model			0	10	20	30	40	50	60	70	80	90	100	110	120	130	140	150	160	Highly reinforced concrete	Concrete, granite, stone, brick	Metal/wood
35mm series	HR3530	6.2J	5.8	10-35 12-25 25-105																✓✓✓	✓✓✓		↕
	17mm Hex																						

		Impact energy according to EPTA05/2009: J	EPTA Weight (kg)	Impact energy scale (0-160 J)																MATERIAL FOR DRILLING			
Series	Model			0	10	20	30	40	50	60	70	80	90	100	110	120	130	140	150	160	Highly reinforced concrete	Concrete, granite, stone, brick	Metal/wood
40mm series	DHR400	8.0J	4.1 - 4.6	10-40 16-35 20-105																✓✓✓	✓✓✓		↕
	SDS-max																						
40mm series	HR005G	8.0J	4.1 - 4.6	10-40 16-35 20-105																✓✓✓	✓✓✓		↕
	SDS-max																						
40mm series	HR4013C	8.0J	6.2 - 6.9	10-40 16-35 20-105																✓✓✓	✓✓✓		↕
	SDS-max																						
40mm series	HR4003C	8.3J	6.2 - 6.9	10-40 16-35 20-105																✓✓✓	✓✓✓		↕
	SDS-max																						
40mm series	HR4001C	6.8J	6.3 - 6.7	10-40 16-35 20-105																✓✓✓	✓✓✓		↕
	SDS-max																						
40mm series	HR4002	6.1J	6.6 - 6.8	10-40 16-32 20-105																✓✓✓	✓✓✓		↕
	SDS-max																						
40mm series	HR4030C	9.2J	6.9	10-40 22-35 25-118																✓✓✓	✓✓✓		↕
	17mm Hex																						

		Impact energy according to EPTA05/2009: J	EPTA Weight (kg)	Impact energy scale (0-160 J)																MATERIAL FOR DRILLING			
Series	Model			0	10	20	30	40	50	60	70	80	90	100	110	120	130	140	150	160	Highly reinforced concrete	Concrete, granite, stone, brick	Metal/wood
45mm series	HR4511C	9.4J	8.9 - 9.1	10-45 22-40 20-125																✓✓✓	✓✓✓		↕
	SDS-max																						
45mm series	HR4501C	10.1J	8.9 - 9.1	10-45 22-40 20-125																✓✓✓	✓✓✓		↕
	SDS-max																						

		Impact energy according to EPTA05/2009: J	EPTA Weight (kg)	Impact energy scale (0-160 J)																MATERIAL FOR DRILLING			
Series	Model			0	10	20	30	40	50	60	70	80	90	100	110	120	130	140	150	160	Highly reinforced concrete	Concrete, granite, stone, brick	Metal/wood
52mm series	HR006G	21.4J	12.9 - 14.3	19-52 25-45 20-160																✓✓✓	✓✓✓		↕
	SDS-max																						
52mm series	HR5212C	20.0J	11 - 12	19-52 25-45 20-160																✓✓✓	✓✓✓		↕
	SDS-max																						
52mm series	HR5202C	19.1J	11 - 12	19-52 25-45 20-160																✓✓✓	✓✓✓		↕
	SDS-max																						
52mm series	HR5211C	18.9J	11.3 - 12.2	19-52 25-45 20-160																✓✓✓	✓✓✓		↕
	SDS-max																						

CUTTING

Pemotong 切割



CUTTING (New Material | Masonry | Metal)

4112HS 305mm (12")

204

Angle Cutter Mesin Pemotong 切割机



- **Smooth and comfortable cutting**
Pemotongan lancar dan selesa
平滑切割

Standard Equipment: Socket Wrench



Continuous Rating Input Input Kuasa Berterusan 额定输入功率	2,400W
Capacity Kapasiti 能力	Max cutting : 100mm (4")
Blade Diameter Diameter Bilah 锯片直径	305mm (12")
No Load Speed (RPM) Kelajuan Tanpa Beban 回转数	5,000
Overall Length Panjang Keseluruhan 总长度	648mm (25-1/2")
Net Weight Berat Bersih 净重	10.4kg (22.9lbs)
Power Supply Cord Kabel Wayar 电源线	2.5m (8.2ft)

4114S 355mm (14")

204

Angle Cutter Mesin Pemotong 切割机



- **Faster cutting for increased productivity**
Pemotongan cepat meningkatkan produktiviti
更快的切割提高生产力

Standard Equipment: Wrench



Continuous Rating Input Input Kuasa Berterusan 额定输入功率	2,400W
Capacity Kapasiti 能力	Max cutting : 125mm (5")
Wheel Diameter Diameter Bilah 锯片直径	355mm (14")
Hole Diameter Diameter Lubang 孔直径	25.4mm (1")
No Load Speed (RPM) Kelajuan Tanpa Beban 回转数	3,500
Dimensions (L x W x H) Dimensi 体积	673x240x329mm (26-1/2"x9-1/2"x13")
Net Weight Berat Bersih 净重	10.8kg (23.9lbs)
Power Supply Cord Kabel Wayar 电源线	2.5m (8.2ft)

SG1251J 125mm (5")

318

Wall Chaser Mesin Pemotong Dinding 石材开槽切割机



- **Clean, compact and comfortable**
Bersih, padat dan selesa
干净, 紧凑, 舒适

Standard Equipment: Diamond Wheel x2, Hex Wrench,
Lock Nut Wrench



Continuous Rating Input Input Kuasa Berterusan 额定输入功率	1,400W
Capacity Kapasiti 能力	Depth : 0-30mm (0 - 1-3/16") Width: 6-30mm (1/4 - 1-3/16")
Blade Diameter Diameter Bilah 锯片直径	125mm (5")
No Load Speed (RPM) Kelajuan Tanpa Beban 回转数	10,000
Dimensions (L x W x H) Dimensi 体积	350x151x178mm (13-3/4"x5-15/16"x7")
Net Weight Berat Bersih 净重	4.3kg (9.5lbs)
Power Supply Cord Kabel Wayar 电源线	5.0m (16.4ft)

4131 185mm (7-1/4")

303

Metal Cutter Mesin Memotong Logam 金属切割机



- **Powerful 1,100W motor cuts through various types of metal**
Motor berkuasa 1,100W sesuai untuk memotong pelbagai jenis logam
强力1,100W马达可切割多种金属

Standard Equipment: Carbide-Tipped Saw Blade (B-04628),
Hex Wrench, Safety Goggles



Continuous Rating Input Input Kuasa Berterusan 额定输入功率	1,100W
Blade Diameter Diameter Bilah 锯片直径	185mm (7-1/4")
Capacity Kapasiti 能力	Max cutting : 63mm (2-1/2")
No Load Speed (RPM) Kelajuan Tanpa Beban 回转数	3,500
Overall Length Panjang Keseluruhan 总长度	358mm (14-1/8")
Net Weight Berat Bersih 净重	4.8kg (11.3lbs)
Power Supply Cord Kabel Wayar 电源线	2.5m (8.2ft)

Cordless
Tanda Aki (B/C)

LED Flashlight
Tanda Cahaya LED
LED LIGHT

Vacuum Cleaner
Penyedut Debu
VACUUM

Drilling / Fastening
Dua / Pasang
DRILL / FASTEN

Impact Drilling / Demolition
Dua / Hancurkan
IMPACT DRILL / DEMO

Cutting
Potong
CUT

Grinding / Sanding
Tungku / Pasir
GRIND / SAND

Sanding
Dua
SAND

Planing / Routing
Perataan / Tugu
PLAN / ROUTE

Others
Lain-lain
OTHER

Outdoor Power Equipment
Alatan Penguasaan Luar
OUTDOOR P.E.

Makita
TIME

CUTTING (New Material | Masonry | Metal)

LC1230 305mm (12")

203

Metal Cutting Saw
Mesin Memotong Logam
金属型材切割机



• For Cutting in Pipe, Angle Iron, Conduit and More
Untuk pemotongan paip, sesiku besi, konduit dan banyak lagi
用于切割管道, 角铁, 导管等

Standard Equipment: Carbide-Tipped Saw Blade, Socket Wrench, Safety Goggles



Continuous Rating Input Input Kuasa Berterusan 额定输入功率	1,750W
Blade Diameter Diameter Bilah 锯片直径	305mm (12")
Max Cutting Capacity Kapasiti Pemotongan Maksimum 最大切割能力	90°: 115mm (4-1/2") 90°: 75 x 150mm (2-15/16" x 5-7/8") 45°: 90mm (3-1/2") 45°: 85 x 85mm (3-5/16" x 3-5/16")
No Load Speed (RPM) Kelajuan Tanpa Beban 回转数	1,300
Dimensions (L x W x H) Dimensi 体积	516x306x603mm (20-1/4"x12"x23-3/4")
Net Weight Berat Bersih 淨重	19.3kg (42.5lbs)
Power Supply Cord Kabel Wayar 电源线	2.5m (8.2ft)

Why Makita Carbide-tipped Metal Cutting saw VS. Abrasive Cutting Saw



Carbide-Tipped Blades make Virtually Spark-Free Cuts



Abrasive Blades make Cuts with Sparks

Makita's Carbide-Tipped Metal Blades Cuts Cleaner

Tubing	Threaded Rod	UNISTRUT™	Angle Iron	Pipe
Makita Carbide-Tipped Blade	Makita Carbide-Tipped Blade	Makita Carbide-Tipped Blade	Makita Carbide-Tipped Blade	Makita Carbide-Tipped Blade
Abrasive Blade	Abrasive Blade	Abrasive Blade	Abrasive Blade	Abrasive Blade

Carbide-Tipped Metal Blades for Many Applications

Applications				Angle		Tubing		Channel		Round Pipe
Size (mm)	Tip thickness	Part No.	Nominal thickness	6mm	4mm	3mm	4.5mm	2.3mm	3.2mm	3.8mm
305 x 60T (Mild steel)	2.1mm	A-87242		○	○	○	△	×	◎	◎
305 x 60T (Mild steel)	2.5mm	A-81860		○	○	◎	○	×	◎	◎
305 x 60T (Mild steel) <small>lessend noise</small>	2.4mm	A-86723		◎	◎	◎	○	×	◎	◎
305 x 78T (Thin steel)	2.3mm	A-87127		△	△	△	×	○	△	△
305 x 76T (Thin steel)	1.95mm	A-87579		○	○	△	×	◎	△	◎

Cordless
LED Flashlight
Vacuum Cleaner
Drilling / Fastening
Impact Drilling / Demolition
Cutting / Perforating
Grinding / Sanding
Sawing
Planing / Routing
Others
Outdoor Power Equipment



CUTTING (New Material | Masonry | Metal)

Metal Cutting Process

Carbide-Tipped Metal Blade Cutting Tips

- Always wear safety glasses, gloves, protective equipment and follow instructions provided with power tool
- Do not apply excessive pressure on the handle when cutting as damage to the carbide-tips can be a result
- Too little or too much pressure on the handle may result in more sparks and premature blade wear
- Use block spacers when cutting square/rectangle tubing as well as channel and UNISTRUT™ for longer blade life
- When cutting long pieces of metal always use support blocks on both sides so the metal will be level with the saw base
- Do not touch blade or metal immediately after cut

Metal Cutting Process



Square & Rectangle Tubing (use block spacer)

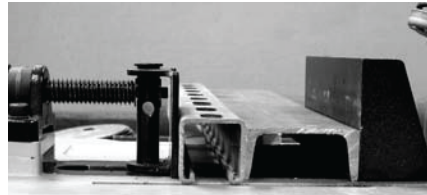

Channels & UNISTRUT™ (use block spacer)



Angle



Round Pipe



Threaded Rod

Carbide-Tipped Metal Blade Cutting Tips

- 1 Ensure metal is properly placed on saw base and firmly secured in the saw
- 2 Hold the saw handle firmly and wait until full speed is obtained
- 3 Lower the handle gently to bring the blade close to the metal
- 4 Gently ease the blade into the metal and add minimal pressure (reduce pressure if sparks appear)
- 5 After completed cut, turn off power tool and wait until blade has come to a complete stop then raise the handle back (if handle is raised back with blade still rotating then the blade may be caught)

Block Spacer Reference Chart

Applications	Square & Rectangle Tubing				Round Pipe		Square & Rectangle Tubing		Round Pipe		
	Up to 75 mm		Up to 100 mm		—		Up to 85 mm		—		
<p>Block Spacer</p> <p>Material</p> <p>A B</p> <p>(mm)</p>	A	B	A	B	A	B	A	B	A	B	
	90 Degree Cutting	25	125	25	75	25	90	25	60	25	65
		50	100	50	50	50	65	50	35	50	40
		75	75	75	25	75	40	75	10	75	15
		100	50	100	0	100	15	85	0	90	0
		125	25	—	—	115	0	—	—	—	—
		*150	0	—	—	—	—	—	—	—	—
45 Degree Cutting											

*Hint: Block Spacer should be determined by subtracting the metal width from 150 mm.

Cordless
Tango Acid (Lithium)

LED Flashlight
Temp Sensor, LED
COMBIBIT

Vacuum Cleaner
Turbo Motor
BLDC

Drilling | Fastening
Cable | Plugless
MIL | 3.0

Impact Drilling | Demolition
Dual | Airbrush
ECLAM | 4.0/5.0

Cutting | Routing
Pushing
3.0

Grinding | Sanding
Through | Brush
3.0 | 3.0

Sanding
Cable
3.0

Planing | Routing
Perforated | Tealuminum
3.0 | 3.0

Others
3.0

Outdoor Power Equipment
Aluminum Fuel Unit
3.0/3.0

Makita
TIME

CUTTING (New Material | Masonry)

4100NH 110mm (4-3/8")

303 

Cutter

Mesin Pemotong
切割机



- **Powerful cutting in stone, masonry, tile & concrete**
Berkuasa untuk memotong batu, masonri, jubin & konkrit
有力的切割石材, 砖石, 瓷砖和混凝土

Standard Equipment: **Wrench, Socket Wrench**



Continuous Rating Input Input Kuasa Berterusan 额定输入功率	1,300W
Blade Diameter Diameter Bilah 锯片直径	110mm (4-3/8")
Max Cutting Capacity Kapasiti Pemotongan Maksimum 最大切割能力	90°: 34mm (1-3/8")
No Load Speed (RPM) Kelajuan Tanpa Beban 回转数	14,500
Dimensions (L x W x H) Dimensi 体积	234x210x165mm (9-1/4"x8-1/4"x6-1/2")
Net Weight Berat Bersih 净重	2.9kg (6.5lbs)
Power Supply Cord Kabel Wayar 电源线	2.5m (8.2ft)

4100NH2Z 110mm (4-3/8")

303 

Cutter

Mesin Pemotong
切割机



- **Bevel-cuts up to 45 degrees**
Potongan serong hingga 45°
45° 斜角切割

Standard Equipment: **Wrench, Hex Wrench**



Continuous Rating Input Input Kuasa Berterusan 额定输入功率	1,400W
Blade Diameter Diameter Bilah 锯片直径	Max 125mm (Max 5")
Max Cutting Capacity w/ 110mm (4-3/8") wheel Kapasiti Pemotongan Maksimum 最大切割能力	90°: 32.5mm (1-1/4") 45°: 21.5mm (7/8")
Max Cutting Capacity w/ 125mm (5") wheel Kapasiti Pemotongan Maksimum 最大切割能力	90°: 40.0mm (1-9/16") 45°: 27.0mm (1-1/16")
No Load Speed (RPM) Kelajuan Tanpa Beban 回转数	12,200
Dimensions (L x W x H) Dimensi 体积	238x214x169mm (9-3/8"x8-3/8"x6-5/8")
Net Weight Berat Bersih 净重	3kg (6.6lbs)
Power Supply Cord Kabel Wayar 电源线	2.5m (8.2ft.)

4100NH3Z 110mm (4-3/8")

303 

Cutter

Mesin Pemotong
切割机



- **Specialized for right angle cutting only**
Khusus untuk pemotongan sudut kanan sahaja
专为右斜角切割而设

Standard Equipment: **Wrench, Hex Wrench**



Continuous Rating Input Input Kuasa Berterusan 额定输入功率	1,300W
Blade Diameter Diameter Bilah 锯片直径	110mm (4-3/8")
Max Cutting Capacity Kapasiti Pemotongan Maksimum 最大切割能力	90°: 32mm (1-1/4")
No Load Speed (RPM) Kelajuan Tanpa Beban 回转数	13,800
Dimensions (L x W x H) Dimensi 体积	227x209x166mm (8-15/16"x8-1/4"x6-1/2")
Net Weight Berat Bersih 净重	2.8kg (6.2lbs)
Power Supply Cord Kabel Wayar 电源线	2.0m (6.6ft.)

4100KB 125mm (5")

303 

Dustless Cutter

Mesin Pemotong
切割机



- **Powerful 1,400W motor, cutting in stone, masonry, tile, concrete & more**
Motor berkuasa 1,400W, untuk memotong batu, masonri, jubin, konkrit dll
强力1,400W马达适合切割石材, 砖石, 瓷砖, 混凝土等

Standard Equipment: **Diamond Wheel (D-38261),
Dust Bag (1267380), Wrench, Hex Wrench**



Continuous Rating Input Input Kuasa Berterusan 额定输入功率	1,400W
Blade Diameter Diameter Bilah 锯片直径	125mm (5")
Max Cutting Capacity Kapasiti Pemotongan Maksimum 最大切割能力	40.0mm (1-9/16")
No Load Speed (RPM) Kelajuan Tanpa Beban 回转数	12,200
Dimensions (L x W x H) Dimensi 体积	231x220x179mm (9-1/8"x8-5/8"x7")
Net Weight Berat Bersih 净重	3.0kg (6.6lbs.)
Power Supply Cord Kabel Wayar 电源线	2.5m (8.2ft.)

4107R 180mm (7-1/8")

153 

Cutter

Mesin Pemotong
切割机



- **Ideal for stone materials (such as granite and marble), concrete and asphalt**
Sesuai untuk bahan batu seperti granit, marma, konkrit dan asphalt bahan
适用于石材如花岗岩, 大理石, 混凝土和沥青

Standard Equipment: **Socket Wrench, Offset Wrench,
Water plug & tube**



Continuous Rating Input Input Kuasa Berterusan 额定输入功率	1,400W
Capacity Kapasiti 能力	Max cutting : 60mm (2-3/8")
Blade Diameter Diameter Bilah 锯片直径	180mm (7-1/8")
No Load Speed (RPM) Kelajuan Tanpa Beban 回转数	5,000
Overall Length Panjang Keseluruhan 总长度	370mm (14-9/16")
Net Weight Berat Bersih 净重	6.3kg (14.5lbs)
Power Supply Cord Kabel Wayar 电源线	5.0m (16.4ft)

CUTTING (Metal)



2107F

Portable Band Saw Pemotong Ringan 带锯机



- **Built-in fluorescent job light for clear view**
Lampu kerja fluoresen terbina dalam untuk penglihatan jelas
内置荧光工作灯，确保清晰视野

ACCESSORIES (Optional)



Portable Band Saw
Stand & Cover
Part No. 196326-7

Standard Equipment:

Band Saw Blade, Hex Wrench



303

Continuous Rating Input Input Kuasa Berterusan 额定输入功率	710W
Capacity Kapasiti 能力	Round: 120mm (4-3/4") Rectangular workpiece w/o stand: 120x120mm (4-3/4"x4-3/4")
Blade Speed Kelajuan Bilah 刀片速度	60m (200ft) - 105m (350ft)/ min
Dimensions (L x W x H) Dimensi 体积	508x188x256mm (20"x7-3/8"x10-1/8")
Net Weight Berat Bersih 净重	6.3kg (13.9lbs)
Power Supply Cord Kabel Wayar 电源线	2.5m (8.2ft)

LW1400 355mm (14")

Portable Cut-off Mesin Pemotong 型材切割机



- **Large spark guard prevents backward scattering of spark**
Pengawal pencucuh menghalang hamburan mundur dari percikan api
大的火花防护装置可防止火花向后散射

Standard Equipment: Abrasive Cut-Off Wheel



203

Continuous Rating Input Input Kuasa Berterusan 额定输入功率	2,200W
Wheel Diameter Diameter Bilah 锯片直径	355mm (14")
No Load Speed (RPM) Kelajuan Tanpa Beban 回转速	3,800
Capacity at 45° Kapasiti 能力	Round: 127mm (5") Rectangular: 115x103mm (4-1/2"x4-1/16") Square: 106x106mm (4-3/16"x4-3/16") Triangular: 100x100x10mm (4"x4"x3/8")
Dimensions (L x W x H) Dimensi 体积	530x295x640mm (20-7/8"x11-5/8"x25-1/4")
Net Weight Berat Bersih 净重	18.7kg (41.2lbs)
Power Supply Cord Kabel Wayar 电源线	2.5m (8.2ft)

LW1401 355mm (14")

Portable Cut-off Mesin Pemotong 型材切割机



- **Powerful 2,200W motor**
Motor berkuasa 2,200W
强力2200W马达

Standard Equipment: Abrasive Cut-Off Wheel, Socket Wrench



203

Continuous Rating Input Input Kuasa Berterusan 额定输入功率	2,200W
Wheel Diameter Diameter Bilah 锯片直径	355mm (14")
No Load Speed (RPM) Kelajuan Tanpa Beban 回转速	3,800
Capacity at 45° Kapasiti 能力	Round: 127mm (5") Rectangular: 115x103mm (4-1/2"x4-1/16") Square: 106x106mm (4-3/16"x4-3/16") Triangular: 100x100x10mm (4"x4"x3/8")
Dimensions (L x W x H) Dimensi 体积	500x295x640mm (19-3/4"x11-5/8"x25-1/4")
Net Weight Berat Bersih 净重	18.3kg (40.3lbs)
Power Supply Cord Kabel Wayar 电源线	2.5m (8.2ft)

Cordless
Timo Acid (TCA)

LED Flashlight
Lampu Suka LED
- LED LIGHT

Vacuum Cleaner
Penyedut Awan
- BLISS

Drilling / Fastening
Dua / Tiga
- 3.3MM - 4.8MM

Impact Drilling / Demolition
Dua / Tiga
- 12.5MM - 18MM

Cutting
Pemotong
- 1/2"

Grinding / Sanding
Tiga / Empat
- 1/2"

Sanding
Dua
- 1/2"

Planing / Routing
Tiga / Empat
- 1/2"

Others
Lain-lain
- 1/2"

Outdoor Power Equipment
Alat Kuasa Luar
- 1/2"

Makita
TIME

CUTTING (Metal)

2416S 405mm (16")

153 W

Portable Cut-off Mesin Pemotong 型材切割机



- **Mitres 45° Left And Right**
Potongan miter 45° kiri dan kanan
左右45° 斜切割

Standard Equipment: Abrasive Cut-Off Wheel, Socket Wrench

Continuous Rating Input Input Kuasa Berterusan 额定输入功率	1,430W
Wheel Diameter Diameter Biliah 锯片直径	405mm (16")
Hole Diameter Diameter Lubang 孔直径	25.4mm (1")
No Load Speed (RPM) Kelajuan Tanpa Beban 回转数	2,300
Dimensions (L x W x H) Dimensi 体积	610x265x535mm (24"x10-3/8"x21")
Net Weight Berat Bersih 净重	19.2kg (42.3lbs)
Power Supply Cord Kabel Wayar 电源线	2.5m (8.2ft)

Model No. 型号	Cutting Angle Sudut Pemotongan 切割角度	Round Pipe Tiub Bulat 圆管	Rectangular Metal Logam Segi Empat Tepat 长方形金属	Square Metal Logam Segi Empat 方形金属	Angle Bar Besi Sudut 角铁
LC1230	90°	115mm	150 x 75mm	100mm	100mm
	45°	90mm	85 x 85mm	85mm	85mm
LW1400	90°	127mm	233 x 70mm	119mm	137mm
	45°	127mm	115 x 103mm	106mm	100mm
LW1401	90°	127mm	233 x 70mm	119mm	137mm
	45°	127mm	115 x 103mm	106mm	100mm
2416S	90°	115mm	230 x 80mm	120mm	150mm
	45°	115mm	110 x 110mm	110mm	110mm

JN1601 1.6mm (16Ga)

411 W

Nibbler Pemotong Elektrik 电冲剪



- **2,200 SPM for faster and smooth cutting**
2,200 SPM untuk pemotongan cepat dan lancar
2200 SPM更快更顺畅地切割

Standard Equipment: Hex Wrench, Wrench, Punch, Die



Continuous Rating Input Input Kuasa Berterusan 额定输入功率	550W
Capacity Kapasiti 能力	Steel up to 400 N/mm ² : 1.6mm Steel up to 600 N/mm ² : 1.2mm Steel up to 800 N/mm ² : 0.8mm Aluminum up to 200 N/mm ² : 2.5mm
Min. Cutting Radius Radius Pemotongan Minimum 最小切割半径	Outside edge : 50mm (2") Inside edge : 45mm (1-3/4")
Strokes Per Minute (SPM) Kelajuan Strok 冲程速度	2,200
Overall Length Panjang Keseluruhan 总长度	261mm (10-1/4")
Net Weight Berat Bersih 净重	1.6kg (3.6lbs)
Power Supply Cord Kabel Wayar 电源线	2.0m (6.6ft)

JN3201 3.2mm (10Ga)

303 W

Nibbler Pemotong Elektrik 电冲剪



- **Built-in thickness gauge for operator convenience**
Penyukat ketebalan terbina dalam memudahkan pengguna
内置测厚仪方便使用

Standard Equipment: Punch, Die, Wrench 50, Hex Wrench, Washer



Continuous Rating Input Input Kuasa Berterusan 额定输入功率	710W
Capacity Kapasiti 能力	Steel up to 400 N/mm ² : 3.2mm Steel up to 600 N/mm ² : 2.5mm Steel up to 800 N/mm ² : 1.0mm Aluminum up to 200 N/mm ² : 3.5mm
Min. Cutting Radius Radius Pemotongan Minimum 最小切割半径	Outside edge : 128mm (5-1/16") Inside edge : 120mm (4-3/4")
Strokes Per Minute (SPM) Kelajuan Strok 冲程速度	1,300
Dimensions (L x W x H) Dimensi 体积	225x90x254mm (8-7/8"x1-1/2"x10")
Net Weight Berat Bersih 净重	3.4kg (7.4lbs)
Power Supply Cord Kabel Wayar 电源线	2.5m (8.2ft)

Cordless
Tanpa Kord Daya

LED Flashlight
Lampu Sinar LED
LEO-00007

Vacuum Cleaner
Penyedut Debu
VAC-00001

Drilling / Fastening
Drool / Pasang
DRO-00001

Impact Drilling / Demolition
Drool / Pecah
DRO-00002

Cutting
Pemotong
CUT-00001

Grinding / Sanding
Finishing / Polish
GRI-00001

Sawing
Gigit
SAW-00001

Planing / Routing
Pengaliran / Tampang
PLA-00001

Others
Lain-lain
OTR-00001

Outdoor Power Equipment
Alat Kuasa Luar
OPE-00001

Makita
MAKITA

CUTTING (Metal)

JS1601 1.6mm (16Ga)

459

Straight Metal Shear Pemotong Elektrik 电剪刀



- **Fast Cutting Action in Steel and Aluminum**
Pemotongan Cepat untuk Keluli dan Aluminium
快速切割钢和铝



Standard Equipment: Hex Wrench, Thickness Gauge



Continuous Rating Input Input Kuasa Berterusan 额定输入功率	380W
Capacity Kapasiti 能力	Steel up to 400N/mm ² : 1.6mm Steel up to 600N/mm ² : 1.2mm Steel up to 800N/mm ² : 0.8mm Aluminum up to 200N/mm ² : 2.5mm 250mm (9-7/8")
Min. Cutting Radius Radius Pemotongan Minimum 最小切割半径	
Strokes Per Minute (SPM) Kelajuan Strok 冲程速度	4,500
Dimensions (L x W x H) Dimensi 体积	320x70x78mm (12-5/8"x2-3/4"x3-1/16")
Net Weight Berat Bersih 净重	1.4kg (3.2lbs)
Power Supply Cord Kabel Wayar 电源线	2.5m (8.2ft)

JS1300 1.3mm

419

Straight Shear Pemotong Elektrik 电剪刀



- **Shear head attachment rotates 360°**
Kepala pemotong boleh berputar 360°
剪切头附件可旋转360°



Standard Equipment: Hex Wrench



Continuous Rating Input Input Kuasa Berterusan 额定输入功率	570W
Capacity Kapasiti 能力	Steel up to 400N/mm ² : 1.3mm Steel up to 600N/mm ² : 1.0mm Steel up to 800N/mm ² : 0.5mm Aluminum up to 200N/mm ² : 2.5mm 0-2,500
Strokes Per Minute (SPM) Kelajuan Strok 冲程速度	
Overall Length Panjang Keseluruhan 总长度	302mm (11-7/8")
Net Weight Berat Bersih 净重	1.8kg (3.9lbs)
Power Supply Cord Kabel Wayar 电源线	2.5m (8.2ft)

JS1602 1.6mm (16Ga)

459

Metal Shear Pemotong Elektrik 电剪刀



- **Fast and efficient cutting**
Pemotongan cepat dan cekap
快速高效的切割



Standard Equipment: Hex Wrench, Shear Blade Set



Continuous Rating Input Input Kuasa Berterusan 额定输入功率	380W
Capacity Kapasiti 能力	Steel up to 400N/mm ² : 1.6mm Steel up to 600N/mm ² : 1.2mm Steel up to 800N/mm ² : 0.8mm Aluminum up to 200N/mm ² : 2.5mm 30mm (1-3/16")
Min. Cutting Radius Radius Pemotongan Minimum 最小切割半径	
Strokes Per Minute (SPM) Kelajuan Strok 冲程速度	4,000
Dimensions (L x W x H) Dimensi 体积	255x74x146mm (10"x2-15/16"x5-3/4")
Net Weight Berat Bersih 净重	1.6kg (3.4lbs)
Power Supply Cord Kabel Wayar 电源线	2.5m (8.2ft)

JS3201 3.2mm (10Ga)

303

Metal Shear Pemotong Elektrik 电剪刀



- **Powerful 710W Motor**
Motor berkuasa 710W
强力710W马达



Standard Equipment: Shear Blade Set, Hex Wrench,
Thickness Gauge



Continuous Rating Input Input Kuasa Berterusan 额定输入功率	710W
Capacity Kapasiti 能力	Steel up to 400N/mm ² : 3.2mm Steel up to 600N/mm ² : 2.5mm Steel up to 800N/mm ² : 1.5mm Aluminum up to 200N/mm ² : 4.0mm 50mm (2")
Min. Cutting Radius Radius Pemotongan Minimum 最小切割半径	
Strokes Per Minute (SPM) Kelajuan Strok 冲程速度	1,600
Dimensions (L x W x H) Dimensi 体积	213x90x239mm (8-3/8"x3-1/2"x9-3/8")
Net Weight Berat Bersih 净重	3.4kg (7.5lbs)
Power Supply Cord Kabel Wayar 电源线	2.5m (8.2ft)

CA5000X 118mm (4-5/8")

303

Aluminum Groove Cutter Mesin Memotong Aluminium 铝板开槽切割机



- **Cutter blade for 135 degrees V shaped groove as an option**
Bilah pemotong alur 135° berbentuk V pemilihan
可选135° V形槽的锯片



Standard Equipment: Cutter Blade, Plate, Hex Wrench

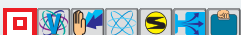

Continuous Rating Input Input Kuasa Berterusan 额定输入功率	1,300W
Blade Bilah 锯片	Type: Cutter blade/ TCT saw blade
Max Cutting Capacity w/ Cutter blade Kapasiti Pemotongan Maksimum 最大切割能力	w/ Guide rail: 11mm (7/16")
Max Cutting Capacity w/ TCT Saw blade Kapasiti Pemotongan Maksimum 最大切割能力	w/ Guide rail: 36mm (1-7/16") w/o Guide rail: 41mm (1-5/8") 2,200-6,400
No Load Speed (RPM) Kelajuan Tanpa Beban 回转数	
Dimensions (L x W x H) Dimensi 体积	346x250x250mm (13-5/8"x9-7/8"x9-7/8")
Net Weight Berat Bersih 净重	4.7kg (10.4lbs)
Power Supply Cord Kabel Wayar 电源线	2.5m (8.2ft)

Cordless
Tengo Acid (RCS)LED Flashlight
Tengo Flash, LED
- LCOB001TVacuum Cleaner
Tengo Vaccum
- BL001Drilling / Fastening
Tengo Drill, T
- BL001Impact Drilling / Demolition
Tengo Impact
- BL001Cutting / Planing
Tengo Cut
- BL001Grinding / Sanding
Tengo Grind
- BL001Sawing
Tengo Saw
- BL001Planing / Routing
Tengo Plan
- BL001Others
Tengo Other
- BL001Outdoor Power Equipment
Tengo Outdoor
- BL001Makita
- BL001Makita
- BL001

GRINDING SANDING

Pengisar | Pelicin 研削 | 研磨



9553HNG 100mm (4")

325

Angle Grinder
Pengisar Sudut
角向磨光机



Slide Switch
Suis Gelangsar 滑动开关

- **Spiral bevel gears for smoother rotations**
Gear serong lingkaran untuk putaran yang licin
螺旋锥齿轮更平滑的旋转



Standard Equipment: Depressed Center Wheel (A-80852), Side Grip, Wheel Cover, Lock Nut Wrench



Continuous Rating Input Input Kuasa Berterusan 额定输入功率	710W
Wheel Diameter Diameter Roda 轮片直径	100mm (4")
No Load Speed (RPM) Kelajuan Tanpa Beban 回转数	11,000
Dimensions (L x W x H) Dimensi 体积	258x118x97mm (10-1/8"x4-5/8"x3-13/16")
Net Weight Berat Bersih 净重	1.5 - 1.8kg (3.2 - 4.1lbs)
Power Supply Cord Kabel Wayar 电源线	2.5m (8.2ft.)

9553HBG 100mm (4")

325

Angle Grinder
Pengisar Sudut
角向磨光机



Toggle Switch
Suis Togol 后盖式开关

- **Compact design and lightweight**
Reka bentuk padat dan ringan
设计紧凑，轻量



Standard Equipment: Depressed Center Wheel (A-80852), Wheel Cover, Lock Nut Wrench



Continuous Rating Input Input Kuasa Berterusan 额定输入功率	710W
Wheel Diameter Diameter Roda 轮片直径	100mm (4")
No Load Speed (RPM) Kelajuan Tanpa Beban 回转数	11,000
Dimensions (L x W x H) Dimensi 体积	258x118x97mm (10-1/8"x4-5/8"x3-13/16")
Net Weight Berat Bersih 净重	1.5 - 1.9kg (3.3 - 4.1lbs)
Power Supply Cord Kabel Wayar 电源线	2.5m (8.2ft.)

GA4030R 100mm (4")

459

Angle Grinder
Pengisar Sudut
角向磨光机



Slide Switch
Suis Gelangsar 滑动开关

- **Machined bevel gears provide up to 2x longer service life**
Gear bevel machined mempanjangkan hayat penggunaan 2x lebih lama
加工锥齿轮延长了长达 2x 的使用寿命



Standard Equipment: Depressed Center Wheel (A-80852), Side Grip, Wheel Cover, Lock Nut Wrench



Continuous Rating Input Input Kuasa Berterusan 额定输入功率	720W
Wheel Diameter Diameter Roda 轮片直径	100mm (4")
No Load Speed (RPM) Kelajuan Tanpa Beban 回转数	11,000
Dimensions (L x W x H) Dimensi 体积	266x118x102mm (10-1/2"x4-5/8"x4")
Net Weight Berat Bersih 净重	1.72 - 2.01kg (3.79 - 4.43lbs)
Power Supply Cord Kabel Wayar 电源线	2.5m (8.2ft)

Cordless
Terdapat Tanpa Kabel

LED Flashlight
Lampu Sinar LED
LED 照明灯

Vacuum Cleaner
Penyedut Vakuum
吸尘器

Drilling / Fastening
Drool / Pasangkan
钻孔 / 紧固

Impact Drilling / Demolition
Drool / Hancurkan
冲击钻孔 / 拆除

Cutting / Finishing
Potong / Finishing
切割 / 打磨

Grinding / Sanding
Pegras / Pasir
研磨 / 打磨

Sawing / Double
Gergaji / Double
锯切 / 双刃

Planing / Routing
Pencap / Rutekan
刨平 / 开槽

Others
Lain-lain
其他

Outdoor Power Equipment
Alat Kuasa Luar
户外动力设备



GRINDING | SANDING

GA4030 100mm (4")

459 mm

Angle Grinder Pengisar Sudut 角向磨光机

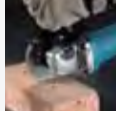

Slide Switch

Suis Gelangsar 滑动开关

- **All ball bearing construction for durability and longer tool life**
Struktur gelas bola untuk memanjangkan hayat alat
滚珠轴承结构延长工具寿命



Standard Equipment: Depressed Center Wheel (A-80852), Side Grip, Wheel Cover, Lock Nut Wrench



Continuous Rating Input Input Kuasa Berterusan 额定输入功率	720W
Wheel Diameter Diameter Roda 轮片直径	100mm (4")
No Load Speed (RPM) Kelajuan Tanpa Beban 回转数	11,000
Dimensions (L x W x H) Dimensi 体积	266x117x95mm (10-1/2"x4-5/8"x3-3/4")
Net Weight Berat Bersih 净重	1.73 - 2.02kg (3.81 - 4.45lbs)
Power Supply Cord Kabel Wayar 电源线	2.5m (8.2ft)

GA4031 100mm (4")

459 mm

Angle Grinder Pengisar Sudut 角向磨光机



Toggle Switch

Suis Togol 后置式开关

- **Toggle switch for easy operation**
Suis togol untuk operasi lebih mudah
后置式开关方便操作



Standard Equipment: Depressed Center Wheel (A-80852), Wheel Cover, Lock Nut Wrench



Continuous Rating Input Input Kuasa Berterusan 额定输入功率	720W
Wheel Diameter Diameter Roda 轮片直径	100mm (4")
No Load Speed (RPM) Kelajuan Tanpa Beban 回转数	11,000
Dimensions (L x W x H) Dimensi 体积	259x118x104mm (10-1/4"x4-5/8"x4-1/8")
Net Weight Berat Bersih 净重	1.71 - 2.00kg (3.77 - 4.41lbs)
Power Supply Cord Kabel Wayar 电源线	2.5m (8.2ft)

GA4034 100mm (4")

459 mm

Angle Grinder Pengisar Sudut 角向磨光机



Paddle Switch

Suis Pemacu 扳机开关

- **Machined bevel gears provide up to 2x longer service life**
Gear bevel machined memanjangkan hayat penggunaan 2x lebih lama
加工锥齿轮延长了长达 2x 的使用寿命



Standard Equipment: Depressed Center Wheel (A-80852), Side Grip, Wheel Cover, Lock Nut Wrench



Continuous Rating Input Input Kuasa Berterusan 额定输入功率	720W
Wheel Diameter Diameter Roda 轮片直径	100mm (4")
No Load Speed (RPM) Kelajuan Tanpa Beban 回转数	11,000
Dimensions (L x W x H) Dimensi 体积	265x118x95mm (10-3/8"x4-5/8"x3-3/4")
Net Weight Berat Bersih 净重	1.77 - 2.06kg (3.90 - 4.54lbs)
Power Supply Cord Kabel Wayar 电源线	2.5m (8.2ft)

9556HNG / HN / NB 100mm (4")

325 mm

Angle Grinder Pengisar Sudut 角向磨光机



Slide Switch

Suis Gelangsar 滑动开关

- **Powerful 840W motor**
Motor berkuasa 840W
强力840W马达



Standard Equipment: Depressed Center Wheel (A-80852), Side Grip, Wheel Cover, Lock Nut Wrench



Continuous Rating Input Input Kuasa Berterusan 额定输入功率	840W
Wheel Diameter Diameter Roda 轮片直径	100mm (4")
No Load Speed (RPM) Kelajuan Tanpa Beban 回转数	11,000
Dimensions (L x W x H) Dimensi 体积	271x118x97mm (10-5/8"x4-5/8"x3-13/16")
Net Weight Berat Bersih 净重	1.6 - 2.0kg (3.6 - 4.4lbs)
Power Supply Cord Kabel Wayar 电源线	2.5m (8.2ft)

9556HPG / PB 100mm (4")

325 mm

Angle Grinder Pengisar Sudut 角向磨光机



Paddle Switch

Suis Pemacu 扳机开关

- **Powerful 840W motor**
Motor berkuasa 840W
强力840W马达



Standard Equipment: Depressed Center Wheel (A-80852), Side Grip, Wheel Cover, Lock Nut Wrench



Continuous Rating Input Input Kuasa Berterusan 额定输入功率	840W
Wheel Diameter Diameter Roda 轮片直径	100mm (4")
No Load Speed (RPM) Kelajuan Tanpa Beban 回转数	11,000
Dimensions (L x W x H) Dimensi 体积	273x118x97mm (10-3/4"x4-5/8"x3-13/16")
Net Weight Berat Bersih 净重	1.6 - 2.0kg (3.6 - 4.5lbs)
Power Supply Cord Kabel Wayar 电源线	2.5m (8.2ft)

Cordless
Tali Wayar Tanpa WayarLED Flashlight
Lampu Sinar LED
- LED BERTAMBAHVacuum Cleaner
Penyedut Debu
- BUKUDrilling / Fastening
Cairan / Pasukan
- BUKU / BUKUImpact Drilling / Demolition
Cairan / Pasukan
- BUKU / BUKUCutting / Grinding
Pemotong / Pengkilat
- BUKUGrinding / Sanding
Pengkilat / Pengkilat
- BUKU / BUKUSawing / Daging
Daging / Daging
- BUKUPlaning / Roosting
Pengkilat / Pengkilat
- BUKU / BUKUOthers
Lain-lain
- BUKUOutdoor Power Equipment
Alatan Kuasa Luar
- BUKU / BUKUMakita
- BUKU

GRINDING | SANDING

Cordless
Tahan Bantut Baki

LED Flashlight
Lampu Sinar LED
1.6000000

Vacuum Cleaner
Penyedut Vakuum
1.0000000

Drilling / Fastening
Borok / Pasang
1.0000000

Impact Drilling / Demolition
Borok / Demolisi
1.0000000

Cutting
Memotong
1.0000000

Grinding / Sanding
Pergilas / Pasir
1.0000000

Sawing
Dobok
1.0000000

Planing / Routing
Pencabok / Rutek
1.0000000

Others
Lain-lain
1.0000000

Outdoor Power Equipment
Alat Kuasa Luar
1.0000000

Makita
1.0000000

GA4040 100mm (4") 325 W

Angle Grinder
Pengisar Sudut
角向磨光机



Slide Switch
Suis Gelangsar 滑动开关



- **Spiral bevel gears for smoother rotations and a more efficient transfer of energy**
gear serong lingkaran untuk pemindahan tenaga yang lebih cekap
螺旋锥齿轮高效输送能源

Standard Equipment: Depressed Center Wheel (A-80852), Side Grip, Wheel Cover, Lock Nut Wrench



Continuous Rating Input Input Kuasa Berterusan 额定输入功率	1,100W
Wheel Diameter Diameter Roda 轮片直径	100mm (4")
No Load Speed (RPM) Kelajuan Tanpa Beban 回转数	11,000
Dimensions (L x W x H) Dimensi 体积	303x117x111mm (11-7/8"x4-5/8"x4-3/8")
Net Weight Berat Bersih 净重	2.2 - 2.5kg (4.9 - 5.6lbs)
Power Supply Cord Kabel Wayar 电源线	2.5m (8.2ft)

GA4051R 100mm (4") 260 W

Angle Grinder
Pengisar Sudut
角向磨光机



Paddle Switch
Suis Pemacu 扳机开关



- **Powerful 1,300W motor delivers 11,000RPM for high output power**

Standard Equipment: Side Grip, Wheel Cover, Lock Nut Wrench



Continuous Rating Input Input Kuasa Berterusan 额定输入功率	1,300W
Wheel Diameter Diameter Roda 轮片直径	100mm (4")
Wheel Hole Diameter Diameter Lubang Roda 轮片孔直径	16mm (5/8")
Max Wheel Thickness Ketebalan Roda Maksimum 最大轮片厚度	6.4mm (1/4")
No Load Speed (RPM) Kelajuan Tanpa Beban 回转数	11,000
Dimensions (L x W x H) Dimensi 体积	325x117x100mm (12-3/4"x4-5/8"x4-5/8")
Net Weight Berat Bersih 净重	2.3 - 2.5kg (5.1 - 5.5lbs.)
Power Supply Cord Kabel Wayar 电源线	2.5m (8.2ft)

GA4041C 100mm (4") 318 W

Angle Grinder
Pengisar Sudut
角向磨光机



Slide Switch
Suis Gelangsar 滑动开关



- **Super Joint System II developed for effective vibration absorption**
SJS generasi kedua berkesan untuk menyerap getaran
第二代 SJS 有效抑止震动

Standard Equipment: Depressed Center Wheel (A-80852), Side Grip, Wheel Cover, Lock Nut Wrench



Continuous Rating Input Input Kuasa Berterusan 额定输入功率	1,400W
Wheel Diameter Diameter Roda 轮片直径	100mm (4")
No Load Speed (RPM) Kelajuan Tanpa Beban 回转数	2,800-11,000
Dimensions (L x W x H) Dimensi 体积	325x117x117mm (12-3/4"x4-5/8"x4-5/8")
Net Weight Berat Bersih 净重	2.5 - 2.8kg (5.6 - 6.2lbs)
Power Supply Cord Kabel Wayar 电源线	2.5m (8.2ft)

GA4040C 100mm (4") 318 W

Angle Grinder
Pengisar Sudut
角向磨光机



Slide Switch
Suis Gelangsar 滑动开关



- **Super Joint System II developed for effective vibration absorption**
SJS generasi kedua berkesan untuk menyerap getaran
第二代 SJS 有效抑止震动

Standard Equipment: Depressed Center Wheel (A-80852), Side Grip, Wheel Cover, Lock Nut Wrench



Continuous Rating Input Input Kuasa Berterusan 额定输入功率	1,400W
Wheel Diameter Diameter Roda 轮片直径	100mm (4")
No Load Speed (RPM) Kelajuan Tanpa Beban 回转数	2,800-11,000
Dimensions (L x W x H) Dimensi 体积	303x117x111mm (11-7/8"x4-5/8"x4-3/8")
Net Weight Berat Bersih 净重	2.3 - 2.6kg (5.1 - 5.7lbs)
Power Supply Cord Kabel Wayar 电源线	2.5m (8.2ft)

9563C 100mm (4") 318 W

Angle Grinder
Pengisar Sudut
角向磨光机



Slide Switch
Suis Gelangsar 滑动开关



- **High power anti-dust motor**
Motor tahan debu tinggi
大功率防尘马达

Standard Equipment: Depressed Center Wheel (D-18443), Side Grip, Wheel Cover, Lock Nut Wrench



Continuous Rating Input Input Kuasa Berterusan 额定输入功率	1,400W
Wheel Diameter Diameter Roda 轮片直径	100mm (4")
No Load Speed (RPM) Kelajuan Tanpa Beban 回转数	12,000
Overall Length Dimensi 体积	299mm (11-3/4")
Net Weight Berat Bersih 净重	2.1kg (4.6lbs)
Power Supply Cord Kabel Wayar 电源线	2.5m (8.2ft)

GRINDING | SANDING



GA4530 115mm (4-1/2")

459

Angle Grinder Pengisar Sudut 角向磨光机



Slide Switch

Suis Gelangsar 滑动开关

- **Small diameter barrel grip for added comfort**
Genggaman barel diameter kecil meningkatkan keselesaan
小直径桶形手柄，增加手握舒适度



Standard Equipment: Depressed Center Wheel (A-80640), Side Grip, Wheel Cover, Lock Nut Wrench



Continuous Rating Input Input Kuasa Berterusan 额定输入功率	720W
Wheel Diameter Diameter Roda 轮片直径	115mm (4-1/2")
No Load Speed (RPM) Kelajuan Tanpa Beban 回转数	11,000
Dimensions (L x W x H) Dimensi 体积	266x128x103mm (10-1/2"x5"x4-1/16")
Net Weight Berat Bersih 净重	1.89 - 2.23kg (4.17 - 4.91lbs)
Power Supply Cord Kabel Wayar 电源线	2.5m (8.2ft)

GA4530R 115mm (4-1/2")

459

Angle Grinder Pengisar Sudut 角向磨光机



Slide Switch

Suis Gelangsar 滑动开关

- **Anti-restart function prevents accidental start-up**
Fungsi anti-restart menghalang penghidupan yang tidak disengajakan
防重启功能可防止意外启动



Standard Equipment: Depressed Center Wheel (A-80640), Side Grip, Wheel Cover, Lock Nut Wrench



Continuous Rating Input Input Kuasa Berterusan 额定输入功率	720W
Wheel Diameter Diameter Roda 轮片直径	115mm (4-1/2")
No Load Speed (RPM) Kelajuan Tanpa Beban 回转数	11,000
Dimensions (L x W x H) Dimensi 体积	266x130x108mm (10-1/2"x5-1/2"x4-1/4")
Net Weight Berat Bersih 净重	1.88 - 2.22kg (4.14 - 4.89lbs)
Power Supply Cord Kabel Wayar 电源线	2.5m (8.2ft)

9557HNG / NBG 115mm (4-1/2")

325

Angle Grinder Pengisar Sudut 角向磨光机



Slide Switch

Suis Gelangsar 滑动开关

- **Powerful 840W motor**
Motor berkuasa 840W
强力840W马达



Standard Equipment: Depressed Center Wheel, Side Grip, Wheel Cover, Lock Nut Wrench



Continuous Rating Input Input Kuasa Berterusan 额定输入功率	840W
Wheel Diameter Diameter Roda 轮片直径	115mm (4-1/2")
No Load Speed (RPM) Kelajuan Tanpa Beban 回转数	11,000
Dimensions (L x W x H) Dimensi 体积	271x129x106mm (10-5/8"x5-1/8"x4-3/16")
Net Weight Berat Bersih 净重	1.7 - 2.2kg (3.8 - 4.8lbs)
Power Supply Cord Kabel Wayar 电源线	2.5m (8.2ft)

9557HPG 115mm (4-1/2")

325

Angle Grinder Pengisar Sudut 角向磨光机



Paddle Switch

Suis Pemacu 扳机开关

- **Large Flush-Mount Paddle Switch for Comfortable Operation**
Suis Flush-mount mudah digunakan
大型平装式扳机开关易于操作



Standard Equipment: Depressed Center Wheel, Side Grip, Wheel Cover, Lock Nut Wrench



Continuous Rating Input Input Kuasa Berterusan 额定输入功率	840W
Wheel Diameter Diameter Roda 轮片直径	115mm (4-1/2")
No Load Speed (RPM) Kelajuan Tanpa Beban 回转数	11,000
Dimensions (L x W x H) Dimensi 体积	273x129x106mm (10-3/4"x5-1/8"x4-3/16")
Net Weight Berat Bersih 净重	1.8 - 2.2kg (3.9 - 4.8lbs)
Power Supply Cord Kabel Wayar 电源线	2.5m (8.2ft)

Cordless
Terdapat dalam siriLED Flashlight
Lampu Sulu LED
LED BERTAMBAHVacuum Cleaner
Penyedut Debu
VACUUMDrilling / Fastening
Cairan / Pasukan
MIL / 釘Impact Drilling / Demolition
Cairan / Pasukan
GAMPAK / 破壞Cutting / Grinding
Pemotong / Giling
GUPGrinding / Sanding
Pengisar / Pasukan
GUP / 砂Sawing
Dagang
GUPPlaning / Routing
Pengukir / Pasukan
GUP / 釘Others
Lain-lain
GUPOutdoor Power Equipment
Alatan Peralatan Luar
GUP / 釘Makita
TAMBAH

GRINDING | SANDING

Cordless
Tethered About 18.42"

LED Flashlight
Lampu Sinar LED
1.6000000

Vacuum Cleaner
Penyedot Debu
1.000000

Drilling / Fastening
Drooi / Pasang
1.000000

Impact Drilling / Demolition
Drooi / Demolisi
1.000000

Cutting / Finishing
Potong / Finishing
1.000000

Grinding / Sanding
Pigral / Pasrah
1.000000

Sawing
Drooi
1.000000

Planing / Routing
Pengaliran / Rute
1.000000

Others
Lain-lain
1.000000

Outdoor Power Equipment
Alat-alat Tenaga Luar
1.000000

Makita
1.000000

GA4540R 115mm (4-1/2")

325 W

Angle Grinder
Pengisar Sudut
角向磨光机



Slide Switch
Suis Gelangsar 滑动开关

• **Super Joint System II developed for effective vibration absorption**
SJS generasi kedua berkesan untuk menyerap getaran
第二代 SJS 有效抑止震动

Standard Equipment: Depressed Center Wheel (A-80640), Side Grip, Wheel Cover, Lock Nut Wrench



Continuous Rating Input Input Kuasa Berterusan 额定输入功率	1,100W
Wheel Diameter Diameter Roda 轮片直径	115mm (4-1/2")
No Load Speed (RPM) Kelajuan Tanpa Beban 回转速数	11,000
Dimensions (L x W x H) Dimensi 体积	303x130x116mm (11-7/8"x5-1/8"x4-9/16")
Net Weight Berat Bersih 净重	2.4 - 2.8kg (5.4 - 6.1lbs)
Power Supply Cord Kabel Wayar 电源线	2.5m (8.2ft)

GA4540 115mm (4-1/2")

325 W

Angle Grinder
Pengisar Sudut
角向磨光机



Slide Switch
Suis Gelangsar 滑动开关

• **Super Joint System II developed for effective vibration absorption**
SJS generasi kedua berkesan untuk menyerap getaran
第二代 SJS 有效抑止震动

Standard Equipment: Depressed Center Wheel (A-80640), Side Grip, Wheel Cover, Lock Nut Wrench



Continuous Rating Input Input Kuasa Berterusan 额定输入功率	1,100W
Wheel Diameter Diameter Roda 轮片直径	115mm (4-1/2")
No Load Speed (RPM) Kelajuan Tanpa Beban 回转速数	11,000
Dimensions (L x W x H) Dimensi 体积	303x130x116mm (11-7/8"x5-1/8"x4-9/16")
Net Weight Berat Bersih 净重	2.3 - 2.7kg (5.2 - 5.9lbs)
Power Supply Cord Kabel Wayar 电源线	2.5m (8.2ft)

GA4541C 115mm (4-1/2")

318 W

Angle Grinder
Pengisar Sudut
角向磨光机



Slide Switch
Suis Gelangsar 滑动开关

• **Super Joint System II developed for effective vibration absorption**
SJS generasi kedua berkesan untuk menyerap getaran
第二代 SJS 有效抑止震动

Standard Equipment: Depressed Center Wheel (D-18459), Side Grip, Wheel Cover, Lock Nut Wrench



Continuous Rating Input Input Kuasa Berterusan 额定输入功率	1,400W
Wheel Diameter Diameter Roda 轮片直径	115mm (4-1/2")
No Load Speed (RPM) Kelajuan Tanpa Beban 回转速数	2,800-11,000
Dimensions (L x W x H) Dimensi 体积	325x130x121mm (12-3/4"x5-1/8"x4-3/4")
Net Weight Berat Bersih 净重	2.7 - 3.0kg (5.9 - 6.7lbs)
Power Supply Cord Kabel Wayar 电源线	2.5m (8.2ft)



GA5030 125mm (5")

459 W

Angle Grinder
Pengisar Sudut
角向磨光机



Slide Switch
Suis Gelangsar 滑动开关

• **Machined bevel gears provide up to 2x longer service life**
Gear bevel machined memanjangkan hayat penggunaan 2x lebih lama
加工锥齿轮延长了长达 2x 的使用寿命

Standard Equipment: Depressed Center Wheel (A-80656), Side Grip, Wheel Cover, Lock Nut Wrench



Continuous Rating Input Input Kuasa Berterusan 额定输入功率	720W
Wheel Diameter Diameter Roda 轮片直径	125mm (5")
No Load Speed (RPM) Kelajuan Tanpa Beban 回转速数	11,000
Dimensions (L x W x H) Dimensi 体积	266x138x103mm (10-1/2"x5-7/16"x4-1/16")
Net Weight Berat Bersih 净重	1.92 - 3.07kg (4.23 - 6.77lbs)
Power Supply Cord Kabel Wayar 电源线	2.5m (8.2ft)

GRINDING | SANDING

GA5030R 125mm (5")

459

Angle Grinder Pengisar Sudut 角向磨光机



Slide Switch

Suis Gelangsar 滑动开关

- **Anti-restart function prevents accidental start-up**
Fungsi anti-restart menghalang penghidupan yang tidak disengajakan
防重启功能可防止意外启动

Standard Equipment: Depressed Center Wheel (A-80656), Side Grip, Wheel Cover, Lock Nut Wrench



Continuous Rating Input Input Kuasa Berterusan 额定输入功率	720W
Wheel Diameter Diameter Roda 轮片直径	125mm (5")
No Load Speed (RPM) Kelajuan Tanpa Beban 回转数	11,000
Dimensions (L x W x H) Dimensi 体积	266x140x108mm (10-1/2"x5-1/2"x4-1/4")
Net Weight Berat Bersih 净重	1.91 - 3.06kg (4.21 - 6.75lbs)
Power Supply Cord Kabel Wayar 电源线	2.5m (8.2ft)

GA5034 125mm (5")

459

Angle Grinder Pengisar Sudut 角向磨光机



Paddle Switch

Suis Pemacu 扳机开关

- **Small Diameter Barrel Grip**
Genggaman Barel Diameter Kecil
小直径桶握

Standard Equipment: Depressed Center Wheel (A-80656), Side Grip, Wheel Cover, Lock Nut Wrench



Continuous Rating Input Input Kuasa Berterusan 额定输入功率	720W
Wheel Diameter Diameter Roda 轮片直径	125mm (5")
No Load Speed (RPM) Kelajuan Tanpa Beban 回转数	11,000
Dimensions (L x W x H) Dimensi 体积	265x139x103mm (10-3/8"x5-1/2"x4-1/16")
Net Weight Berat Bersih 净重	2.00 - 3.15kg (4.41 - 6.94lbs)
Power Supply Cord Kabel Wayar 电源线	2.5m (8.2ft)

9558HNG / NBG 125mm (5")

325

Angle Grinder Pengisar Sudut 角向磨光机



Slide Switch

Suis Gelangsar 滑动开关

- **Slide switch with lock-on for continuous use**
Suis gelangsar dengan fungsi mengunci untuk kegunaan berterusan
备有锁定功能的滑动按钮可连续无间断的使用

Standard Equipment: Depressed Center Wheel, Side Grip, Wheel Cover, Lock Nut Wrench



Continuous Rating Input Input Kuasa Berterusan 额定输入功率	840W
Wheel Diameter Diameter Roda 轮片直径	125mm (5")
No Load Speed (RPM) Kelajuan Tanpa Beban 回转数	11,000
Dimensions (L x W x H) Dimensi 体积	271x139x106mm (10-5/8"x5-1/2"x4-3/16")
Net Weight Berat Bersih 净重	1.7 - 3.2kg (3.8 - 6.6lbs)
Power Supply Cord Kabel Wayar 电源线	2.5m (8.2ft)

9558HPG 125mm (5")

325

Angle Grinder Pengisar Sudut 角向磨光机



Paddle Switch

Suis Pemacu 扳机开关

- **Large Flush-Mount Paddle Switch for Comfortable Operation**
Suis Flush-mount mudah digunakan
大型平装式扳机开关易于操作

Standard Equipment: Depressed Center Wheel, Side Grip, Wheel Cover, Lock Nut Wrench



Continuous Rating Input Input Kuasa Berterusan 额定输入功率	840W
Wheel Diameter Diameter Roda 轮片直径	125mm (5")
No Load Speed (RPM) Kelajuan Tanpa Beban 回转数	11,000
Dimensions (L x W x H) Dimensi 体积	273x139x106mm (10-3/4"x5-1/2"x4-3/16")
Net Weight Berat Bersih 净重	1.8 - 3.0kg (3.9 - 6.7lbs)
Power Supply Cord Kabel Wayar 电源线	2.5m (8.2ft)

GA5020 125mm (5")

303

Angle Grinder Pengisar Sudut 角向磨光机



Trigger Switch

Suis Pemacu 扳机开关

- **SJS Mechanical Clutch System Helps Prevent Motor and Gear Damage**
Sistem SJS mencegah kerosakan pada motor dan gear
SJS 系统有助于防止马达和齿轮损坏

Standard Equipment: Depressed Center Wheel (A-80656), Side Grip, Wheel Cover, Lock Nut Wrench



Continuous Rating Input Input Kuasa Berterusan 额定输入功率	1,050W
Wheel Diameter Diameter Roda 轮片直径	125mm (5")
No Load Speed (RPM) Kelajuan Tanpa Beban 回转数	12,000
Dimensions (L x W x H) Dimensi 体积	356x139x120mm (14"x5-1/2"x4-3/4")
Net Weight Berat Bersih 净重	2.7 - 3.9kg (6.0 - 8.6lbs)
Power Supply Cord Kabel Wayar 电源线	2.5m (8.2ft)

Cordless
Tali Wayar BebasLED Flashlight
Lampu Sulu LED
LED BERTAMBAHVacuum Cleaner
Penyedut Debu
VACUUMDrilling / Fastening
Cairan / Pasukan
MIL / 螺絲Impact Drilling / Demolition
Cairan / Pasukan
GAMPAK / 破壞Cutting / Grinding
Pemotong
GAMPAKGrinding / Sanding
Pengisar / Pasukan
GAMPAKSawing / Daging
GAMPAKPlaning / Roasting
Pengisar / Pasukan
GAMPAKOthers
Lain-lain
GAMPAKOutdoor Power Equipment
Alatan Peralatan Luar
GAMPAKMakita
TAMBAH

GRINDING | SANDING

Cordless
Tethered Cordless
LED Flashlight
Lampu Sinar LED
1.6000000
Vacuum Cleaner
Pembersih Vakum
MUSK
Drilling / Fastening
Borasi / Pasang
MUTU / 螺母
Impact Drilling / Demolition
Borasi / Demolisi
MUTU / 螺母
Cutting / Removing
Potong / Hilangkan
MUTU / 螺母
Grinding / Sanding
Pergilas / Sanding
MUTU / 螺母
Sawing / Double
Gergaji / Gergaji
MUTU / 螺母
Planing / Routing
Pencap / Rutekan
MUTU / 螺母
Others
Lain-lain
MUTU / 螺母
Outdoor Power Equipment
Alat-alat Tenaga Luar
MUTU / 螺母
Makita
MUTU / 螺母

GA5010 125mm (5")

303

Angle Grinder Pengisar Sudut 角向磨光机



Trigger Switch Suis Pemicu 扳机开关



- **Powerful 1,050W motor**
Motor berkuasa 1,050W
强力1,050W马达

Standard Equipment: Depressed Center Wheel (A-80656), Side Grip, Wheel Cover, Lock Nut Wrench



Continuous Rating Input Input Kuasa Berterusan 额定输入功率	1,050W
Wheel Diameter Diameter Roda 轮片直径	125mm (5")
No Load Speed (RPM) Kelajuan Tanpa Beban 回转数	12,000
Dimensions (L x W x H) Dimensi 体积	356x139x112mm (14"x5-1/2"x4-3/8")
Net Weight Berat Bersih 净重	2.6 - 3.8kg (5.8 - 8.4lbs)
Power Supply Cord Kabel Wayar 电源线	2.5m (8.2ft)

GA5040 125mm (5")

325

Angle Grinder Pengisar Sudut 角向磨光机

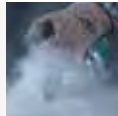

Slide Switch Suis Gelangsar 滑动开关



- **Connectable to Makita vacuum cleaner with optional dust collecting wheel guard**
Boleh bersambung dengan pembersih vakum Makita dengan alat pilihan pengumpul debu
可选附件轮状集尘护罩以连接 Makita 吸尘器

Standard Equipment: Depressed Center Wheel, Side Grip, Wheel Cover, Lock Nut Wrench



Continuous Rating Input Input Kuasa Berterusan 额定输入功率	1,100W
Wheel Diameter Diameter Roda 轮片直径	125mm (5")
No Load Speed (RPM) Kelajuan Tanpa Beban 回转数	11,000
Dimensions (L x W x H) Dimensi 体积	303x140x116mm (11-7/8"x5-1/2"x4-9/16")
Net Weight Berat Bersih 净重	2.4 - 3.5kg (5.2 - 7.8lbs)
Power Supply Cord Kabel Wayar 电源线	2.5m (8.2ft)

GA5080R 125mm (5")

318

Angle Grinder Pengisar Sudut 角向磨光机



Slide Switch Suis Gelangsar 滑动开关



- **X-LOCK for toolless accessory changes**
X-LOCK untuk perubahan aksesori tanpa alat
免工具更换配件的 X-LOCK

Standard Equipment: Depressed Center Wheel (E-00402), Side Grip, Wheel Cover



Continuous Rating Input Input Kuasa Berterusan 额定输入功率	1,400W
Wheel Diameter Diameter Roda 轮片直径	125mm (5")
Max Wheel Thickness Ketebalan Roda Maksimum 最大轮片厚度	6mm (1/4")
Max Cutting Depth Kedalaman Pemotongan Maksimum 最大切削深度	31mm (1-1/4")
No Load Speed (RPM) Kelajuan Tanpa Beban 回转数	12,000
Dimensions (L x W x H) Dimensi 体积	309x141x113mm (12-1/8"x5-9/16"x4-7/16")
Net Weight Berat Bersih 净重	2.5 - 3.6kg (5.5 - 7.9lbs.)
Power Supply Cord Kabel Wayar 电源线	2.5m (8.2ft)

GA5041C 125mm (5")

318

Angle Grinder Pengisar Sudut 角向磨光机



Slide Switch Suis Gelangsar 滑动开关



- **Super Joint System II developed for effective vibration absorption**
SJS generasi kedua berkesan untuk menyerap getaran
第二代 SJS 有效抑止震动

Standard Equipment: Depressed Center Wheel, Side Grip, Wheel Cover, Lock Nut Wrench



Continuous Rating Input Input Kuasa Berterusan 额定输入功率	1,400W
Wheel Diameter Diameter Roda 轮片直径	125mm (5")
No Load Speed (RPM) Kelajuan Tanpa Beban 回转数	2,800-11,000
Dimensions (L x W x H) Dimensi 体积	325x140x121mm (12-3/4"x5-1/2"x4-3/4")
Net Weight Berat Bersih 净重	2.7 - 3.8kg (5.9 - 8.4lbs)
Power Supply Cord Kabel Wayar 电源线	2.5m (8.2ft)

9565CR / PC 125mm (5")

318

Angle Grinder Pengisar Sudut 角向磨光机



Slide Switch Suis Gelangsar 滑动开关



- **SJS Mechanical Clutch System Helps Prevent Motor and Gear Damage**
Sistem SJS mencegah kerosakan pada motor dan gear
SJS 系统有助于防止马达和齿轮损坏

Standard Equipment:
9565CR: Depressed Center Wheel (B-56390), Side Grip, Wheel Cover, Lock Nut Wrench
9565PC: Side Grip, Wheel Cover, Lock Nut Wrench



Continuous Rating Input Input Kuasa Berterusan 额定输入功率	1,400W
Wheel Diameter Diameter Roda 轮片直径	125mm (5")
No Load Speed (RPM) Kelajuan Tanpa Beban 回转数	12,000
Dimensions (L x W x H) Dimensi 体积	299x139x103mm 9565CR (11-3/4"x5-1/2"x4-1/16") 307x139x103mm 9565PC (12-1/8"x5-1/2"x4")
Net Weight Berat Bersih 净重	2.4 - 3.5kg (5.2 - 7.7lbs)
Power Supply Cord Kabel Wayar 电源线	2.5m (8.2ft)



Recommended Accessories
Grinding Wheel for Heavy Industries

GRINDING | SANDING



GA6010 150mm (6")

303

Angle Grinder Pengisar Sudut 角向磨光机



Trigger Switch

Suis Pemicu 扳机开关



- **Powerful 1,050W motor**
Motor berkuasa 1,050W
强力1,050W马达

Standard Equipment: Depressed Center Wheel (A-80846), Side Grip, Wheel Cover, Lock Nut Wrench



Continuous Rating Input Input Kuasa Berterusan 额定输入功率	1,050W
Wheel Diameter Diameter Roda 轮片直径	150mm (6")
No Load Speed (RPM) Kelajuan Tanpa Beban 回转数	10,000
Dimensions (L x W x H) Dimensi 体积	356x169x112mm (14"x6-5/8"x4-3/8")
Net Weight Berat Bersih 净重	2.7 - 3.1kg (5.9 - 6.9lbs)
Power Supply Cord Kabel Wayar 电源线	2.5m (8.2ft)

GA6040 150mm (6")

325

Angle Grinder Pengisar Sudut 角向磨光机



Slide Switch

Suis Gelangsar 滑动开关



- **Super Joint System II developed for effective vibration absorption**
SJS generasi kedua berkesan untuk menyerap getaran
第二代 SJS 有效抑止震动

Standard Equipment: Depressed Center Wheel (A-80846), Side Grip, Wheel Cover, Lock Nut Wrench



Continuous Rating Input Input Kuasa Berterusan 额定输入功率	1,100W
Wheel Diameter Diameter Roda 轮片直径	150mm (6")
No Load Speed (RPM) Kelajuan Tanpa Beban 回转数	9,000
Dimensions (L x W x H) Dimensi 体积	303x171x116mm (11-7/8"x6-3/4"x4-9/16")
Net Weight Berat Bersih 净重	2.4 - 2.8kg (5.3 - 6.2lbs)
Power Supply Cord Kabel Wayar 电源线	2.5m (8.2ft)

GA6020C 150mm (6")

253

Angle Grinder Pengisar Sudut 角向磨光机



Trigger Switch

Suis Pemicu 扳机开关



- **Electric current limiter protects motor from overload**
Pembatasan arus elektrik melindungi motor dari kelebihan beban
电流限制器保护马达免超负荷

Standard Equipment: Depressed Center Wheel (A-80846), Side Grip, Wheel Cover, Lock Nut Wrench



Continuous Rating Input Input Kuasa Berterusan 额定输入功率	1,450W
Wheel Diameter Diameter Roda 轮片直径	150mm (6")
No Load Speed (RPM) Kelajuan Tanpa Beban 回转数	9,000
Dimensions (L x W x H) Dimensi 体积	390x169x120mm (15-3/8"x6-5/8"x4-3/4")
Net Weight Berat Bersih 净重	3.0 - 3.5kg (6.7 - 7.6lbs)
Power Supply Cord Kabel Wayar 电源线	2.5m (8.2ft)

Cordless
无绳电工具LED Flashlight
照明 LED
LED 照明Vacuum Cleaner
吸尘器
吸尘器Drilling / Fastening
钻孔 / 紧固
钻孔 / 紧固Impact Drilling / Demolition
冲击钻孔 / 拆除
冲击钻孔 / 拆除Cutting / Grinding
切割 / 磨削
切割 / 磨削Grinding / Sanding
磨削 / 打磨
磨削 / 打磨Sawing / Dicing
锯切 / 切割
锯切 / 切割Planing / Roasting
刨削 / 烘烤
刨削 / 烘烤Outdoor Power Equipment
户外动力设备
户外动力设备Makita
MAKITA

GRINDING | SANDING

GA7050 180mm (7")

204

Angle Grinder Pengisar Sudut 角向磨光机



Trigger Switch

Suis Pemicu 扳机开关

- **Most compact in its class**
Paling padat dalam kelasnya
在同类中最紧凑



Standard Equipment: Side Grip, Wheel Cover, Lock Nut Wrench



Continuous Rating Input Input Kuasa Berterusan 额定输入功率	2,000W
Wheel Diameter Diameter Roda 轮片直径	180mm (7")
No Load Speed (RPM) Kelajuan Tanpa Beban 回转数	8,500
Dimensions (L x W x H) Dimensi 体积	432x200x132mm (17"x7-7/8"x5-3/16")
Net Weight Berat Bersih 净重	3.98 - 5.00kg (8.8 - 11.0lbs)
Power Supply Cord Kabel Wayar 电源线	2.5m (8.2ft)

GA7063R 180mm (7")

218

Angle Grinder Pengisar Sudut 角向磨光机

Trigger Switch

Suis Pemicu 扳机开关

- **D-Handle protects operator's hand from materials**
Pemegang D melindungi tangan pengguna dari bahan
D型把手保护使用者的手远离物料



Standard Equipment: Side Grip, Wheel Cover, Lock Nut Wrench



Continuous rating input Panjang Strok 冲程长度	2,200W
Wheel Diameter Kelajuan Strok 冲程速度	180mm (7")
No Load Speed (RPM) Kapasiti 能力	8,500
Dimensions (L x W x H) Dimensi 体积	450x200x145mm (17-3/4"x7-7/8"x5-3/4")
Net weight Berat Bersih 净重	5.70 - 6.21kg (12.6 - 13.7lbs)
Power supply cord	2.5m (8.2ft)

GA7062 180mm (7")

218

Angle Grinder Pengisar Sudut 角向磨光机

Trigger Switch

Suis Pemicu 扳机开关

- **Developed for heavy duty applications such as foundry grinding**
Sesuai untuk aplikasi tugas berat
适合重型应用，如铸造磨削加工



Standard Equipment: Side Grip, Wheel Cover, Lock Nut Wrench



Continuous Rating Input Input Kuasa Berterusan 额定输入功率	2,200W
Wheel Diameter Diameter Roda 轮片直径	180mm (7")
No Load Speed (RPM) Kelajuan Tanpa Beban 回转数	8,500
Dimensions (L x W x H) Dimensi 体积	450x200x144mm (17-3/4"x7-7/8"x5-5/8")
Net Weight Berat Bersih 净重	5.51 - 6.02kg (12.2 - 13.3lbs)
Power Supply Cord Kabel Wayar 电源线	2.5m (8.2ft)

GA7061R 180mm (7")

218

Angle Grinder Pengisar Sudut 角向磨光机



Trigger Switch

Suis Pemicu 扳机开关

- **Developed for heavy duty applications such as foundry grinding**
Ringan untuk mengurangkan keletihan, meningkatkan produksi dengan berkesan
轻盈不易引起疲劳，有效的增加工作量



Standard Equipment: Side Grip, Wheel Cover, Lock Nut Wrench



Continuous Rating Input Input Kuasa Berterusan 额定输入功率	2,200W
Wheel Diameter Diameter Roda 轮片直径	180mm (7")
No Load Speed (RPM) Kelajuan Tanpa Beban 回转数	8,500
Dimensions (L x W x H) Dimensi 体积	450x200x145mm (17-3/4"x7-7/8"x5-3/4")
Net Weight Berat Bersih 净重	5.57 - 6.08kg (12.3 - 13.4lbs)
Power Supply Cord Kabel Wayar 电源线	2.5m (8.2ft)

GA7060R 180mm (7")

218

Angle Grinder Pengisar Sudut 角向磨光机



Trigger Switch

Suis Pemicu 扳机开关

- **Developed for heavy duty applications such as foundry grinding**
Sesuai untuk aplikasi tugas berat
适合重型应用，如铸造磨削加工



Standard Equipment: Side Grip, Wheel Cover, Lock Nut Wrench



Continuous Rating Input Input Kuasa Berterusan 额定输入功率	2,200W
Wheel Diameter Diameter Roda 轮片直径	180mm (7")
No Load Speed (RPM) Kelajuan Tanpa Beban 回转数	8,500
Dimensions (L x W x H) Dimensi 体积	450x200x144mm (17-3/4"x7-7/8"x5-5/8")
Net Weight Berat Bersih 净重	5.42 - 5.93kg (12 - 13.1lbs)
Power Supply Cord Kabel Wayar 电源线	2.5m (8.2ft)

GRINDING | SANDING

GA7060 180mm (7")

218

Angle Grinder Pengisar Sudut 角向磨光机



Trigger Switch Suis Pemicu 扳机开关



- **Motor more durable for heavy duty applications**
Motor lebih tahan lama untuk aplikasi tugas berat
马达更耐用

Standard Equipment: Side Grip, Wheel Cover, Lock Nut Wrench



Continuous Rating Input Input Kuasa Berterusan 额定输入功率	2,200W
Wheel Diameter Diameter Roda 轮片直径	180mm (7")
No Load Speed (RPM) Kelajuan Tanpa Beban 回转数	8,500
Dimensions (L x W x H) Dimensi 体积	450x200x144mm (17-3/4"x7-7/8"x5-5/8")
Net Weight Berat Bersih 净重	5.38 - 5.89kg (11.9 - 13lbs)
Power Supply Cord Kabel Wayar 电源线	2.5m (8.2ft)

GA7020 180mm (7")

204

Angle Grinder Pengisar Sudut 角向磨光机



Trigger Switch Suis Pemicu 扳机开关



- **Powerful 2,200W Motor for Faster Material Removal**
Motor berkuasa 2,200W untuk pengisaran yang lebih cepat
功率强大的 2,200W 马达提供更快的研磨

Standard Equipment: Side Grip, Wheel Cover, Lock Nut Wrench



Continuous Rating Input Input Kuasa Berterusan 额定输入功率	2,200W
Wheel Diameter Diameter Roda 轮片直径	180mm (7")
No Load Speed (RPM) Kelajuan Tanpa Beban 回转数	8,500
Dimensions (L x W x H) Dimensi 体积	473x200x140mm (18-5/8"x7-7/8"x5-1/2")
Net Weight Berat Bersih 净重	5.56 - 6.06kg (12.26 - 13.36lbs)
Power Supply Cord Kabel Wayar 电源线	2.5m (8.2ft)

GA7040R 180mm (7")

204

Angle Grinder Pengisar Sudut 角向磨光机



Trigger Switch Suis Pemicu 扳机开关



- **Superior heavy duty motor with outstanding durability**
Motor tugas berat unggul dengan ketahanan yang luar biasa
耐用性卓越的马达

Standard Equipment: Side Grip, Wheel Cover, Lock Nut Wrench



Continuous Rating Input Input Kuasa Berterusan 额定输入功率	2,600W
Wheel Diameter Diameter Roda 轮片直径	180mm (7")
No Load Speed (RPM) Kelajuan Tanpa Beban 回转数	8,500
Dimensions (L x W x H) Dimensi 体积	503x200x140mm (19-3/4"x7-7/8"x5-1/2")
Net Weight Berat Bersih 净重	6.48 - 6.98kg (14.3 - 15.4lbs)
Power Supply Cord Kabel Wayar 电源线	2.5m (8.2ft)



GA9050 230mm (9")

204

Angle Grinder Pengisar Sudut 角向磨光机

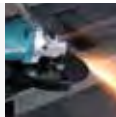

Trigger Switch Suis Pemicu 扳机开关



- **Compact gear housing increases maximum cutting depth by 4mm**
Kotak gear padat untuk meningkatkan kedalaman pemotongan maksimum kepada 4mm
紧凑的齿轮箱增加最大切割深度至4mm

Standard Equipment: Side Grip, Wheel Cover, Lock Nut Wrench



Continuous Rating Input Input Kuasa Berterusan 额定输入功率	2,000W
Wheel Diameter Diameter Roda 轮片直径	230mm (9")
No Load Speed (RPM) Kelajuan Tanpa Beban 回转数	6,600
Dimensions (L x W x H) Dimensi 体积	432x250x132mm (17"x9-7/8"x5-3/16")
Net Weight Berat Bersih 净重	4.64 - 6.94kg (10.2 - 15.3lbs)
Power Supply Cord Kabel Wayar 电源线	2.5m (8.2ft)

Cordless
Tali Wayar BebasLED Flashlight
Lampu Sulu LED
LED BERTAMBAHVacuum Cleaner
Penyedut Debu
VACUUMDrilling / Fastening
Cairan / Pasukan
MIL / 螺絲Impact Drilling / Demolition
Cairan / Pasukan
GAMPAK / 破壞Cutting / Grinding
Pemotongan / Pengkilan
GAMPAKGrinding / Sanding
Pengkilan / Pengkilan
GAMPAKSawing
Gergaji
GAMPAKPolishing / Rustproofing
Polish / Pasukan
GAMPAKOthers
Lain-lain
GAMPAKOutdoor Power Equipment
Alatan Perti Luar
GAMPAKMakita
TAMBAH

GRINDING | SANDING

GA9061R 230mm (9")

218

Angle Grinder Pengisar Sudut 角向磨光机



Trigger Switch

Suis Pemicu 扳机开关

- **Motor more durable for heavy duty applications**
Motor lebih tahan lama untuk aplikasi tugas berat
马达更耐用



Standard Equipment: Side Grip, Wheel Cover, Lock Nut Wrench



Continuous Rating Input Input Kuasa Berterusan 额定输入功率	2,200W
Wheel Diameter Diameter Roda 轮片直径	230mm (9")
No Load Speed (RPM) Kelajuan Tanpa Beban 回转数	6,600
Dimensions (L x W x H) Dimensi 体积	450x250x145mm (17-3/4"x9-7/8"x5-3/4")
Net Weight Berat Bersih 净重	5.68 - 8.04kg (12.5 - 17.7lbs)
Power Supply Cord Kabel Wayar 电源线	2.5m (8.2ft)

GA9060R 230mm (9")

218

Angle Grinder Pengisar Sudut 角向磨光机



Trigger Switch

Suis Pemicu 扳机开关

- **Powerful 2,200W motor**
Motor berkuasa 2,200W
强力2,200W马达



Standard Equipment: Side Grip, Wheel Cover, Lock Nut Wrench



Continuous Rating Input Input Kuasa Berterusan 额定输入功率	2,200W
Wheel Diameter Diameter Roda 轮片直径	230mm (9")
No Load Speed (RPM) Kelajuan Tanpa Beban 回转数	6,600
Dimensions (L x W x H) Dimensi 体积	450x250x144mm (17-3/4"x9-7/8"x5-5/8")
Net Weight Berat Bersih 净重	5.52 - 7.88kg (12.8 - 17.4lbs)
Power Supply Cord Kabel Wayar 电源线	2.5m (8.2ft)

GA9060 230mm (9")

218

Angle Grinder Pengisar Sudut 角向磨光机



Trigger Switch

Suis Pemicu 扳机开关

- **Motor more durable for heavy duty applications**
Motor lebih tahan lama untuk aplikasi tugas berat
马达更耐用



Standard Equipment: Side Grip, Wheel Cover, Lock Nut Wrench



Continuous Rating Input Input Kuasa Berterusan 额定输入功率	2,200W
Wheel Diameter Diameter Roda 轮片直径	230mm (9")
No Load Speed (RPM) Kelajuan Tanpa Beban 回转数	6,600
Dimensions (L x W x H) Dimensi 体积	450x250x144mm (17-3/4"x9-7/8"x5-5/8")
Net Weight Berat Bersih 净重	5.50 - 7.86kg (12.1 - 17.3lbs)
Power Supply Cord Kabel Wayar 电源线	2.5m (8.2ft)

GA9020 230mm (9")

204

Angle Grinder Pengisar Sudut 角向磨光机

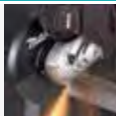

Trigger Switch

Suis Pemicu 扳机开关

- **Spiral bevel gears more efficient transfer of energy**
Gear serong lingkaran untuk pemindahan tenaga yang lebih cekap
螺旋锥齿轮高效输送能源



Standard Equipment: Side Grip, Wheel Cover, Lock Nut Wrench



Continuous Rating Input Input Kuasa Berterusan 额定输入功率	2,200W
Wheel Diameter Diameter Roda 轮片直径	230mm (9")
No Load Speed (RPM) Kelajuan Tanpa Beban 回转数	6,000
Dimensions (L x W x H) Dimensi 体积	473x249x140mm (18-5/8"x9-3/4"x5-1/2")
Net Weight Berat Bersih 净重	5.76 - 8.05kg (12.7 - 17.8lbs)
Power Supply Cord Kabel Wayar 电源线	2.5m (8.2ft)

SA5040C 125mm (5")

318

Angle Sander Pengampelas Sudut 角向抛光机

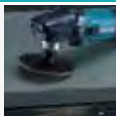

Trigger Switch

Suis Pemicu 扳机开关

- **Electronic current limiter prevents motor burnout due to overloading**
Pengehad arus elektronik mencegah motor dari terbakar yang disebabkan oleh beban lampau
电子电流限制器可防止超负荷引起的马达烧毁



Standard Equipment: Pad, Side Grip, Head Cover



Continuous Rating Input Input Kuasa Berterusan 额定输入功率	1,400W
Wheel Diameter Diameter Roda 轮片直径	125mm (5")
Capacity Kapasiti 能力	Pad : 115mm (4-1/2")
No Load Speed (RPM) Kelajuan Tanpa Beban 回转数	2,000-7,800
Dimensions (L x W x H) Dimensi 体积	315x115x121mm (12-3/8"x4-1/2"x4-3/4")
Net Weight Berat Bersih 净重	2.5 - 3.7kg (5.5 - 8.2lbs)
Power Supply Cord Kabel Wayar 电源线	2.5m (8.2ft)

GRINDING | SANDING

PK5001C 125mm (5")

318

Angle Sander Pengampelas Sudut 角向抛光机



- **Ideal one for effective stone polishing**
Untuk penggilap batu yang berkesan
有效的石材抛光

Standard Equipment: Side Grip, Lock Nut Wrench



Continuous Rating Input Input Kuasa Berterusan 额定输入功率	1,400W
Wheel Diameter Diameter Roda 轮片直径	125mm (5")
Capacity Kapasiti 能力	Pad : 115mm (4-1/2")
No Load Speed (RPM) Kelajuan Tanpa Beban 回转数	2,000-6,800
Dimensions (L x W x H) Dimensi 体积	328x80x126mm (12-7/8"x3-1/8"x5")
Net Weight Berat Bersih 净重	2.4 - 2.9kg (5.3 - 6.4lbs)
Power Supply Cord Kabel Wayar 电源线	4.0m (13.1ft)

GV5010 125mm (5")

64

Disc Sander Pelicin Piring 盘式砂光机



- **For faster and easier removal of paint/ rust**
Untuk penyingkiran cat / karat yang lebih cepat dan mudah
更快, 更容易去除油漆/锈迹

Standard Equipment: Abrasive Disc, Plastic Pad, Side Grip, Hex socket head bolt, Washer, Hex Wrench



Continuous Rating Input Input Kuasa Berterusan 额定输入功率	440W
Abrasive Disc Size Saiz Cakera 磨盘尺寸	125mm (5")
Capacity Kapasiti 能力	Pad: 120mm (4-3/4")
No Load Speed (RPM) Kelajuan Tanpa Beban 回转数	4,500
Dimensions (L x W x H) Dimensi 体积	200x74x181mm (7-7/8"x2-15/16"x7-1/8")
Net Weight Berat Bersih 净重	1.2kg (2.6lbs)
Power Supply Cord Kabel Wayar 电源线	2.5m (8.2ft)

GV6010 150mm (6")

64

Disc Sander Pelicin Piring 盘式砂光机



- **Powerful 440W motor for fast material removal**
Motor berkuasa 440W untuk penyingkiran bahan cepat
功率强劲的440W马达

Standard Equipment: Abrasive Disc, Plastic Pad, Side Grip, Hex socket head bolt, Washer, Hex Wrench



Continuous Rating Input Input Kuasa Berterusan 额定输入功率	440W
Abrasive Disc Size Saiz Cakera 磨盘尺寸	150mm (6")
Capacity Kapasiti 能力	Pad: 120mm (4-3/4")
No Load Speed (RPM) Kelajuan Tanpa Beban 回转数	4,500
Dimensions (L x W x H) Dimensi 体积	200x74x181mm (7-7/8"x2-15/16"x7-1/8")
Net Weight Berat Bersih 净重	1.2kg (2.6lbs)
Power Supply Cord Kabel Wayar 电源线	2.5m (8.2ft)

GV7000C 180mm (7")

303

Disc Sander Pelicin Piring 盘式砂光机



- **Motor-over-pad design for better balance and control**
Reka bentuk motor-over-pad untuk keseimbangan dan kawalan yang lebih baik
更好的平衡易于控制

Standard Equipment: Abrasive Disc, Rubber Pad, Lock Nut Wrench, Wrench, Side Grip

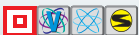

Continuous Rating Input Input Kuasa Berterusan 额定输入功率	900W
Abrasive Disc Size Saiz Cakera 磨盘尺寸	180mm (7")
Capacity Kapasiti 能力	Pad: 180mm (7")
No Load Speed (RPM) Kelajuan Tanpa Beban 回转数	2,500-4,700
Overall Length Panjang Keseluruhan 总长度	210mm (8-1/4")
Net Weight Berat Bersih 净重	2.1kg (4.6lbs)
Power Supply Cord Kabel Wayar 电源线	2.5m (8.2ft)

9215SB 150mm (6")

100

Disc Sander Pelicin Piring 盘式砂光机



- **Powerful motor in well-balanced body for fast and steady sanding**
Motor berkuasa dengan badan yang seimbang
强劲的马达平衡良好机身

Standard Equipment: Rubber Pad, Lock Nut Wrench, Wrench, Side Grip



Continuous Rating Input Input Kuasa Berterusan 额定输入功率	570W
Wire Cup Brush Berus Wayar Cawan 杯型钢丝刷	110mm (4-3/8")
Abrasive Disc Size Saiz Cakera 磨盘尺寸	150mm (6")
No Load Speed (RPM) Kelajuan Tanpa Beban 回转数	4,500
Overall Length Panjang Keseluruhan 总长度	225mm (8-7/8")
Net Weight Berat Bersih 净重	2.9kg (6.3lbs)
Power Supply Cord Kabel Wayar 电源线	2.5m (8.2ft)

Cordless
Tidakkabel 无线LED Flashlight
Lampu Sulu LED
LED 手电筒Vacuum Cleaner
Penyedut Debu
吸尘器Drilling / Fastening
Cairan / Pasukan
电钻 / 螺絲Impact Drilling / Demolition
Cairan / Pasukan
电钻 / 拆屋Cutting / Finishing
Pemotong
切割Grinding / Sanding
Penggilap / Poles
磨光 / 抛光Sawing
Dagang
锯切Planing / Roasting
Penyalutan / Pengkilap
刨光 / 抛光Others
Lain-lain
其他Outdoor Power Equipment
Alatan Peralatan Luar
户外动力设备Thakita
TINTA

GRINDING | SANDING

9237C 180mm (7")

303

Polisher Penggilap 打蜡机



- **Fast and powerful for clear coat finishes**
Cepat dan berkuasa untuk kemasinan kot yang jelas
快速清除涂层

Standard Equipment: Side Handle, Hex Wrench, Wool Pad



Continuous Rating Input Input Kuasa Berterusan 额定输入功率	1,200W
Capacity Kapasiti 能力	Wool Pad: 180mm (7") Wool Bonnet: 180mm (7")
No Load Speed (RPM) Kelajuan Tanpa Beban 回转数	0 - 3,200
Dimensions (L x W x H) Dimensi 体积	431x198x187mm (17"x7-3/4"x7-3/8")
Net Weight Berat Bersih 净重	3.2 - 3.4kg (7.0 - 7.5lbs)
Power Supply Cord Kabel Wayar 电源线	2.5m (8.2ft)

PO5000C 125mm (5")

318

Random Orbit Polisher Pelicin Orbit 砂光机



- **Wide variety of optional accessories (Pad, Sponge pad, Felt pad, Wool pad)**
Pelbagai aksesori pilihan (pad, pad sponge, pad felt, pad bulu)
各种可选配件 (垫, 海绵垫, 毡垫, 羊毛垫)

Standard Equipment: Hex Wrench



PO5000C/PO6000C
Models and specs may vary by country

Continuous Rating Input Input Kuasa Berterusan 额定输入功率	900W
Pad Size Saiz Pad 垫子尺寸	125mm (5")
Orbits Per Minute (OPM) Bilangan Putaran 轨道转速	0 - 6,800
Strokes Per Minute (SPM) Kelajuan Strok 冲程速度	0 - 13,600
No Load Speed (RPM) Kelajuan Tanpa Beban 回转数	0 - 780
Orbit Diameter Kelajuan Tanpa Beban 回转数	5.5 mm (7/32")
Dimensions (L x W x H) Dimensi 体积	451x123x134mm (17-3/4"x4-7/8"x5-1/4")
Net Weight Berat Bersih 净重	2.8 - 3.0kg (6.2 - 6.5lbs)
Power Supply Cord Kabel Wayar 电源线	4.0m (13.1ft)

PO6000C 150mm (6")

318

Random Orbit Polisher Pelicin Orbit 砂光机



- **Wide variety of optional accessories (Pad, Sponge pad, Felt pad, Wool pad)**
Pelbagai aksesori pilihan (pad, pad sponge, pad felt, pad bulu)
各种可选配件 (垫, 海绵垫, 毡垫, 羊毛垫)

Standard Equipment: Hex Wrench



PO5000C/PO6000C
Models and specs may vary by country

Continuous Rating Input Input Kuasa Berterusan 额定输入功率	900W
Pad Size Saiz Pad 垫子尺寸	150mm (6")
Orbits Per Minute (OPM) Bilangan Putaran 轨道转速	0 - 6,800
Strokes Per Minute (SPM) Kelajuan Strok 冲程速度	0 - 13,600
No Load Speed (RPM) Kelajuan Tanpa Beban 回转数	0 - 780
Orbit Diameter Kelajuan Tanpa Beban 回转数	5.5mm (7/32")
Dimensions (L x W x H) Dimensi 体积	451x148x126mm (17-3/4"x5-7/8"x5")
Net Weight Berat Bersih 净重	2.8 - 3.0kg (6.2 - 6.5lbs)
Power Supply Cord Kabel Wayar 电源线	4.0m (13.1ft)

PV7000C 180mm (7")

303

Polisher Penggilap 抛光机



- **Lightweight for reduced operator fatigue**
Ringan untuk mengurangkan keletihan pengguna
轻量不易引起疲劳

Standard Equipment: Side Handle, Pad, Wrench



Continuous Rating Input Input Kuasa Berterusan 额定输入功率	900W
Capacity Kapasiti 能力	Pad: 180mm (7") Wool Bonnet: 180mm (7")
No Load Speed (RPM) Kelajuan Tanpa Beban 回转数	600 - 2,100
Overall Length Panjang Keseluruhan 总长度	210mm (8-1/4")
Net Weight Berat Bersih 净重	2.1kg (4.6lbs)
Power Supply Cord Kabel Wayar 电源线	2.5m (8.2ft)

GD0600 6mm (1/4")

325

Die Grinder Gerinda Lurus 电磨



- **Large Flush-Mount Paddle Switch for Comfortable Operation**
Suis Flush-mount mudah digunakan
大型平装式按钮开关易于操作

Standard Equipment: Wrench x2



Continuous Rating Input Input Kuasa Berterusan 额定输入功率	400W
Capacity Kapasiti 能力	Collet: 3.6mm or 1/8", 1/4"
Wheel Diameter Diameter Roda 轮片直径	38mm (1-1/2")
No Load Speed (RPM) Kelajuan Tanpa Beban 回转数	25,000
Dimensions (L x W x H) Dimensi 体积	358x82x82mm (14-1/8"x3-1/4"x3-1/4")
Net Weight Berat Bersih 净重	1.71 - 1.87kg (3.77 - 4.12lbs)
Power Supply Cord Kabel Wayar 电源线	2.5m (8.2ft)

GRINDING | SANDING

GD0601 6mm (1/4")

325

Die Grinder

Gerinda Lurus
电磨

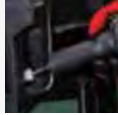

- **Powerful 400W motor**
Motor berkuasa 400W
强力400W马达



Standard Equipment: [Wrench x2](#)



GD0603 6mm (1/4")

64

Die Grinder

Gerinda Lurus
电磨



- **Compact and easy handling**
Padat dan mudah digunakan
紧凑且易于使用



Standard Equipment: [Spanner](#), [Wheel points](#)



GD0800C 8mm (1/4")

318

Die Grinder

Gerinda Lurus
电磨



- **Electronic Controller for Operator Convenience**
Pengawal elektronik untuk kemudahan pengguna
电子控制器方便使用者



Standard Equipment: [Wrench x2](#)

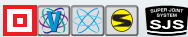

GD0801C 8mm (1/4")

318

Die Grinder

Gerinda Lurus
电磨

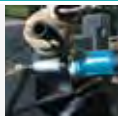

- **Powerful 750W motor for faster material removal**
Motor berkuasa 750W untuk pengisaran yang lebih cepat
功率强大的750W马达提供更快的研磨



Standard Equipment: [Side Handle](#), [Wrench x2](#)

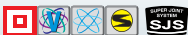

GD0811C 8mm (1/4")

318

Die Grinder

Gerinda Lurus
电磨



- **Ideal for grinding internal surfaces, removing paint etc. using with flap wheel**
Sesuai untuk mengisar permukaan dalaman, cat dan lain-lain
适用于研磨内表面, 使用皮瓣轮去除油漆等



Standard Equipment: [Side Handle](#), [Wrench x2](#)

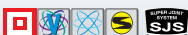

Continuous Rating Input Input Kuasa Berterusan 额定输入功率	400W
Capacity Kapasiti 能力	Collet: 3,6mm or 1/8", 1/4"
Wheel Diameter Diameter Roda 轮片直径	38mm (1-1/2")
No Load Speed (RPM) Kelajuan Tanpa Beban 回转数	25,000
Dimensions (L x W x H) Dimensi 体积	359x82x82mm (14-1/8"x3-1/4"x3-1/4")
Net Weight Berat Bersih 净重	1.68 - 1.84kg (3.70 - 4.06lbs)
Power Supply Cord Kabel Wayar 电源线	2.5m (8.2ft)

Continuous Rating Input Input Kuasa Berterusan 额定输入功率	240W
Capacity Kapasiti 能力	Collet: 6mm or 1/4"
Max Wheel Diameter Diameter Roda 轮片直径	19mm (3/4")
No Load Speed (RPM) Kelajuan Tanpa Beban 回转数	28,000
Diameter of Grip Diameter Silinder 握筒直径	65mm
Dimensions (L x W x H) Dimensi 体积	289x64x67mm (11-3/8"x2-1/2"x2-5/8")
Net Weight Berat Bersih 净重	0.98kg (2.16lbs)
Power Supply Cord Kabel Wayar 电源线	2.5m (8.2ft)

Continuous Rating Input Input Kuasa Berterusan 额定输入功率	750W
Capacity Kapasiti 能力	Collet: 3,6,8mm or 1/8", 1/4"
Wheel Diameter Diameter Roda 轮片直径	25mm (1")
No Load Speed (RPM) Kelajuan Tanpa Beban 回转数	7,000-28,000
Dimensions (L x W x H) Dimensi 体积	371x75x75mm (14-5/8"x2-15/16"x2-15/16")
Net Weight Berat Bersih 净重	1.88kg (4.14lbs)
Power Supply Cord Kabel Wayar 电源线	2.5m (8.2ft)

Continuous Rating Input Input Kuasa Berterusan 额定输入功率	750W
Capacity Kapasiti 能力	Collet: 8mm (1/4")
Max Wheel Diameter Diameter Roda 轮片直径	25mm (1")
No Load Speed (RPM) Kelajuan Tanpa Beban 回转数	7,000-29,000
Dimensions (L x W x H) Dimensi 体积	390x75x88mm (15-3/8"x2-15/16"x3-1/2")
Net Weight Berat Bersih 净重	1.96 - 1.97kg (4.32 - 4.34lbs)
Power Supply Cord Kabel Wayar 电源线	2.5m (8.2ft)

Continuous Rating Input Input Kuasa Berterusan 额定输入功率	750W
Capacity Kapasiti 能力	Collet: 8mm (1/4")
Max Wheel Diameter Diameter Roda 轮片直径	50mm (2")
No Load Speed (RPM) Kelajuan Tanpa Beban 回转数	1,800-7,000
Dimensions (L x W x H) Dimensi 体积	390x75x88mm (15-3/8"x2-15/16"x3-1/2")
Net Weight Berat Bersih 净重	1.99 - 2.00kg (4.39 - 4.41lbs)
Power Supply Cord Kabel Wayar 电源线	2.5m (8.2ft)

Cordless
Tali Wayar Bebas

LED Flashlight
Lampu Sinar LED
LED BRIGHT

Vacuum Cleaner
Penyedut Debu
VACUUM

Drilling / Fastening
Cairan / Pasukan
MIL / 螺絲

Impact Drilling / Demolition
Cairan / Pasukan
GAMPAK / 破壞

Cutting / Finishing
Pemotongan
GAMPAK

Grinding / Sanding
Pengisar / Pasukan
GAMPAK

Sawing / Daging
Daging
GAMPAK

Planing / Roosting
Pengisaran / Pasukan
GAMPAK

Others
Lain-lain
GAMPAK

Outdoor Power Equipment
Alatan Kuasa Luar
GAMPAK

Others
Lain-lain
GAMPAK

Thakita

GRINDING | SANDING

GS5000 125mm (5")

204 W

Straight Grinder

Pengisar Lurus
直向砂轮机



- **Powerful 750W motor**
Motor berkuasa 750W
强力750W马达



Standard Equipment: Hex Wrench, Wrench



Continuous Rating Input Input Kuasa Berterusan 额定输入功率	750W
Wheel Diameter Diameter Roda 轮片直径	125mm (5")
Hole Diameter Diameter Lubang 孔直径	12.7, 20mm (1/2, 13/16")
No Load Speed (RPM) Kelajuan Tanpa Beban 回转数	5,600
Dimensions (L x W x H) Dimensi 体积	590x189x116mm (23-1/4"x8-7/16"x4-9/16")
Net Weight Berat Bersih 净重	5.0 - 5.2kg (11.0 - 11.5lbs)
Power Supply Cord Kabel Wayar 电源线	2.5m (8.2ft)

GS6000 150mm (6")

204 W

Straight Grinder

Pengisar Lurus
直向砂轮机



- **Powerful 750W motor**
Motor berkuasa 750W
强力750W马达



Standard Equipment: Hex Wrench, Wrench



Continuous Rating Input Input Kuasa Berterusan 额定输入功率	750W
Wheel Diameter Diameter Roda 轮片直径	150mm (6")
Hole Dia. Diameter Lubang 孔直径	12.7, 20mm (1/2, 13/16")
No Load Speed (RPM) Kelajuan Tanpa Beban 回转数	5,600
Dimensions (L x W x H) Dimensi 体积	590x216x130mm (23-1/4"x8-1/2"x5-1/8")
Net Weight Berat Bersih 净重	5.2 - 5.4kg (11.4 - 12.0lbs)
Power Supply Cord Kabel Wayar 电源线	2.5m (8.2ft)

TM3000C

459 W

Multi Tool

Mesin Pemotong Berbilang Fungsi
多功能切割打磨机



- **Powerful 320W motor with improved performance**
Motor berkuasa 320W dengan prestasi yang lebih baik
强力320W马达，改进的性能



Standard Equipment: Hex Wrench



Continuous Rating Input Input Kuasa Berterusan 额定输入功率	320W
Strokes Per Minute (SPM) Kelajuan Strok 冲程速度	6,000-20,000
Dimensions (L x W x H) Dimensi 体积	275x64x92mm (10-7/8"x2-1/2"x3-5/8")
Net Weight Berat Bersih 净重	1.4 - 1.5kg (3.2 - 3.3lbs)
Power Supply Cord Kabel Wayar 电源线	5.0m (16.4ft)



TM3000C/TM40D/TM50D

Models and specs may vary by country

TM3010CX6

459 W

Multi Tool

Mesin Pemotong Berbilang Fungsi
多功能切割打磨机



- **Toolless clamp system for fast accessory installation**
Sistem pemasangan aksesori tanpa alat
免工具快速安装与更换配件



Standard Equipment: Multi Tool Plunge Cut Saw Blade 32, Segment Saw Blade 85, Sanding Pad

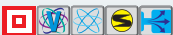

Continuous Rating Input Input Kuasa Berterusan 额定输入功率	320W
Strokes Per Minute (SPM) Kelajuan Strok 冲程速度	6,000-20,000
Dimensions (L x W x H) Dimensi 体积	283x68x87mm (11-1/8"x2-11/16"x3-7/16")
Net Weight Berat Bersih 净重	1.6 - 1.7kg (3.7 - 3.9lbs)
Power Supply Cord Kabel Wayar 电源线	2.5m (8.2ft)



TM3010C

Models and specs may vary by country

GB602 150mm (6")

Bench Grinder

Pengisar
台式砂轮机



- **Wheel covers have built-in task lights**
Lampu tugas terbina dalam pelindung roda
轮罩具有内置任务灯



Standard Equipment: Safety Eye Shield, Protection glasses, Wrench x2



Continuous Rating Input Input Kuasa Berterusan 额定输入功率	250W
Wheel Diameter Diameter Roda 轮片直径	150mm (6")
Wheel Width Lebar Roda 轮片宽度	16mm (5/8")
Hole Dia. Diameter Lubang 孔直径	12.7mm (1/2")
H.P.	1/3
No Load Speed (RPM) Kelajuan Tanpa Beban 回转数	2,850 (50Hz)/ 3,450 (60Hz)
Dimensions (L x W x H) Dimensi 体积	375x205x286mm (14-49/64"x8"x11-17/64")
Net Weight Berat Bersih 净重	9.31 - 9.08kg (20.02 - 20.52lbs)

GRINDING | SANDING

GB801 205mm (8")

Bench Grinder

Pengisar
台式砂轮机



- Adjustable wheel balance feature reduces vibration
Pelarasanimbangan roda mengurangi getaran
平衡调整减少振动

Standard Equipment: Safety Eye Shield, Protection glasses, Wrench x2



Continuous Rating Input Input Kuasa Berterusan 额定输入功率	550W
Wheel Diameter Diameter Roda 轮片直径	205mm (8")
Wheel Width Lebar Roda 轮片宽度	19mm (3/4")
Hole Dia. Diameter Lubang 孔直径	15.88mm (5/8")
H.P.	3/4
No Load Speed (RPM) Kelajuan Tanpa Beban 回转数	2,850 (50Hz)/ 3,450 (60Hz)
Dimensions (L x W x H) Dimensi 体积	395x265x333mm (15-9/16"x10-7/16"x13-7/64")
Net Weight Berat Bersih 净重	19.91 - 19.63kg (43.89 - 43.28lbs)

PC5010C 125mm (5")

318

Concrete Planer

Pengampelas
砂光机



- Compact and Lightweight for High Production Work
Kompak dan ringan untuk kerja pengeluaran yang tinggi
紧凑轻巧型，更有效率地工作

Standard Equipment: Lock Nut Wrench



Continuous Rating Input Input Kuasa Berterusan 额定输入功率	1,400W
Wheel Diameter Diameter Roda 轮片直径	125mm (5")
Hole Diameter Diameter Lubang 孔直径	22.23mm (7/8")
No Load Speed (RPM) Kelajuan Tanpa Beban 回转数	4,000 - 9,000
Dimensions (L x W x H) Dimensi 体积	350x231x179mm (13-3/4"x9-1/8"x7")
Net Weight Berat Bersih 净重	2.5 - 3.6kg (5.5 - 7.9lbs.)
Power Supply Cord Kabel Wayar 电源线	4.0m (13.1ft)

PC5000C 125mm (5")

253

Concrete Planer

Pengampelas
砂光机



- Electronic current limiter helps protect the motor from overload
Pengehad arus elektronik melindungi motor daripada beban lampau
电子电流限制器有助于防止马达超负荷

Standard Equipment: Lock Nut Wrench, Hex Wrench, Dust Bag Assembly



Continuous Rating Input Input Kuasa Berterusan 额定输入功率	1,400W
Wheel Diameter Diameter Roda 轮片直径	125mm (5")
Hole Dia. Diameter Lubang 孔直径	22.23mm (7/8")
No Load Speed (RPM) Kelajuan Tanpa Beban 回转数	10,000
Dimensions (L x W x H) Dimensi 体积	437x235x195mm (17-1/8"x9-1/4"x7-5/8")
Net Weight Berat Bersih 净重	4kg (8.9lbs)
Power Supply Cord Kabel Wayar 电源线	5.0m (16.4ft)

PC5001C 125mm (5")

253

Concrete Planer

Pengampelas
砂光机



- Soft start suppresses start-up reaction for more precision and longer tool life
Penghidupan secara perlahan untuk ketepatan yang lebih baik dan memanjangkan hayat alat
缓速启动提高准确性和延长工具使用寿命

Standard Equipment: Lock Nut Wrench, Hex Wrench, Dust Bag Assembly



Continuous Rating Input Input Kuasa Berterusan 额定输入功率	1,400W
Wheel Diameter Diameter Roda 轮片直径	125mm (5")
No Load Speed (RPM) Kelajuan Tanpa Beban 回转数	10,000
Dimensions (L x W x H) Dimensi 体积	479x182x195mm (18-13/16"x7-1/8"x7-5/8")
Net Weight Berat Bersih 净重	4kg (8.9lbs)
Power Supply Cord Kabel Wayar 电源线	5m (16.4ft)

PW5001C 125mm (5")

318

Stone Polisher

Penggilap Batu
水磨石机



- Variable speed control dial enables user to match the speed to the application
Pilihan kawalan kelajuan berubah untuk pelbagai aplikasi
变速控制选择适合多种应用

Standard Equipment: Rubber Pad, Side Grip, Wrench, Head Cover

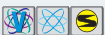

Continuous Rating Input Input Kuasa Berterusan 额定输入功率	900W
Capacity Kapasiti 能力	Pad: 100-125mm (4-5")
No Load Speed (RPM) Kelajuan Tanpa Beban 回转数	2,000-4,000
Overall Length Panjang Keseluruhan 总长度	359mm (14-1/8")
Net Weight Berat Bersih 净重	2.3 - 2.6kg (5.1 - 5.7lbs)
Power Supply Cord Kabel Wayar 电源线	4.0m (13.1ft)

Cordless
Terdapat dalamLED Flashlight
Lampu Saku LED
- LED BRIGHTVacuum Cleaner
Penyedut Debu
- 2.5LDrilling / Fastening
Gali / Pasang
- 1/2" / 3/8"Impact Drilling / Demolition
Gali / Pasang
- 1/2" / 3/8"Cutting / Finishing
Potong
- 1/2"Grinding / Sanding
Pengampelas / Pasang
- 1/2"Sawing
Gali
- 1/2"Planing / Roasting
Penggilap / Pasang
- 1/2"Others
Lain-lain
- 1/2"Outdoor Power Equipment
Alatan Peralatan Luar
- 1/2"Makita
- 1/2"

GRINDING | SANDING

9404 100mm x 610mm (4" x 24")

303 

Belt Sander Pengampelas 带式砂光机



- **Powerful 1,010W motor for fast material removal**
Motor berkuasa 1,010W untuk pengisaran yang lebih cepat
功率强大的 1,010W 马达提供更快的研磨



Standard Equipment: Abrasive Belt, Dust bag assembly



Continuous Rating Input Input Kuasa Berterusan 额定输入功率	1,010W
Belt Size Saiz Tali Pinggang 皮带尺寸	100 x 610mm (4" x 24")
Belt Speed Kelajuan Tali Pinggang 皮带速度	210-440m/min (690-1,440ft/min)
Overall Length Panjang Keseluruhan 总长度	334mm (13-1/8")
Net Weight Berat Bersih 净重	4.8kg (10.6lbs)
Power Supply Cord Kabel Wayar 电源线	5.0m (16.4ft)

9903 76mm x 533mm (3" x 21")

303 

Belt Sander Pengampelas 带式砂光机



- **Sands wood or metal and removes paint and rust**
Melicinkan kayu atau logam, menghilangkan cat dan karat
打磨木头或金属，去除油漆和铁锈



Standard Equipment: Abrasive Belt, Dust bag assembly



Continuous Rating Input Input Kuasa Berterusan 额定输入功率	1,010W
Belt Size Saiz Tali Pinggang 皮带尺寸	76 x 533mm (3" x 21")
Belt Speed Kelajuan Tali Pinggang 皮带速度	210 - 440m/min (690 - 1,440 ft/min)
Overall Length Panjang Keseluruhan 总长度	296mm (11-5/8")
Net Weight Berat Bersih 净重	4.3kg (9.5lbs)
Power Supply Cord Kabel Wayar 电源线	5.0m (16.4ft)

9401 100mm x 610mm (4" x 24")

153 

Belt Sander Pengampelas 带式砂光机



- **Highly-efficient dust collection system for clean work environment**
Sistem pengumpulan habuk yang cekap untuk mewujudkan persekitaran kerja bersih
高效的集尘系统打造清洁工作环境



Standard Equipment: Abrasive Belt, Carbon Plate, Step, Dust bag assembly



Continuous Rating Input Input Kuasa Berterusan 额定输入功率	940W
Belt Size Saiz Tali Pinggang 皮带尺寸	100 x 610mm (4" x 24")
Belt Speed Kelajuan Tali Pinggang 皮带速度	350m/min (1,150ft/min)
Overall Length Panjang Keseluruhan 总长度	374mm (14-3/4")
Net Weight Berat Bersih 净重	7.2kg (15.9lbs)
Power Supply Cord Kabel Wayar 电源线	5.0m (16.4ft)

9924DB 76mm x 610mm (3" x 24")

100 

Belt Sander Pengampelas 带式砂光机



- **Powerful 850W for fast material removal**
Motor berkuasa 750W untuk pengisaran yang lebih cepat
功率强大的 750W 马达提供更快的研磨



Standard Equipment: Abrasive Belt, Carbon Plate, Dust bag assembly



Continuous Rating Input Input Kuasa Berterusan 额定输入功率	850W
Belt Size Saiz Tali Pinggang 皮带尺寸	76 x 610, 620mm (3" x 24, 24-3/8")
Belt Speed Kelajuan Tali Pinggang 皮带速度	400m/min (1,300ft/min)
Overall Length Panjang Keseluruhan 总长度	355mm (14")
Net Weight Berat Bersih 净重	4.8kg (10.6lbs)
Power Supply Cord Kabel Wayar 电源线	5.0m (16.4ft)

9911 76mm x 457mm (3" x 18")

411 

Belt Sander Pengampelas 带式砂光机



- **Compact and well balanced for easy operation**
Padat dan mudah digunakan
紧凑且易于使用



Standard Equipment: Abrasive Belt, Dust bag assembly



Continuous Rating Input Input Kuasa Berterusan 额定输入功率	650W
Belt Size Saiz Tali Pinggang 皮带尺寸	76 x 457mm (3" x 18")
Belt Speed Kelajuan Tali Pinggang 皮带速度	75 - 270m/min (250 - 900ft/min)
Overall Length Panjang Keseluruhan 总长度	262mm (10-3/8")
Net Weight Berat Bersih 净重	2.7kg (6lbs)
Power Supply Cord Kabel Wayar 电源线	2.5m (8.2ft)

GRINDING | SANDING

9031 30mm x 533mm (1-3/16" x 21")

411

Belt Sander

Pengampelas
带式砂光机



- Versatile for use on wood, metal, and fiberglass materials
Digunakan pada bahan kayu, logam, dan gentian kaca
多用于木材、金属和纤维玻璃材料



Standard Equipment: Abrasive Belt x10, Side Handle



Continuous Rating Input Input Kuasa Berterusan 额定输入功率	550W
Belt Size Saiz Tali Pinggang 皮带尺寸	30 x 533mm (1-1/8" x 21")
Belt Speed Kelajuan Tali Pinggang 皮带速度	200 - 1,000m/min (656 - 3,280ft/min)
Overall Length Panjang Keseluruhan 总长度	380mm (15")
Net Weight Berat Bersih 净重	2.1kg (4.6lbs)
Power Supply Cord Kabel Wayar 电源线	2.5m (8.2ft)

BO3710

64

Finishing Sander

Pengampelas
砂光机



- High capacity dust bag with built-in vacuum adaptor for improved dust collection
Beg debu kapasiti tinggi dengan penyesuai vakum terbina dalam untuk pengumpulan habuk yang lebih baik
内置真空适配器的高容量集尘袋可改进集尘效果



Standard Equipment: Dust Bag, Punch Plate



Continuous Rating Input Input Kuasa Berterusan 额定输入功率	190W
Pad Size Saiz Pad 垫子尺寸	93 x 185mm (3-5/8" x 7-1/4")
Abrasive Paper Size Saiz Kertas Pasir 砂纸尺寸	93 x 228mm (3-5/8" x 9")
Orbits Per Minute (OPM) Bilangan Putaran 轨道转数	11,000
Strokes Per Minute (SPM) Kelajuan Strok 冲程速度	22,000
Orbit Diameter Jejaki Diameter 轨道直径	2.0mm (1/16")
Dimensions (L x W x H) Dimensi 体积	253x92x154mm (10"x3-5/8"x6-1/16")
Net Weight Berat Bersih 净重	1.6kg (3.5lbs)
Power Supply Cord Kabel Wayar 电源线	2.0m (6.6ft)

9035H

419

Finishing Sander

Pengampelas
砂光机



- Rubberized large paper clamp levers for easy installation/ removal of paper
Batang pengapit getah yang besar memudahkan pemasangan dan penyingkiran kertas pasir
大号橡胶夹杆方便安装及取出砂纸



Standard Equipment: Abrasive paper x6



Continuous Rating Input Input Kuasa Berterusan 额定输入功率	180W
Pad Size Saiz Pad 垫子尺寸	93 x 185mm (3-5/8" x 7-1/4")
Abrasive Paper Size Saiz Kertas Pasir 砂纸尺寸	93 x 228mm (3-5/8" x 9")
Orbits Per Minute (OPM) Kelajuan Ayunan 摆动速度	11,000
Dimensions (L x W x H) Dimensi 体积	236x93x146mm (9-1/4"x3-5/8"x5-3/4")
Net Weight Berat Bersih 净重	1.5kg (3.3lbs)
Power Supply Cord Kabel Wayar 电源线	2.5m (8.2ft)

BO4901

419

Finishing Sander

Pengampelas
砂光机



- Large clamp lever for easy install/ removal of paper
Batang pengapit yang besar memudahkan pemasangan dan penyingkiran kertas pasir
大夹紧杆方便安装及取出砂纸



Standard Equipment: Abrasive Paper



Continuous Rating Input Input Kuasa Berterusan 额定输入功率	330W
Pad Size Saiz Pad 垫子尺寸	115 x 229mm (4-1/2" x 9")
Abrasive Paper Size Saiz Kertas Pasir 砂纸尺寸	115 x 280mm (4-1/2" x 11")
Orbits Per Minute (OPM) Kelajuan Ayunan 摆动速度	10,000
Overall Length Panjang Keseluruhan 总长度	289mm (11-3/8")
Net Weight Berat Bersih 净重	2.8kg (6.2lbs)
Power Supply Cord Kabel Wayar 电源线	2.5m (8.2ft)

9045B 114mm (4-1/2")

105

Finishing Sander

Pengampelas
砂光机



- All bearing construction for smooth, long term operation
Konstruksi gais yang sesuai untuk operasi lancar dan jangka panjang
适合平滑及长期运行的轴承结构



Standard Equipment: Abrasive paper x10



Continuous Rating Input Input Kuasa Berterusan 额定输入功率	520W
Pad Size Saiz Pad 垫子尺寸	114 x 234mm (4-1/2" x 9-1/4")
Abrasive Paper Size Saiz Kertas Pasir 砂纸尺寸	114 x 280mm (4-1/2" x 11")
Orbits Per Minute (OPM) Kelajuan Ayunan 摆动速度	10,000
Overall Length Panjang Keseluruhan 总长度	240mm (9-1/2")
Orbit Diameter Jejaki Diameter 轨道直径	2.4mm (3/32")
Net Weight Berat Bersih 净重	2.6kg (5.7lbs)
Power Supply Cord Kabel Wayar 电源线	2.5m (8.2ft)

Cordless
Tali Wayar Bebas

LED Flashlight
Lampu Sali LED
LED BERTAMBAH

Vacuum Cleaner
Penyedut Habuk
VACUUM

Drilling / Fastening
Gigit / Pasang
MIL / 螺絲

Impact Drilling / Demolition
Gigit / Pasang
GILAS / 敲除

Cutting / Finishing
Potong / Hias
GILAS / 磨光

Grinding / Sanding
Tangkas / Pasir
MIL / 磨光

Sawing
Gigit
MIL

Planing / Roosting
Poli / Pasir / Tangkas
MIL / 磨光

Others
Lain-lain
MIL

Outdoor Power Equipment
Alatan Peralatan Luar
MIL / 户外

Makita
MIL

GRINDING | SANDING

BO4510H

419 W

Finishing Sander

Pengampelas
砂光机



• Large clamp lever for easy install/ removal of paper

Batang pengapit yang besar memudahkan pemasangan dan penyingkiran kertas pasir
大夹紧杆方便安装及取出砂纸

Standard Equipment: Abrasive paper x6



Continuous Rating Input Input Kuasa Berterusan 额定输入功率	170W
Pad Size Saiz Pad 垫子尺寸	110 x 100mm (4-5/16" x 3-15/16")
Abrasive Paper Size Saiz Kertas Pasir 砂纸尺寸	114 x 140mm (4-1/2" x 5-1/2")
Orbits Per Minute (OPM) Bilangan Putaran 轨道转速	12,000
Dimensions (L x W x H) Dimensi 体积	116x110x129mm (4-9/16"x4-5/16"x5-1/8")
Net Weight Berat Bersih 净重	1.1kg (2.4lbs)
Power Supply Cord Kabel Wayar 电源线	2.5m (8.2ft)

BO4556

419 W

Finishing Sander

Pengampelas
砂光机



• 14,000OPM for fast and smooth finish sanding

14,000OPM untuk pelicinan cepat dan lancar
14,000OPM可快速平顺的打磨

Standard Equipment: Abrasive Paper, Dust Bag, Punch Plate



Continuous Rating Input Input Kuasa Berterusan 额定输入功率	200W
Pad Size Saiz Pad 垫子尺寸	112 x 102mm (4-3/8" x 4")
Abrasive Paper Size Saiz Kertas Pasir 砂纸尺寸	114 x 140mm (4-1/2" x 5-1/2")
Orbits Per Minute (OPM) Bilangan Putaran 轨道转速	14,000
Dimensions (L x W x H) Dimensi 体积	131x112x141mm (5-1/8"x4-3/8"x5-9/16")
Net Weight Berat Bersih 净重	1.1kg (2.5lbs)
Power Supply Cord Kabel Wayar 电源线	2.0m (6.6ft)

BO6050J

325 W

Random Orbit Sander

Pengampelas
砂光机



• Slim skirt provides higher work efficiency in tight spaces

Kecekapan kerja yang lebih tinggi di ruang yang sempit
在狭小空间中提供更高的工作效率

Standard Equipment:
Abrasive Paper, Side Grip



BO6050

VIDEO CLIP
Models and specs may vary by country

Continuous Rating Input Input Kuasa Berterusan 额定输入功率	750W
Pad Diameter Saiz Pad 垫子尺寸	150mm (6")
Abrasive Disc Size Saiz Cakera 磨盘尺寸	150mm (6")
Orbits Per Minute (OPM) Bilangan Putaran 轨道转速	1,600 - 6,800
Sanding Strokes Per Minute (SPM) Menggilap Strok Seminit 每分钟打磨冲程	3,200 - 13,600
Pad Speed in Roto-orbit mode (rpm) Kelajuan Pad 垫速度	140 - 600
Orbit Diameter Jejaki Diameter 轨道直径	5.5mm (7/32")
Dimensions (L x W x H) Dimensi 体积	330x155x145mm (13"x6-1/8"x5-3/4")
Net Weight Berat Bersih 净重	2.6kg (5.7lbs)
Power Supply Cord Kabel Wayar 电源线	2.5m (8.2ft)

BO5031

419 W

Random Orbit Sander

Pengampelas
砂光机

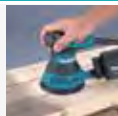

• Smooth finish with variable speed control

Kemasan lancar dengan kawalan kelajuan yang pelbagai
变速控制

Standard Equipment: Abrasive Paper, Dust Bag



Continuous Rating Input Input Kuasa Berterusan 额定输入功率	300W
Pad Diameter Saiz Pad 垫子尺寸	123mm (4-7/8")
Abrasive Disc Size Saiz Cakera 磨盘尺寸	125mm (5")
Orbits Per Minute (OPM) Bilangan Putaran 轨道转速	4,000-12,000
Dimensions (L x W x H) Dimensi 体积	153x123x153mm (6"x4-7/8"x6")
Net Weight Berat Bersih 净重	1.3kg (3lbs)
Power Supply Cord Kabel Wayar 电源线	2.0m (6.6ft)

BO5041

64 W

Random Orbit Sander

Pengampelas
砂光机



• More power for faster sanding and a smooth finish

Lebih berkuasa untuk pelicinan cepat dan lancar
更快速的打磨

Standard Equipment: Abrasive Paper, Dust Bag



Continuous Rating Input Input Kuasa Berterusan 额定输入功率	300W
Pad Diameter Saiz Pad 垫子尺寸	123mm (4-7/8")
Abrasive Disc Size Saiz Cakera 磨盘尺寸	125mm (5")
Orbits Per Minute (OPM) Bilangan Putaran 轨道转速	4,000-12,000
Dimensions (L x W x H) Dimensi 体积	218x123x153mm (8-5/8"x4-7/8"x6")
Net Weight Berat Bersih 净重	1.4kg (3.1lbs)
Power Supply Cord Kabel Wayar 电源线	2.0m (6.6ft)

SAWING

Gergaji 锯切



LS1019L 260mm (10-1/4")

153

Slide Compound Miter Saw

Gergaji Kompaun Miter
斜断锯



- **Large turn base supports workpiece securely for increased stability**
Dasar besar untuk menyokong bahan kerja dengan stabil
大转动底座稳定地支撑工件

Standard Equipment: EFFICUT Saw Blade, Dust Bag, Triangular Rule, Vertical Vise, Hex Wrench



Continuous Rating Input Input Kuasa Berterusan 额定输入功率	1,510W
Blade Diameter Diameter Bilah 锯片直径	260mm (10-1/4")
Bevel Angle Sudut Bevel 斜角	48°L / 48°R
Miter Angle Sudut Miter 斜接角	60°L / 60°R
Max Cutting Capacity Kapasiti Pemotongan Maksimum 最大切割能力	Crown Molding Vertically Nested: 168mm (6-5/8") Crown Molding Lying Flat: 248mm (9-3/4") Base Board Against Fence: 133mm (5-1/4") Base Board Lying Flat: 305mm (12")
No Load Speed (RPM) Kelajuan Tanpa Beban 回转数	3,200
Dimensions (L x W x H) Dimensi 体积	805x644x660mm (31-3/4"x25-3/8"x26")
Net Weight Berat Bersih 净重	26.3kg (57.9lbs.)
Power Supply Cord Kabel Wayar 电源线	2.5m (8.2ft.)

LS1219L 305mm (12")

153

Slide Compound Miter Saw

Gergaji Kompaun Miter
斜断锯



- **Dual dust collection ports provide excellent dust extraction performance**
Dua pengumpul habuk untuk prestasi pengekstrakan habuk yang sangat baik
双重集尘口提供出色的除尘性能

Standard Equipment: TCT Saw Blade (B-67474), Vertical Vise, Hex Wrench, Triangular Rule, Dust Bag



Continuous Rating Input Input Kuasa Berterusan 额定输入功率	1,800W
Blade Diameter Diameter Bilah 锯片直径	305mm (12")
Hole Diameter Diameter Lubang 孔直径	European Countries: 30mm (1-3/16") Others: 25.4mm (1")
Angle Sudut 角度	Bevel 48° L / 48° R Miter 60° L / 60° R
Max Cutting Capacity Kapasiti Pemotongan Maksimum 最大切割能力	Crown Molding Vertically Nested: 203mm (8") Crown Molding Lying Flat: 320mm (12-5/8") Base Board Against Fence: 171mm (6-3/4") Base Board Lying Flat: 416mm (16-3/8")
No Load Speed (RPM) Kelajuan Tanpa Beban 回转数	3,200
Dimensions (L x W x H) Dimensi 体积	898x664x725mm (35-1/4"x26-1/8"x28-1/2")
Net Weight Berat Bersih 净重	29.5kg (65.0lbs)
Power Supply Cord Kabel Wayar 电源线	2.5m (8.2ft)

LS1018L 260mm (10-1/4")

JM23000123

Slide Compound Saw

Gergaji Kompaun Miter
斜断锯



- **Large cutting capacity in a compact design and less weight**
Kapasiti pemotongan besar dalam reka bentuk kompak dan ringan
设计紧凑, 轻量, 切割能力大

Standard Equipment: TCT Saw Blade (B-14277), Vertical Vise, Socket Wrench, Triangular Rule, Dust Bag, Holder assembly



Continuous Rating Input Input Kuasa Berterusan 额定输入功率	1,430W
Blade Diameter Diameter Bilah 锯片直径	255 - 260mm (10 - 10-1/4")
Miter Angle Sudut Miter 斜接角	47°L / 60°R
Bevel Angle Sudut Bevel 斜角	45°L / 45°R
Max Cutting Capacity Kapasiti Pemotongan Maksimum 最大切割能力	90°: 91 x 305mm (3-5/8" x 12") 45°: 91 x 215mm (3-5/8" x 8-1/2")
No Load Speed (RPM) Kelajuan Tanpa Beban 回转数	4,300
Dimensions (L x W x H) Dimensi 体积	825x536x633mm (32-1/2"x21-1/8"x25")
Net Weight Berat Bersih 净重	20.6kg (45.4lbs)
Power Supply Cord Kabel Wayar 电源线	2.5m (8.2ft)

LS1040 260mm (10-1/4")

153

Compound Miter Saw

Gergaji Kompaun Miter
斜断锯



- **Powerful 1,650W direct drive motor for improved performance**
Motor 1,650W yang berkuasa meningkatkan prestasi
功率强劲的1.650W直驱马达提高了性能

Standard Equipment: Socket Wrench, Dust Bag, Holder Set, Vertical Vise, Triangular Rule



Continuous Rating Input Input Kuasa Berterusan 额定输入功率	1,650W
Blade Diameter Diameter Bilah 锯片直径	260mm (10-1/4")
Miter Angle Sudut Miter 斜接角	45°L / 52°R
Bevel Angle Sudut Bevel 斜角	45°L
Max Cutting Capacity Kapasiti Pemotongan Maksimum 最大切割能力	90°: 90.5 x 95mm (3-9/16" x 3-3/4") 45°: 90.5 x 67mm (3-9/16" x 2-5/8")
No Load Speed (RPM) Kelajuan Tanpa Beban 回转数	4,600
Dimensions (L x W x H) Dimensi 体积	530x476x532mm (20-7/8"x18-3/8"x21")
Net Weight Berat Bersih 净重	12.4kg (27.3lbs)
Power Supply Cord Kabel Wayar 电源线	2.5m (8.2ft)

Cordless
Tahan 4000 Bata

LED Flashlight
Lampu Suka LED
- 12308 BCT

Vacuum Cleaner
Penyedut Habuk
- 12309 BCT

Drilling / Fastening
Gergaji / Pasang
- 12310 BCT

Impact Drilling / Demolition
Gergaji / Hancurkan
- 12311 BCT

Cutting
Potong
- 12312 BCT

Grinding / Sanding
Gergaji / Pasang
- 12313 BCT

Sawing
Gergaji
- 12314 BCT

Others
Lain-lain
- 12315 BCT

Outdoor Power Equipment
Alatan Peralatan Luar
- 12316 BCT

Makita
- 12317 BCT

SAWING

LS0714 190mm (7-1/2")

153

Slide Compound Saw
Gergaji Kompau Miter
斜断锯



- Compact and Lightweight for Increased Jobsite Portability
Kompak dan Ringan
小巧轻便

Standard Equipment: Carbide-Tipped Saw Blade, Dust Bag, Holder Set, Vertical Vise, Triangular Rule



Continuous Rating Input Input Kuasa Berterusan 额定输入功率	1,010W
Blade Diameter Diameter Bilah 锯片直径	190mm (7-1/2")
Miter Angle Sudut Miter 斜接角	47°L / 57°R
Bevel Angle Sudut Bevel 斜角	45°L / 5°R
Max Cutting Capacity Kapasiti Pemotongan Maksimum 最大切割能力	90°: 52 x 300mm (2-1/16" x 11-3/4") 45°: 52 x 212mm (2-1/16" x 8-3/8")
No Load Speed (RPM) Kelajuan Tanpa Beban 回转速数	6,000
Dimensions (L x W x H) Dimensi 体积	670x430x458mm (26-3/8"x17"x18")
Net Weight Berat Bersih 净重	13.1kg (28.9lbs)
Power Supply Cord Kabel Wayar 电源线	2.5m (8.2ft)

LH1201FL 305mm (12")

JM23000123

Table Top Miter Saw
Gergaji Miter
两用平台斜切锯



- 2 tools in 1 for convenience and versatility
Alat 2 dalam 1
1机2用

Standard Equipment: TCT Saw Blade, Vertical Vise, Dust Bag, Rip Fence, Ring, Triangular Rule, Push Stick, Blade Cover, Socket Wrench, Holder Set



Continuous Rating Input Input Kuasa Berterusan 额定输入功率	1,650W
Blade Diameter Diameter Bilah 锯片直径	305mm (12")
Miter Angle Sudut Miter 斜接角	47°L / 52°R
Bevel Angle Sudut Bevel 斜角	45°L
Max Cutting Capacity Kapasiti Pemotongan Maksimum 最大切割能力	90°: 62 x 200mm (2-7/16" x 7-7/8") / 90°: 95 x 155mm (3-3/4" x 6-1/8") / 45° Miter, L/R: 62 x 135mm (2-7/16" x 5-5/16") / 45° Miter, L/R: 95 x 110mm (3-3/4" x 4-5/16") / 90°, Table saw: 52mm (2-1/16")
No Load Speed (RPM) Kelajuan Tanpa Beban 回转速数	3,800
Dimensions (L x W x H) Dimensi 体积	610x535x692mm (24"x21"x27-1/4") Table Size (W x L): 307 x 465mm (12-1/8" x 18-1/4")
Net Weight Berat Bersih 净重	20.9kg (46.1lbs)
Power Supply Cord Kabel Wayar 电源线	2.5m (8.2ft)

MAXIMUM CUTTING CAPACITY

Kapasiti Pemotongan Maksimum 最大切割能力

Model No.	Base Angle	Blade Angle Left 45°	Blade Angle 0°	Blade Angle Right 5°	Blade Angle Right 45°
LS0714	0°	40x300mm	52x300mm	40x300mm	-
	Left / Right 45°	40x212mm	52x212mm	-	-
	-	-	-	-	-
	Right 57°	-	52x163mm	-	-
LS1018L	0°	50x305mm	91x305mm	-	31x305mm
	Left / Right 45°	50x215mm	91x215mm	-	31x215mm
	-	-	-	-	-
	Right 60°	-	91x150mm	-	-
LS1019L	0°	47x305, 61x279mm	71x305, 91x279mm	-	29x305, 43x279mm
	Left / Right 45°	47x215, 61x197mm	71x215, 91x197mm	-	29x215, 43x197mm
	Left / Right 60°	-	71x152, 91x139mm	-	-
	-	-	-	-	-
LS1219L	0°	71x363mm	107x363mm	-	54x363mm
	Left / Right 45°	71x255mm	107x255mm	-	54x255mm
	Left / Right 60°	-	107x178mm	-	-
	-	-	-	-	-
LS1040	0°	48x95mm	90.5x95mm	-	-
	Left / Right 45°	48x67mm	90.5x67mm	-	-
	-	-	-	-	-
	-	-	-	-	-
LH1201FL	0°	64x155mm	95x155mm	-	-
	Left 45°	64x65mm	95x110mm	-	-
	Right 45°	40x125mm	95x110mm	-	-
	Cutting capacity as table saw: 52mm	-	-	-	-
LS1440	-	-	122x152mm	-	-
	-	-	122x115mm	-	-
	-	-	-	-	-
	-	-	-	-	-
LS1030N	-	-	90.5x95mm	-	-
	-	-	90.5x67mm	-	-
	-	-	-	-	-
	-	-	-	-	-
LF1000	-	-	20x210mm	-	-
	-	-	68x155mm	-	-
	-	-	50x150mm	-	-
	-	-	-	-	-

Cordless
Three Point Mount
LED Flashlight
Lamp
Vacuum Cleaner
Drilling / Fastening
Impact Drilling / Demolition
Cutting
Grinding / Sanding
Sawing
Planing / Routing
Others
Outdoor Power Equipment



SAWING

LS1440 355mm (14")

153

Miter Saw Gergaji Miter 斜断锯

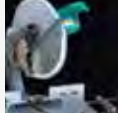

- **Large cutting capacity**
Kapasiti pemotongan besar
大切割能力

Standard Equipment: Socket Wrench, Vise Assembly, Dust Bag, Holder Set



Continuous Rating Input Input Kuasa Berterusan 额定输入功率	1,380W
Max Cutting Capacity Kapasiti Pemotongan Maksimum 最大切割能力	90°: 122 x 152mm (4-13/16" x 6") 45°: 122 x 115mm (4-13/16" x 4-1/2")
Blade Diameter Diameter Bilah 锯片直径	355mm (14")
No Load Speed (RPM) Kelajuan Tanpa Beban 回转数	3,200
Dimensions (L x W x H) Dimensi 体积	530x596x435mm (20-7/8"x23-1/2"x17-1/8")
Net Weight Berat Bersih 净重	34.2kg (75.4lbs)
Power Supply Cord Kabel Wayar 电源线	2.5m (8.2ft)

LS1030N 260mm (10-1/4")

153

Miter Saw Gergaji Miter 斜断锯

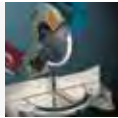

- **Miter cuts 0°-45° left and 0°-52° right**
Serong 0° -45° ke kiri dan 0° -52° ke kanan
斜切向左 0° -45° 和向右 0° -52°

Standard Equipment: Socket Wrench, Dust Bag, Triangular Rule



Continuous Rating Input Input Kuasa Berterusan 额定输入功率	1,650W
Blade Diameter Diameter Bilah 锯片直径	260mm (10-1/4")
Max Cutting Capacity Kapasiti Pemotongan Maksimum 最大切割能力	90°: 90.5 x 95mm (3-9/16" x 3-3/4") 45°: 90.5 x 67mm (3-9/16" x 2-5/8")
No Load Speed (RPM) Kelajuan Tanpa Beban 回转数	4,600
Dimensions (L x W x H) Dimensi 体积	530x476x532mm (20-7/8"x18-3/4"x21")
Net Weight Berat Bersih 净重	12.1kg (26.7lbs.)
Power Supply Cord Kabel Wayar 电源线	2.5m (8.2ft)

LF1000 260mm (10-1/4")

153

Flip Over Saw Gergaji Flip 翻转锯



- **Quick miter saw/ table saw conversion**
Konversi gergaji miter & gergaji meja
斜断锯及台锯快速转换

Standard Equipment: Rip Fence, Miter Gauge, Push Stick, Top Cover Assy (Top Blade Guard), Dust Cover, Dust Bag, Wrench 8



Continuous Rating Input Input Kuasa Berterusan 额定输入功率	1,650W
Max Cutting Capacity Kapasiti Pemotongan Maksimum 最大切割能力	90°: 20 x 210mm (13/16" x 8-1/4") 90°: 68 x 155mm (2-11/16" x 6-1/8") 45°: 50 x 150mm (2" x 5-7/8")
Blade Diameter Diameter Bilah 锯片直径	260mm (10-1/4")
No Load Speed (RPM) Kelajuan Tanpa Beban 回转数	2,700
Dimensions (L x W x H) Dimensi 体积	Miter saw : 660x650x1,220mm (26"x25-1/2"x48") Table saw : 660x650x1,060mm (26"x25-1/2"x41-3/4")
Net Weight Berat Bersih 净重	36.0 kg (79.4 lbs)
Power Supply Cord Kabel Wayar 电源线	2.5 m (8.2 ft)

2704 260mm (10-1/4")

153

Table Saw Gergaji Meja 台锯



- **Electric brake for increased productivity and operator safety**
Brek Elektrik untuk peningkatan produktiviti dan pengendalian keselamatan
电子自动刹车提高生产率和操作安全

Standard Equipment: Carbide-Tipped Saw Blade (B-17734), Rip Fence, Miter Gauge, Wrenches, Push Stick, Ring



Continuous Rating Input Input Kuasa Berterusan 额定输入功率	1,650W
Max Cutting Capacity Kapasiti Pemotongan Maksimum 最大切割能力	90°: 93mm (3-5/8") 45°: 64mm (2-1/2")
Blade Diameter Diameter Bilah 锯片直径	260mm (10-1/4")
No Load Speed (RPM) Kelajuan Tanpa Beban 回转数	4,800
Dimensions (L x W x H) Dimensi 体积	665x766x344mm (26-1/4"x30-1/4"x13-1/2")
Net Weight Berat Bersih 净重	35.6 - 37.3kg (78.5 - 82.3lbs.)
Power Supply Cord Kabel Wayar 电源线	2.5m (8.2ft)

MLT100 260mm (10-1/4")

Table Saw Gergaji Meja 台锯



- **Right and rear extension table enables greater cutting capacity**
Meja tambahan kanan dan belakang membolehkan kapasiti pemotongan yang lebih besar
右侧和后侧延伸台具有更大的切割能力

Standard Equipment: Carbide-Tipped Saw Blade, Rip Fence, Miter Gauge, Wrenches, Push Stick, Triangular Rule



Continuous rating input Input Kuasa Berterusan 额定输入功率	1,500W
Max Cutting Capacity Kapasiti Pemotongan Maksimum 最大切割能力	90°: 91mm (3-9/16") 45°: 63mm (2-1/2")
Blade Diameter Diameter Bilah 锯片直径	260mm (10-1/4")
No Load Speed (RPM) Kelajuan Tanpa Beban 回转数	4,300
Dimensions (L x W x H) Dimensi 体积	726x984x333mm (28-1/2"x38-3/4"x13-1/8")
Net weight Berat Bersih 净重	34.1kg (75.2lbs)
Power supply cord Kabel Wayar 电源线	2.5m (8.2ft)

Cordless
Tutupi 4000 10.8V

LED Flashlight
Lampu Senter LED
- LED 3000 BRIGHT

Vacuum Cleaner
Penyedut Debu
- 10.8V

Drilling / Fastening
Gergaji / Pengikat
- 10.8V

Impact Drilling / Demolition
Gergaji / Penanggal
- 10.8V

2 in 1
Flipper

Cutting
Pemotong
- 10.8V

Grinding / Sanding
Gergaji / Gergaji
- 10.8V

Sawing
Gergaji
- 10.8V

Planing / Routing
Pengaliran / Pengaliran
- 10.8V

Others
Lain-lain
- 10.8V

Outdoor Power Equipment
Alatan Peralatan Luar
- 10.8V

Makita
- 10.8V

SAWING

2712 315mm (12-3/8")

Table Saw

Gergaji Meja
台锯



- **Powerful 2,000W motor for fast cutting**
Motor berkuasa 2,000W untuk pemotongan pantas
功能强大的2,000W马达快速切割

Standard Equipment: Carbide-Tipped Saw Blade, Rip Fence, Miter Gauge, Wrenches, Push Stick, Ring



Max Cutting Capacity Kapasiti Pemotongan Maksimum 最大切割能力	90°: 85mm (3-3/8") 45°: 58mm (2-1/4")
Blade Diameter Diameter Bilah 锯片直径	315mm (12-3/8")
No Load Speed (RPM) Kelajuan Tanpa Beban 回转速	50Hz: 2,950 60Hz: 3,400
Bevel Capacity Kapasiti Bevel 斜角容量	0° - 45°
Dimensions (L x W x H) Dimensi 体积	1,670x700x810mm (65-3/4"x27-1/2"x32")
Net weight Berat Bersih 淨重	54kg (118.9lbs)
Power supply cord Kabel Wayar 电源线	3.0m (9.8ft)

HS6100 165mm (6-1/2")

174 W

Circular Saw

Gergaji Piring
圆锯



- **Smooth cutting at high rotational speed**
Pemotongan licin pada kelajuan putaran tinggi
在高转速下平滑切割

Standard Equipment: Carbide-Tipped Saw Blade (B-02917), Hex Wrench, Rip Fence (Guide Rule), Dust Nozzle (195801-0)



Continuous Rating Input Input Kuasa Berterusan 额定输入功率	1,100W
Blade Diameter Diameter Bilah 锯片直径	165mm (6-1/2")
Max Cutting Capacity Kapasiti Pemotongan Maksimum 最大切割能力	90°: 54.5mm (2-1/8")/ 45°: 39.5mm (1-9/16")/ 50°: 35.5mm (1-3/8")
No Load Speed (RPM) Kelajuan Tanpa Beban 回转速	5,500
Dimensions (L x W x H) Dimensi 体积	297x246x246mm (11-3/4"x9-11/16"x9-11/16")
Net Weight Berat Bersih 淨重	3.5kg (7.7lbs)
Power Supply Cord Kabel Wayar 电源线	2.5m (8.2ft)

HS6600 165mm (6-1/2")

303 W

Circular Saw

Gergaji Piring
圆锯



- **More compact and lightweight design**
Reka bentuk lebih padat dan ringan
更小巧轻便的设计

Standard Equipment: Rip Fence (Guide Rule), TCT Saw Blade (B-02917), Hex Wrench



Continuous Rating Input Input Kuasa Berterusan 额定输入功率	1,050W
Blade Diameter Diameter Bilah 锯片直径	165mm (6-1/2")
Max Cutting Capacity Kapasiti Pemotongan Maksimum 最大切割能力	90°: 54.5mm (2-1/8") 45°: 37.5mm (1-1/2")
No Load Speed (RPM) Kelajuan Tanpa Beban 回转速	5,200
Dimensions (L x W x H) Dimensi 体积	296x230x243mm (11-5/8"x9"x9-9/16")
Net Weight Berat Bersih 淨重	3.5kg (7.6lbs)
Power Supply Cord Kabel Wayar 电源线	2.5m (8.2ft)

HS7010 185mm (7-1/4") / 190mm (7-1/2")

303 W

Circular Saw

Gergaji Piring
圆锯



- **High Power and Increased Motor-Burnout Resistance**
Berkuasa Tinggi
高功率

Standard Equipment: TCT Saw Blade, Rip Fence (Guide Rule), Hex Wrench



Continuous Rating Input Input Kuasa Berterusan 额定输入功率	1,600W
Blade Diameter Diameter Bilah 锯片直径	185/ 190mm (7-1/4"/ 7-1/2")
Max Cutting Capacity Kapasiti Pemotongan Maksimum 最大切割能力	90°: 65/ 67mm (2-9/16"/ 2-5/8") 45°: 44/ 45mm (1-3/4"/ 1-3/4")
No Load Speed (RPM) Kelajuan Tanpa Beban 回转速	5,500
Dimensions (L x W x H) Dimensi 体积	300x240x261mm (11-3/4"x9-1/2"x10-1/4")
Net Weight Berat Bersih 淨重	4.0kg (8.9lbs)
Power Supply Cord Kabel Wayar 电源线	2.5m (8.2ft)

HS7600 185mm (7-1/4")

303 W

Circular Saw

Gergaji Piring
圆锯



- **Powerful 1,200W motor**
Motor berkuasa 1,200W
动力1,200W马达

Standard Equipment: TCT Saw Blade, Rip Fence (Guide Rule), Hex Wrench



Continuous Rating Input Input Kuasa Berterusan 额定输入功率	1,200W
Blade Diameter Diameter Bilah 锯片直径	185mm (7-1/4")
Max Cutting Capacity Kapasiti Pemotongan Maksimum 最大切割能力	90°: 64mm (2-1/2") 45°: 42mm (1-5/8")
No Load Speed (RPM) Kelajuan Tanpa Beban 回转速	5,200
Dimensions (L x W x H) Dimensi 体积	309x234x255mm (12-1/8"x9-1/4"x10")
Net Weight Berat Bersih 淨重	3.8kg (8.3lbs)
Power Supply Cord Kabel Wayar 电源线	2.5m (8.2ft)

Cordless
Three Point Mount

LED Flashlight
Lampu Bercahaya LED
1500000 BT

Vacuum Cleaner
Penyedut Debu Vakuum
2000 BT

Drilling / Fastening
Drool / Pasang
M.M. / M.M.

Impact Drilling / Demolition
Drool / Pecutan
M.M. / M.M.

Cutting / Finishing
Drool / Hias
M.M. / M.M.

Trimming / Sanding
Drool / Hias
M.M. / M.M.

Sawing / Usage
Drool / Hias
M.M. / M.M.

Planting / Routing
Drool / Hias
M.M. / M.M.

Others
Lain-lain
M.M. / M.M.

Outdoor Power Equipment
Alat Berkuasa Luar
M.M. / M.M.

Makita
M.M. / M.M.

SAWING

5806B 185mm (7-1/4")

303

Circular Saw Gergaji Piring 圆锯



- **Powerful motor for smooth operation even in heavy duty cutting**
Motor berkuasa untuk operasi lancar walaupun dalam pemotongan tugas berat
强大的马达即使在重型切割中也可以平稳运行

Standard Equipment: Carbide-Tipped Saw Blade, Hex Wrench, Rip Fence (Guide Rule)



Continuous Rating Input Input Kuasa Berterusan 额定输入功率	1,050W
Blade Diameter Diameter Bilah 锯片直径	185mm (7-1/4")
Max Cutting Capacity Kapasiti Pemotongan Maksimum 最大切割能力	90°: 66mm (2-5/8") 45°: 44mm (1-11/16")
No Load Speed (RPM) Kelajuan Tanpa Beban 回转数	5,200
Overall Length Panjang Keseluruhan 总长度	282mm (11-1/8")
Net Weight Berat Bersih 净重	3.5kg (7.6lbs)
Power Supply Cord Kabel Wayar 电源线	2.5m (8.2ft)

5008MG 210mm (8-1/4")

153

Circular Saw Gergaji Piring 圆锯



- **Powerful 1,800W motor for proven performance**
Motor berkuasa 1,800W untuk prestasi yang terbukti
功率强大的1,800W马达，性能可靠

Standard Equipment: TCT Saw Blade (D-29066), Hex Wrench, Rip Fence (Guide Rule)



Continuous Rating Input Input Kuasa Berterusan 额定输入功率	1,800W
Blade Diameter Diameter Bilah 锯片直径	210mm (8-1/4")
Max Cutting Capacity Kapasiti Pemotongan Maksimum 最大切割能力	90°: 75.5mm (3") 45°: 57mm (2-1/4") 50°: 51.5mm (2")
No Load Speed (RPM) Kelajuan Tanpa Beban 回转数	5,200
Dimensions (L x W x H) Dimensi 体积	332x243x277mm (13-1/8"x9-9/16"x10-7/8")
Net Weight Berat Bersih 净重	4.8kg (10.6lbs)
Power Supply Cord Kabel Wayar 电源线	2.5m (8.2ft)

N5900B 235mm (9-1/4")

153

Circular Saw Gergaji Piring 圆锯



- **High power 2,000W to rip through most materials**
Kuasa tinggi 2,000W untuk pemotongan pelbagai bahan
大功率2000W可以切割大部分材料

Standard Equipment: Carbide-Tipped Saw Blade, Rip Fence (Guide Rule), Wrench 13



Continuous Rating Input Input Kuasa Berterusan 额定输入功率	2,000W
Max Cutting Capacity Kapasiti Pemotongan Maksimum 最大切割能力	90°: 85mm (3-3/8") 45°: 60mm (2-3/8") 50°: 53mm (2-1/16")
Blade Diameter Diameter Bilah 锯片直径	235mm (9-1/4")
No Load Speed (RPM) Kelajuan Tanpa Beban 回转数	4,100
Overall Length Panjang Keseluruhan 总长度	380mm (15")
Net Weight Berat Bersih 净重	6.8kg (14.8lbs)
Power Supply Cord Kabel Wayar 电源线	2.5m (8.2ft)

HS0600 260mm (10-1/4")/ 270mm (10-5/8")

153

Circular Saw Gergaji Piring 圆锯



- **Powerful 2,100W motor**
Motor berkuasa 2,100W
强力2,100W马达

Standard Equipment: TCT Saw Blade, Rip Fence (Guide Rule), Hex Wrench



Continuous Rating Input Input Kuasa Berterusan 额定输入功率	2,000W
Blade Diameter Diameter Bilah 锯片直径	260/ 270mm (10-1/4" / 10-5/8")
Max Cutting Capacity Kapasiti Pemotongan Maksimum 最大切割能力	90°: 97/ 101mm (3-13/16" / 4") 45°: 68/ 71mm (2-11/16" / 2-13/16") 50°: 61/ 63mm (2-3/8" / 2-1/2")
No Load Speed (RPM) Kelajuan Tanpa Beban 回转数	4,300
Dimensions (L x W x H) Dimensi 体积	418x273x324mm (16-1/2"x10-3/4"x12-3/4")
Net Weight Berat Bersih 净重	6.9kg (15.2lbs)
Power Supply Cord Kabel Wayar 电源线	2.5m (8.2ft)

5103N 335mm (13-1/8")

153

Circular Saw Gergaji Piring 圆锯



- **Smooth cutting at high rotational speed**
Pemotongan licin pada kelajuan putaran tinggi
在高转速下平滑切割

Standard Equipment: Wrench, Rip Fence (Guide Rule)

Continuous Rating Input Input Kuasa Berterusan 额定输入功率	1,750W
Blade Diameter Diameter Bilah 锯片直径	335mm (13-1/8")
Max Cutting Capacity Kapasiti Pemotongan Maksimum 最大切割能力	90°: 128mm (5") 45°: 91mm (3-5/8")
No Load Speed (RPM) Kelajuan Tanpa Beban 回转数	2,900
Overall Length Panjang Keseluruhan 总长度	505mm (19-7/8")
Net Weight Berat Bersih 净重	8.9kg (19.6lbs)
Power Supply Cord Kabel Wayar 电源线	5.0m (16.4ft)

Cordless
Tutupi 4000 10.8V

LED Flashlight
Lampu Suka LED
- 12.0V 10.8V

Vacuum Cleaner
Penyedut Debu
- 12.0V

Drilling / Fastening
Gergaji / Pengikat
- 12.0V

Impact Drilling / Demolition
Gergaji / Penyerut
- 12.0V

Impact Drilling / Demolition
Gergaji / Penyerut
- 12.0V

Cutting
Pemotong
- 12.0V

Grinding / Sanding
Gergaji / Pasir
- 12.0V

Sawing
Gergaji
- 12.0V

Planing / Routing
Pengaliran / Rute
- 12.0V

Others
Lain-lain
- 12.0V

Outdoor Power Equipment
Alatan Peralatan Luar
- 12.0V

Makita
- 12.0V

SAWING

5402 415mm (16-5/16")

153 W

Circular Saw

Gergaji Piring
圆锯



- **Smooth cutting at high rotational speed**
Pemotongan licin pada kelajuan putaran tinggi
在高转速下平滑切割

Standard Equipment: Combination Saw Blade, Hex Wrench, Rip Fence (Guide Rule)

Blade Diameter Diameter Bilah 锯片直径	415mm (16-5/16")
Max Cutting Capacity Kapasiti Pemotongan Maksimum 最大切割能力	90°: 157mm (6-3/16") 45°: 106mm (4-3/16")
No Load Speed (RPM) Kelajuan Tanpa Beban 回转速数	2,200
Overall Length Panjang Keseluruhan 总长度	615mm (24-1/4")
Net Weight Berat Bersih 净重	12.9kg (28.4lbs)
Power Supply Cord Kabel Wayar 电源线	5.0m (16.4ft)

SP6000J 165mm (6-1/2")

303 W

Plunge Cut Circular Saw

Gergaji Piring
圆锯



- **Built-in current limiter helps prevent motor burnout**
Pengehad arus terbina dalam mencegah motor dari terbakar
电流限制器有助于防止马达烧毁

Standard Equipment: TCT Saw Blade (B-07353), Hex Wrench

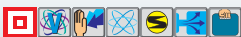

Continuous Rating Input Input Kuasa Berterusan 额定输入功率	1,300W
Blade Diameter Diameter Bilah 锯片直径	165mm (6-1/2")
Max Cutting Capacity Kapasiti Pemotongan Maksimum 最大切割能力	90°: 56mm (2-3/16") 45°: 40mm (1-9/16") 48°: 38mm (1-1/2")
No Load Speed (RPM) Kelajuan Tanpa Beban 回转速数	2,000 - 5,800
Dimensions (L x W x H) Dimensi 体积	341x225x250mm (13-3/8"x8-7/8"x9-7/8")
Net Weight Berat Bersih 净重	4.1kg (9lbs)
Power Supply Cord Kabel Wayar 电源线	2.5m (8.2ft)

4329

64 W

Jig Saw

Gergaji Jig
线锯机



- **Bevel cuts to 45° right or left and positive stop at 90° for solid cutting performance**
Kelajuan tinggi dan kecekapan tinggi
高速与高效率

Standard Equipment: Jig Saw Blade (B-10), Hex Wrench



Continuous Rating Input Input Kuasa Berterusan 额定输入功率	450W
Max Cutting Capacity at 90° Kapasiti Pemotongan Maksimum 最大切割能力	Wood: 65 mm (2-9/16") Steel: 6 mm (1/4")
Length of Stroke Panjang Strok 冲程长度	18 mm (11/16")
Strokes Per Minute (SPM) Kelajuan Strok 冲程速度	500 - 3,100
Dimensions (L x W x H) Dimensi 体积	223x77x197mm (8-3/4"x3"x7-3/4")
Net Weight Berat Bersih 净重	1.9kg (4.2lbs.)
Power Supply Cord Kabel Wayar 电源线	2.0m (6.6ft)

4350CT

419 W

Jig Saw

Gergaji Jig
线锯机



- **3 orbital settings plus straight cutting with a powerful 720W motor**
3 tetapan orbital serta pemotongan lurus dengan motor berkuasa 720W
强大的720W马达, 3个轨道设置与直切割

Standard Equipment: Hex Wrench, Cover Plate, Anti-Splintering Device, Jig Saw Blade Set (No. B-10, BR-13, B-22, 2pcs each)



Continuous Rating Input Input Kuasa Berterusan 额定输入功率	720W
Capacity Kapasiti 能力	Wood: 135mm (5-5/16") Steel: 10mm (3/8")
Length of Stroke Panjang Strok 冲程长度	26mm (1")
Strokes Per Minute (SPM) Kelajuan Strok 冲程速度	800 - 2,800
Dimensions (L x W x H) Dimensi 体积	236x73x207mm (9-1/4"x2-7/8"x8-1/8")
Net Weight Berat Bersih 净重	2.7kg (5.8lbs)
Power Supply Cord Kabel Wayar 电源线	2.5m (8.2ft)

4351CT

419 W

Jig Saw

Gergaji Jig
线锯机



- **Bevel cuts to 45° right or left and positive stop at 90° for solid cutting performance**
Potongan serong ke 45° kanan atau kiri dan berhenti positif pada 90° untuk prestasi pemotongan pepejal
斜面切割45°左右, 90°正向切割, 切割性能稳定

Standard Equipment: Hex Wrench, Cover Plate, Anti-Splintering Device, Jig Saw Blade Set (No. B-10, BR-13, B-22, 2pcs each)



Continuous Rating Input Input Kuasa Berterusan 额定输入功率	720W
Capacity Kapasiti 能力	Wood: 135mm (5-5/16") Steel: 10mm (3/8")
Length of Stroke Panjang Strok 冲程长度	26 mm (1")
Strokes Per Minute (SPM) Kelajuan Strok 冲程速度	800 - 2,800
Dimensions (L x W x H) Dimensi 体积	271x73x187mm (10-11/16"x2-7/8"x7-3/8")
Net Weight Berat Bersih 净重	2.6kg (5.7lbs)
Power Supply Cord Kabel Wayar 电源线	2.5m (8.2ft)

Cordless
Three Point Mount

LED Flashlight
Lampu Bercahaya LED
1500000 BT

Vacuum Cleaner
Penyedut A Vakuum
1500 BT

Drilling / Fastening
Druai / Pasang
1500 BT

Impact Drilling / Demolition
Druai / Pecutan
1500 BT

Cutting / Finishing
Druai
1500 BT

Trimming / Sanding
Pengira / Tapis
1500 BT

Sawing / Usage
Druai
1500 BT

Planting / Routing
Druai / Tapis
1500 BT

Others
Lain-lain
1500 BT

Outdoor Power Equipment
Alat Kuasa Luar
1500 BT

Makita
1500 BT

SAWING

JV0600K

64

Jig Saw Gergaji Jig 线锯机



- **Toolless blade change system for fast blade installation and removal**
Penukaran bilah tanpa alat untuk pemasangan bilah cepat
无需工具更换刀片，可快速安装和拆卸刀片

Standard Equipment: Jig Saw Blade, Hex Wrench



Continuous Rating Input Input Kuasa Berterusan 额定输入功率	650W
Capacity Kapasiti 能力	Wood: 90mm (3-1/2") Steel: 10mm (3/8")
Length of Stroke Panjang Strok 冲程长度	23mm (7/8")
Strokes Per Minute (SPM) Kelajuan Strok 冲程速度	500 - 3,100
Dimensions (L x W x H) Dimensi 体积	236x77x199mm (9-1/4"x3"x7-7/8")
Net Weight Berat Bersih 净重	2.4kg (5.3lbs)
Power Supply Cord Kabel Wayar 电源线	2.5m (8.2ft)

4327M

64

Jig Saw Gergaji Jig 线锯机

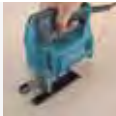

- **High power and Lightweight**
Kuasa tinggi dan Ringan
高功率和轻量

Standard Equipment: Jig Saw Blade, Hex Wrench



Continuous Rating Input Input Kuasa Berterusan 额定输入功率	450W
Capacity Kapasiti 能力	Wood: 40mm (1-9/16") Steel: 6mm (1/4")
Length of Stroke Panjang Strok 冲程长度	18mm (11/16")
Strokes Per Minute (SPM) Kelajuan Strok 冲程速度	500 - 3,100
Dimensions (L x W x H) Dimensi 体积	224x77x197mm (8-7/8"x3"x7-3/4")
Net Weight Berat Bersih 净重	1.8kg (4.0lbs)
Power Supply Cord Kabel Wayar 电源线	2.0m (6.6ft)

4327

64

Jig Saw Gergaji Jig 线锯机

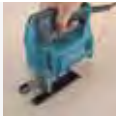

- **High power and Lightweight**
Kuasa tinggi dan Ringan
高功率和轻量

Standard Equipment: Jig Saw Blade, Hex Wrench



Continuous Rating Input Input Kuasa Berterusan 额定输入功率	450W
Capacity Kapasiti 能力	Wood: 65mm (2-9/16") Steel: 6mm (1/4")
Length of Stroke Panjang Strok 冲程长度	18mm (11/16")
Strokes Per Minute (SPM) Kelajuan Strok 冲程速度	500 - 3,100
Dimensions (L x W x H) Dimensi 体积	224x77x197mm (8-7/8"x3"x7-3/4")
Net Weight Berat Bersih 净重	1.9kg (4.2lbs)
Power Supply Cord Kabel Wayar 电源线	2.0m (6.6ft)

4300BV

51

Jig Saw Gergaji Jig 线锯机



- **Robust construction and strength to cut through a wide range of materials**
Pembinaan yang kukuh dengan kekuatan untuk memotong pelbagai bahan
坚固的结构和强度可切割各种材料

Standard Equipment: Jig saw blade set, Rip Fence (Guide Rule), Circular Guide, Hex Wrench



Continuous Rating Input Input Kuasa Berterusan 额定输入功率	390W
Capacity Kapasiti 能力	Wood: 55mm (2-1/8") Steel: 6mm (1/4")
Length of Stroke Panjang Strok 冲程长度	26mm (1")
Strokes Per Minute (SPM) Kelajuan Strok 冲程速度	0-3,100
Overall Length Panjang Keseluruhan 总长度	225mm (8-7/8")
Net Weight Berat Bersih 净重	2.5kg (5.5lbs)
Power Supply Cord Kabel Wayar 电源线	2.5m (8.2ft)

JR3050T

303

Recipro Saw Gergaji Resipro 往复锯



- **Ideal for framers, carpenters, electricians, plumbers and general construction**
Untuk framers, tukang kayu, juruelektrik, tukang paip dan pembinaan umum
木工，木匠，电工，水管工和一般建筑的理想选择

Standard Equipment: Recipro Saw Blades 3pcs (No. 21, 22, 23)



Continuous Rating Input Input Kuasa Berterusan 额定输入功率	1,010W
Length of Stroke Panjang Strok 冲程长度	28mm (1-1/8")
Strokes Per Minute (SPM) Kelajuan Strok 冲程速度	0 - 2,800
Capacity Kapasiti 能力	Pipe : 130mm (3-1/2") Wood: 255mm (10")
Overall Length Panjang Keseluruhan 总长度	452mm (17-3/4")
Net Weight Berat Bersih 净重	3.3kg (7.3lbs)
Power Supply Cord Kabel Wayar 电源线	2.5m (8.2ft)

Cordless
Tali Wayar Tanpa Tali

LED Flashlight
Lampu Sorot LED
- LED LIGHT

Vacuum Cleaner
Penyedut Debu
- VACUUM

Drilling / Fastening
Gergaji / Pasang
- DRILLING

Impact Drilling / Demolition
Gergaji / Hancurkan
- IMPACT

Cutting
Memotong
- CUTTING

Grinding / Sanding
Moles / Pasir
- GRINDING

Sawing
Gergaji
- SAWING

Planing / Routing
Moles / Ratakan
- PLANING

Others
Lain-lain
- OTHERS

Outdoor Power Equipment
Alat-alat Berdaya Luar
- OUTDOOR

Makita
- MAKITA

SAWING

JR3051TK

303 WATT

Recipro Saw Gergaji Resipro 往复锯



- **Powerful 1,200W motor for improved performance**
Meningkatkan prestasi dengan motor 1,200W
强大的1,200W电机可提高性能



Standard Equipment: Recipro Saw Blades 3pcs (No. 21, 22, 23)



Continuous Rating Input Input Kuasa Berterusan 额定输入功率	1,200W
Length of Stroke Panjang Strok 冲程长度	30mm (1-3/16")
Strokes Per Minute (SPM) Kelajuan Strok 冲程速度	0 - 3,000
Capacity Kapasiti 能力	Pipe: 130mm (5-1/8") Wood: 255mm (10")
Dimensions (L x W x H) Dimensi 体积	447x97x176mm (17-5/8"x3-13/16"x6-15/16")
Net Weight Berat Bersih 淨重	3.2 - 3.3kg (7.1 - 7.3lbs.)
Power Supply Cord Kabel Wayar 电源线	2.5m (8.2ft)

JR3061T

303 WATT

Recipro Saw Gergaji Resipro 往复锯



- **Higher cutting efficiency & Excellent durability**
Kecekapan pemotongan yang lebih tinggi dan ketahanan yang sangat baik
更高的切割效率和卓越的耐用性



Standard Equipment: Recipro Saw Blades



Continuous Rating Input Input Kuasa Berterusan 额定输入功率	1,250W
Length of Stroke Panjang Strok 冲程长度	32mm (1-1/4")
Strokes Per Minute (SPM) Kelajuan Strok 冲程速度	0 - 3,000
Capacity Kapasiti 能力	Pipe: 130mm (5-1/8") Wood: 255mm (10")
Dimensions (L x W x H) Dimensi 体积	487x95x177mm (19-3/16"x3-3/4"x7")
Net Weight Berat Bersih 淨重	3.8kg (8.4lbs.)
Power Supply Cord Kabel Wayar 电源线	2.5m (8.2ft)

JR3070CT

303 WATT

Recipro Saw Gergaji Resipro 往复锯



- **Anti-Vibration Technology for 2X Less Vibration**
Mengurangkan getaran 2X dengan teknologi anti getaran
2倍减振的防振技术



Standard Equipment: Recipro Saw Blades 3pcs



Continuous Rating Input Input Kuasa Berterusan 额定输入功率	1,510W
Length of Stroke Panjang Strok 冲程长度	32mm (1-1/4")
Strokes Per Minute (SPM) Kelajuan Strok 冲程速度	0 - 2,800
Capacity Kapasiti 能力	Pipe : 130mm (5-1/8") Wood: 255mm (10")
Overall Length Panjang Keseluruhan 总长度	485mm (19-1/8")
Net Weight Berat Bersih 淨重	4.6kg (10lbs)
Power Supply Cord Kabel Wayar 电源线	2.5m (8.2ft)

SJ401

Scroll Saw Gergaji Scroll 平台式線鋸機



- **Bevel cuts up to 45° to the left and 15° to the right**
Pemotongan serong sehingga 45° ke kiri dan 15° ke kanan
斜角向左切割45°，向右切割15°



Standard Equipment: Saw blade x6, Hex Wrench, Blade Change Rod



Continuous Rating Input Input Kuasa Berterusan 额定输入功率	50W
Capacity Kapasiti 能力	Thickness of cut : 50mm (2") Throat : 406mm (16")
Length of Stroke Panjang Strok 冲程长度	18mm (11/16")
Strokes Per Minute (SPM) Kelajuan Strok 冲程速度	400-1,600
Overall Length Panjang Keseluruhan 总长度	600mm (23-5/8")
Net Weight Berat Bersih 淨重	14kg (30.87lbs)

LB1200F

Band Saw Gergaji Band 带锯



- **High/ low speed selection for excellent results in both hard and soft wood**
Pemilihan kelajuan tinggi/ rendah untuk kayu keras dan lembut
高/低速选择，切割硬木和软木



Standard Equipment: Band Saw Blades, Rip Fence, Miter Gauge, Push Stick, Nozzle, Hex Wrench, Band Saw Stand



Continuous Rating Input Input Kuasa Berterusan 额定输入功率	900W
Capacity Kapasiti 能力	Thickness of cut : 165mm (6-1/2") Throat : 305mm (12")
Blade Speed Kelajuan Bilah 锯片速度	High: (50Hz)800 (60Hz)1,000m (50 Hz)2,624 (60 Hz) 3,280ft/ min Low: (50Hz)400 (60Hz)500m (50Hz)1,312 (60Hz) 1,640ft/ min
Dimensions (L x W x H) Dimensi 体积	615x775x1,600mm (24-1/4"x30-1/2"x63")
Net Weight Berat Bersih 淨重	82kg (181.2lbs)
Power Supply Cord Kabel Wayar 电源线	2.5m (8.2ft)

PLANING ROUTERING

Mengetam | Tanggam 刨削 | 雕刻



KP0810 82mm (3-1/4")

132

Power Planer

Planer Elektrik
电刨



- **Powerful & lightweight**
Berkuasa & ringan
强力与轻量

Standard Equipment: Blade Gauge, Depth Guide, Guide Rule,
Planer Blade, Socket Wrench



Continuous Rating Input Input Kuasa Berterusan 额定输入功率	850W
Planing Width Lebar Pelan 刨削宽度	82mm (3-1/4")
Planing Depth Kedalaman Pelan 刨削深度	4mm (5/32")
No Load Speed (RPM) Kelajuan Tanpa Beban 回转数	16,000
Dimensions (L x W x H) Dimensi 体积	290x168x176mm (11-3/8"x6-5/8"x6-15/16")
Net Weight Berat Bersih 净重	3.3kg (7.3lbs)
Power Supply Cord Kabel Wayar 电源线	2.5m (8.2ft)

KP0800X 82mm (3-1/4")

411

Power Planer

Planer Elektrik
电刨



- **High power & lightweight**
Kuasa tinggi & ringan
高功率与轻量

Standard Equipment: Planer Blade, Blade Gauge, Guide Rule,
Socket Wrench, Dust Nozzle



Continuous Rating Input Input Kuasa Berterusan 额定输入功率	620W
Planing Width Lebar Pelan 刨削宽度	82mm (3-1/4")
Planing Depth Kedalaman Pelan 刨削深度	2.5mm (3/32")
No Load Speed (RPM) Kelajuan Tanpa Beban 回转数	17,000
Dimensions (L x W x H) Dimensi 体积	285x158x158mm (11-1/4"x6-1/4"x6-1/4")
Net Weight Berat Bersih 净重	2.8kg (6.2lbs)
Power Supply Cord Kabel Wayar 电源线	2.5m (8.2ft)

N1900B 82mm (3-1/4")

51

Power Planer

Planer Elektrik
电刨



- **V-groove on base for easy chamfer cutting**
V-groove pada dasar untuk pemotongan melencong mudah
底座上的V型槽，便于倒角切割

Standard Equipment: Sharpening Holder Assembly,
Blade Gauge, Socket Wrench, Planer Blade, Guide Rule



Continuous Rating Input Input Kuasa Berterusan 额定输入功率	580W
Planing Width Lebar Pelan 刨削宽度	82mm (3-1/4")
Planing Depth Kedalaman Pelan 刨削深度	1mm (1/32")
No Load Speed (RPM) Kelajuan Tanpa Beban 回转数	16,000
Overall Length Panjang Keseluruhan 总长度	290mm (11-3/8")
Net Weight Berat Bersih 净重	2.8kg (6.1lbs)
Power Supply Cord Kabel Wayar 电源线	2.5m (8.2ft)

1911B 110mm (4-3/8")

106

Power Planer

Planer Elektrik
电刨



- **Powerful motor in compact and lightweight body**
Motor berkuasa badan padat dan ringan
马达功能强大，体积小重量轻

Standard Equipment: Sharpening Holder Assembly, Blade
Gauge, Socket Wrench, Planer Blade



Continuous Rating Input Input Kuasa Berterusan 额定输入功率	840W
Planing Width Lebar Pelan 刨削宽度	110mm (4-3/8")
Planing Depth Kedalaman Pelan 刨削深度	2mm (1/16")
No Load Speed (RPM) Kelajuan Tanpa Beban 回转数	16,000
Overall Length Panjang Keseluruhan 总长度	355mm (14")
Net Weight Berat Bersih 净重	4.1kg (9.1lbs)
Power Supply Cord Kabel Wayar 电源线	5.0m (16.4ft)

Cordless
Tanggam / 雕刻

LED Flashlight
Tanggam / 雕刻

Vacuum Cleaner
Tanggam / 雕刻

Drilling / Fastening
Gergaji / Tanggam / 雕刻

Impact Drilling / Demolition
Gergaji / Tanggam / 雕刻

Cutting
Tanggam / 雕刻

Grinding / Sanding
Tanggam / 雕刻

Sawing
Gergaji / 锯

Planing / Routing
Tanggam / 雕刻

Others
Tanggam / 雕刻

Outdoor Power Equipment
Tanggam / 雕刻

Makita
Tanggam / 雕刻

PLANING | ROUTERING

1805N 155mm (6-1/8")

153 W

Power Planer

Planer Elektrik
电刨



- **Rugged aluminum housing and easy depth settings**
Casing aluminium yang lasak dan penetapan kedalaman yang mudah
坚固的铝外壳和简单的深度设置

Standard Equipment: Sharpening Holder Assembly, Blade Gauge, Socket Wrench, Planer Blade



Continuous Rating Input Input Kuasa Berterusan 额定输入功率	1,140W
Planing Width Lebar Pelan 刨削宽度	155mm (6-1/8")
Planing Depth Kedalaman Pelan 刨削深度	2mm (1/16")
No Load Speed (RPM) Kelajuan Tanpa Beban 回转速数	15,000
Overall Length Panjang Keseluruhan 总长度	445mm (17-1/2")
Net Weight Berat Bersih 净重	7.9kg (17.3lbs)
Power Supply Cord Kabel Wayar 电源线	5.0m (16.4ft)

2012NB 304mm (12")

153 W

Planer

Planer Elektrik
电刨



- **Powerful 1,650W motor for improved performance**
Motor 1,650W yang berkuasa meningkatkan prestasi
功率强劲的1,650W马达提高了性能

Standard Equipment: Socket Wrench, Hex Wrench, Magnetic holder x2



Continuous Rating Input Input Kuasa Berterusan 额定输入功率	1,650W
Cutting Width Lebar Pelan 刨削宽度	304mm (12")
Cutting Depth Kedalaman Pelan 刨削深度	Cutting width 0-150mm: 3mm (1/8") Cutting width 150-240mm : 1.5mm (1/16")
Feed Rate (min) Kadar Suapan 进料速度	8.5m (27.9ft)
Table Size (W x L) Saiz Meja 工作台尺寸	304 x 771mm (12" x 30-3/8")
No Load Speed (RPM) Kelajuan Tanpa Beban 回转速数	8,500
Dimensions (L x W x H) Panjang Keseluruhan 总长度	483x771x401mm (19"x30-3/8"x15-13/16")
Net Weight Berat Bersih 净重	27.1 - 27.6kg (59.7 - 60.9lbs)
Power Supply Cord Kabel Wayar 电源线	2.5m (8.2ft)

3501N

153 W

Groove Cutter

Pemotong alur
沟锯



- **Powerful motor, easy depth adjustment**
Motor berkuasa, pelarasan kedalaman yang mudah
强大的马达，容易调整深度

Standard Equipment: Saw Blade (A-87507), Shipping Scale, Rip Fence (Guide Rule), Dressing Stone, Wrench x2, Screwdriver, Cutter Blade



Continuous Rating Input Input Kuasa Berterusan 额定输入功率	1,160W
Max Cutter Blade Size Saiz Bilah Maksimum 最大锯片尺寸	Dia. x Width: 120x36mm (4-3/4"x1-3/8")
Max Cutting Depth Kedalaman Pemotongan Maksimum 最大切割深度	Cutter/ Saw: 30mm (1-1/8")/ 65 mm (2-1/2")
No Load Speed (RPM) Kelajuan Tanpa Beban 回转速数	6,500
Overall Length Panjang Keseluruhan 总长度	365mm (14-3/8")
Net Weight Berat Bersih 净重	7.2kg (15.8lbs)
Power Supply Cord Kabel Wayar 电源线	5.0m (16.4ft)

PJ7000

459 W

Plate Joiner

Mesin Kerja Kayu
木工接合机

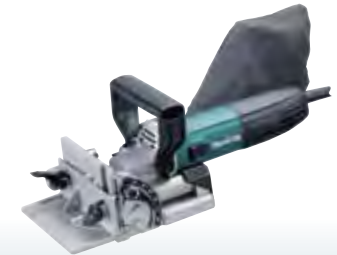

- **Large and easy-to-operate cam locks for fence adjustments**
Pelarasan pagar yang mudah
简易栅栏调节

Standard Equipment: Cutter Blade, Angle Guide, Dust Bag, Set Plate, Lock Nut Wrench



Continuous Rating Input Input Kuasa Berterusan 额定输入功率	701W
Blade Diameter Diameter Bilah 锯片直径	100mm (4")
No Load Speed (RPM) Kelajuan Tanpa Beban 回转速数	11,000
Dimensions (L x W x H) Dimensi 体积	302x139x145mm (11-7/8"x5-1/2"x5-3/4")
Net Weight Berat Bersih 净重	2.8kg (6.2lbs)
Power Supply Cord Kabel Wayar 电源线	2.5m (8.2ft)



PLANING | ROUTERING

3901

Plate Joiner

Mesin Kerja Kayu
木工接合机



- **Designed for making strong plate joints fast**
Direka untuk penyambungan rata
用于快速制作坚固的平板接头



Standard Equipment: Cutter Blade, Angle Guide, Dust Bag, Set Plate, Lock Nut Wrench



411

Continuous Rating Input Input Kuasa Berterusan 额定输入功率	590W
Blade Diameter Diameter Bilah 锯片直径	100mm (4")
Max Cutting Depth Kedalaman Pemotongan Maksimum 最大切割深度	20mm (3/4")
No Load Speed (RPM) Kelajuan Tanpa Beban 回转数	11,000
Overall Length Panjang Keseluruhan 总长度	307mm (12-1/16")
Net Weight Berat Bersih 净重	3.0kg (6.6lbs)
Power Supply Cord Kabel Wayar 电源线	2.5m (8.2ft)

RT0700C / X2 6mm (1/4"), 8mm (3/8")

Trimmer

Pemangkas
修边雕刻机



- **Powerful 710W motor for improved performance**
Motor berkuasa 710W untuk prestasi yang lebih baik
强大710W马达提高了性能



For RT0700X2 only



Standard Equipment:

RT0700C: Collet Cone, Trimmer Base Assembly, Straight Guide, Dust Nozzle, Wrench x2
RT0700X2: Collet Cone, Trimmer Base Assembly, Straight Guide, Dust Nozzle, Wrench x2, Side Grip, Templet Guide, Tilt Base Assembly, Plunge Base Assembly, Tool Bag



411

Continuous Rating Input Input Kuasa Berterusan 额定输入功率	710W
Collet Capacity Kapasiti Collet 夹头直径	6mm, 8mm or 1/4", 3/8"
No Load Speed (RPM) Kelajuan Tanpa Beban 回转数	10,000 - 30,000
Dimensions (L x W x H) Dimensi 体积	89x89x200mm (3-1/2"x3-1/2"x7-7/8")
Net Weight Berat Bersih 净重	1.8 - 2.7kg (3.9 - 6.0lbs)
Power Supply Cord Kabel Wayar 电源线	2.5m (8.2ft)

3709 6mm (1/4")

Trimmer

Pemangkas
修边雕刻机

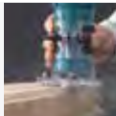

- **530W motor for smooth trimming**
530W motor untuk pemangkasan yang licin
530W马达提供平滑的修剪



Standard Equipment: Collet Cone, Trimmer Guide, Straight Guide Assembly, Templet Guide, Straight Bit, Chip Deflector, Wrench x2



411

Continuous Rating Input Input Kuasa Berterusan 额定输入功率	530W
Collet Capacity Kapasiti Collet 夹头直径	6mm or 1/4"
No Load Speed (RPM) Kelajuan Tanpa Beban 回转数	30,000
Dimensions (L x W x H) Dimensi 体积	82x90x199mm (3-1/4"x3-1/2"x7-7/8")
Net Weight Berat Bersih 净重	1.5kg (3.3lbs)
Power Supply Cord Kabel Wayar 电源线	2.5m (8.2ft)

RP0900 6mm (1/4"), 8mm (3/8")

Router (Plunge type)

Pemangkas
雕刻机



- **Oversized ball bearing construction for longer tool life**
Konstruksi gelas bebola untuk memanjangkan hayat alat
超大滚珠轴承结构, 延长工具寿命



Standard Equipment: Straight Guide, Straight Bit, Collet cone x2, Wrenches



106

Continuous Rating Input Input Kuasa Berterusan 额定输入功率	900W
Collet Capacity Kapasiti Collet 夹头直径	6mm, 8mm or 1/4", 3/8"
Plunge Capacity Kapasiti Plunge 能力	0 - 35mm (0 - 1-3/8")
No Load Speed (RPM) Kelajuan Tanpa Beban 回转数	27,000
Dimensions (L x W x H) Dimensi 体积	110x256x217mm (4-5/16"x10-3/32"x8-17/32")
Net Weight Berat Bersih 净重	2.7kg (6lbs)
Power Supply Cord Kabel Wayar 电源线	2.5m (8.2ft)

RP2301FC 12mm (1/2")

Router (Plunge type)

Pemangkas
雕刻机



- **Powerful 2,100W motor for the most demanding applications**
Motor 2,100W berkuasa untuk aplikasi yang paling mencabar
功能强大2,100W马达, 适用于要求苛刻的应用



Standard Equipment: Straight Guide, Collet Cone, Wrench, Screw M6x135, Straight Bit 1/2" (D-07901)

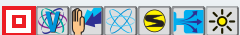

203

Continuous Rating Input Input Kuasa Berterusan 额定输入功率	2,100W
Collet Capacity Kapasiti Collet 夹头直径	12mm or 1/2"
Plunge Capacity Kapasiti Plunge 能力	0 - 70mm (0 - 2-3/4")
No Load Speed (RPM) Kelajuan Tanpa Beban 回转数	9,000 - 22,000
Dimensions (L x W x H) Dimensi 体积	155x294x312mm (6-1/8"x11-5/8"x12-1/4")
Net Weight Berat Bersih 净重	6.1kg (13.5lbs)
Power Supply Cord Kabel Wayar 电源线	4.0m (13.1ft)

Cordless
Tangan Kiri / Right

LED Flashlight
Tangan Kiri / Right
LED Flashlight

Vacuum Cleaner
Tangan Kiri / Right
Vacuum Cleaner

Drilling / Fastening
Cairan / Tenggol
Drilling / Fastening

Impact Drilling / Demolition
Dauar / Pemukul
Impact Drilling / Demolition

Cutting / Fastening
Pemotong / Tenggol
Cutting / Fastening

Grinding / Sanding
Tenggol / Pasir
Grinding / Sanding

Sawing
Dauar
Sawing

Planing / Routing
Papan / Tenggol
Planing / Routing

Others
Lain-lain
Others

Outdoor Power Equipment
Alatan Papan Luar
Outdoor Power Equipment

Makita
Tangan Kiri / Right

PLANING | ROUTERING

RP1801 12mm (1/2")

203

Router (Plunge type)

Pemangkas
雕刻机



- **Electric brake for increased operator safety**
Brake elektrik untuk pengguna keselamatan
电子自动刹车

Standard Equipment: Straight Guide, Collet Cone, Wrench,
Screw M6x135, Template Guide



Continuous Rating Input Input Kuasa Berterusan 额定输入功率	1,650W
Collet Capacity Kapasiti Collet 夹头直径	12mm or 1/2"
Plunge Capacity Kapasiti Plunge 能力	0 - 70mm (0 - 2-3/4")
Base Dia. Diameter Pangkalan 底座直径	170mm (6-11/16")
No Load Speed (RPM) Kelajuan Tanpa Beban 回转数	22,000
Dimensions (L x W x H) Dimensi 体积	155x294x312mm (6-1/8"x11-5/8"x12-1/4")
Net Weight Berat Bersih 净重	6kg (13.2lbs)
Power Supply Cord Kabel Wayar 电源线	4.0m (13.1ft.)

3612BR 12mm (1/2")

153

Router (Plunge type)

Pemangkas
雕刻机



- **Conveniently located plunge lock lever for efficient operation**
Pelarasan tuil yang mudah untuk operasi yang cekap
便利的插入式锁定杆可实现高效操作

Standard Equipment: Straight Guide, Templet Guide, Trimmer Guide,
Guide Holder, Collet Sleeve (6mm or 1/4"), Collet Sleeve (8mm or 3/8"),
Straight Bit (Carbide-Tipped) D-07901, Wrench



Continuous Rating Input Input Kuasa Berterusan 额定输入功率	1,600W
Collet Capacity Kapasiti Collet 夹头直径	12mm or 1/2"
Plunge Capacity Kapasiti Plunge 能力	0 - 65mm (0 - 2-9/16")
No Load Speed (RPM) Kelajuan Tanpa Beban 回转数	23,000
Dimensions (L x W x H) Dimensi 体积	160x276x287mm (6-5/16"x10-7/8"x11-5/16")
Net Weight Berat Bersih 净重	5.5kg (12.1lbs)
Power Supply Cord Kabel Wayar 电源线	2.5m (8.2ft.)



3600H 12mm (1/2")

153

Router

Pemangkas
雕刻机

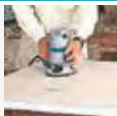

- **D-handle design with locking trigger switch for comfort during continuous operation**
Pemegang-D dengan suis pencetus berkunci untuk keselesaan
semasa operasi berterusan
带锁定扳机开关的D型手柄设计可确保连续操作时的舒适性

Standard Equipment: Trimmer Guide, Straight Guide Assembly,
Templet Guide, Collet Sleeve (6mm or 1/4"), Collet Sleeve (8mm or 3/8"),
Wrench, Straight Bit (Carbide-Tipped) D-07901

Continuous Rating Input Input Kuasa Berterusan 额定输入功率	1,500W
Collet Capacity Kapasiti Collet 夹头直径	12mm or 1/2"
Base Dia. Diameter Pangkalan 底座直径	160mm (6-1/4")
No Load Speed (RPM) Kelajuan Tanpa Beban 回转数	24,000
Overall Height Panjang Keseluruhan 总长度	210mm (8-1/4")
Net Weight Berat Bersih 净重	4.4kg (9.8lbs)
Power Supply Cord Kabel Wayar 电源线	5.0m (16.4ft)

4403 6mm (1/4")

411

Sash Router

Pemangkas Sash
窗扇雕刻机

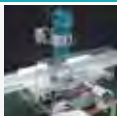

- **Large transparent chip guard for operator's safety**
Pengawal cip telus yang besar untuk keselamatan pengguna
大型透明芯片防护罩保证操作者的安全

Standard Equipment: Collet cone (6mm or 1/4"),
Drill Point Sash Router Bit (D-16972), Angle Gauge,
Wrench x2, Oil supply



Continuous rating input Input Kuasa Berterusan 额定输入功率	530W
Capacity Kapasiti 能力	Collet: 6mm or 1/4"
Max Width of Work Lebar Kerja Maksimum 最大工作宽度	123mm (4-7/8")
Max Width of Work (45°) Lebar Kerja Maksimum 最大工作宽度	77mm (3")
Max Height of Work Ketinggian Kerja Maksimum 最大工作高度	185mm (7-1/4")
No Load Speed (RPM) Kelajuan Tanpa Beban 回转数	30,000
Dimensions (L x W x H) Dimensi 体积	327x350x355mm (12-7/8"x13-13/16"x14")
Net Weight Berat Bersih 净重	16kg (35.3lbs)
Power Supply Cord Kabel Wayar 电源线	2.5m (8.2ft)

OTHERS

Lain-lain 其他



AF506

Pneumatic Brad Nailer

Penembak Paku Brad Pneumatik
气钉枪



- **Lightweight for reduced operator fatigue**
Ringan untuk mengurangi kelelahan pengguna
轻量不易引起疲劳

Standard Equipment: Safety Goggles, Nose Adapter, Oil



Capacity Kapasiti 能力	Length: 15 - 50mm (5/8" - 2")		
Operating Pressure Tekanan Beroperasi 使用气压	Gauge: 18Ga 0.49 - 0.83MPa (70 - 120PSI)		
Magazine Capacity Bilangan Staples 装订个数	100		
Compressed Air Udara Mampat 压缩空气	Driver stroke: 85.5mm (3-3/8") Cylinder bore diameter: 28mm (1-1/8")		
Dimensions (L x W x H) Dimensi 体积	250x70x256mm (9-7/8"x2-3/4"x10-1/8")		
Net Weight Berat Bersih 净重	1.3kg (2.9lbs.)		
Accessories (optional)			
Description	Size	Pcs/ Box	Part No.
Brad Nail 15mm (5/8")	F15	5,000	B-04307
Brad Nail 20mm (3/4")	F20	5,000	B-04313
Brad Nail 25mm (1")	F25	5,000	B-04329
Brad Nail 30mm (1-3/16")	F30	5,000	B-04335
Brad Nail 35mm (1-3/8")	F35	5,000	B-04357

AF353

Pneumatic Pin Nailer

Mesin Pemaku Pneumatik
气钉枪



- **Lightweight for reduced operator fatigue**
Ringan untuk mengurangi kelelahan pengguna
轻量不易引起疲劳

Standard Equipment: Safety Goggles, Nose Adapter, Hex Wrench, Oil



Capacity Kapasiti 能力	Length: 15 - 35mm (5/8" - 1-3/8")		
Operating Pressure Tekanan Beroperasi 使用气压	Gauge: 23Ga 0.45 - 0.69MPa (65 - 100PSI)		
Magazine Capacity Bilangan Staples 装订个数	130		
Dimensions (L x W x H) Dimensi 体积	208x66x191mm (8-3/16"x2-5/8"x7-1/2")		
Net Weight Berat Bersih 净重	0.9kg (2lbs.)		
Accessories (optional)			
Description	Size	Pcs/ Box	Part No.
Brad Nail 15mm (5/8")	F15	5,000	B-04307
Brad Nail 20mm (3/4")	F20	5,000	B-04313
Brad Nail 25mm (1")	F25	5,000	B-04329
Brad Nail 30mm (1-3/16")	F30	5,000	B-04335
Brad Nail 35mm (1-3/8")	F35	5,000	B-04357

AF601

Pneumatic Finish Nailer

Mesin Pemaku Pneumatik
气钉枪



- **Lightweight for reduced operator fatigue**
Ringan untuk mengurangi kelelahan pengguna
轻量不易引起疲劳

Standard Equipment: Safety Goggles, Nose Adapter, Oil



Capacity Kapasiti 能力	Length: 25 - 64mm (1" - 2-1/2")		
Operating Pressure Tekanan Beroperasi 使用气压	Gauge: 16Ga 0.49 - 0.83MPa (70 - 120PSI)		
Magazine Capacity Bilangan Staples 装订个数	100		
Dimensions (L x W x H) Dimensi 体积	304x95x297mm (12"x3-3/4"x11-3/4")		
Net Weight Berat Bersih 净重	1.7kg (3.8lbs.)		
Accessories (optional)			
Description	Size	Pcs/ Box	Part No.
Brad Nail 25mm (1")	F25	5,000	B-04329
Brad Nail 30mm (1-3/16")	F30	5,000	B-04335
Brad Nail 35mm (1-3/8")	F35	5,000	B-04357

AF635

Pneumatic Finish Nailer

Mesin Pemaku Pneumatik
气钉枪



- **Lightweight for reduced operator fatigue**
Ringan untuk mengurangi kelelahan pengguna
轻量不易引起疲劳

Standard Equipment: Safety Goggles, Nose Adapter, Oil



Capacity Kapasiti 能力	Length: 32 - 64mm (1-1/4" - 2-1/2")		
Operating Pressure Tekanan Beroperasi 使用气压	Gauge: 15Ga 0.49 - 0.83MPa (70 - 120PSI)		
Magazine Capacity Bilangan Staples 装订个数	100		
Dimensions (L x W x H) Dimensi 体积	339x100x309mm (13-3/8"x3-15/16"x12-1/8")		
Net Weight Berat Bersih 净重	1.8kg (4lbs.)		
Accessories (optional)			
Description	Size	Pcs/ Box	Part No.
Brad Nail 35mm (1-3/8")	F35	5,000	B-04357

Cordless
Terdapat Model Tanpa Kabel

LED Flashlight
Lampu Senter LED
- LED BRIGHT

Vacuum Cleaner
Penyedot Debu
- BLUETOOTH

Drilling / Fastening
Tukang / Pengikat
- BATERAI

Impact Drilling / Demolition
Gergaji / Pemecah
- BATERAI

Cutting / Finishing
Pemotong / Finishing
- BATERAI

Grinding / Sanding
Gergaji / Finishing
- BATERAI

Sawing
Gergaji
- BATERAI

Planing / Routing
Penghalus / Ratakan
- BATERAI

Others
Lain-lain

Outdoor Power Equipment
Alat-alat Tenaga Luar
- BATERAI



OTHERS

AT638A

Narrow Crown Stapler Mesin Pemaku Pneumatik 气钉枪



- **Lightweight for reduced operator fatigue**
Ringan untuk mengurangi kelelahan pengguna
轻量不易引起疲劳

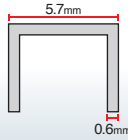

Standard Equipment:
Safety Goggles, Nose Adapter, Oil



Capacity Kapasiti 能力	Length: 13 - 38mm (1/2" - 1-1/2") Gauge: 15Ga Width: 5.7mm
Operating Pressure Tekanan Beroperasi 使用气压	0.49 - 0.83MPa (70 - 120PSI)
Magazine Capacity Bilangan Staples 装订个数	100
Dimensions (L x W x H) Dimensi 体积	230x75x251mm (9"x2-15/16"x9-7/8")
Net Weight Berat Bersih 净重	1.2kg (2.7lbs.)



Heat Gun

Accessories (Optional)

Pistol Udara Panas 热风枪

Shape	Part No.
Glass protection nozzle	PR0000028
Wide-slot nozzle	PR0000029
Reflector nozzle	PR0000030
Reduction nozzle 20	PR0000031
Overlap welding nozzle	PR0000032
Solder sleeves reflector	PR0000033

Shape	Part No.
Welding nozzle	PR0000034
Pressure roller	PR0000035
Welding rods	ABS PR0000036
	HDPE PR0000037
	PP PR0000038
Speed welding nozzle	PR0000039
Scraper	PR0000040
Scraper set	PR0000041
Scraper	PR0000042

HG6530VK

Heat Gun Pistol Udara Panas 热风枪

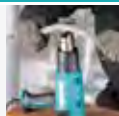

- **3-speed blower settings for greater versatility**
Kawalan kelajuan 3 tahap untuk pelbagai aplikasi
3速度控制适合多种用途

Standard Equipment: Glass Protection Nozzle, Reflector Nozzle, Reduction Nozzle, Wide Slot Nozzle



Air Temperature (°C) Suhu Udara 气温	50 - 650
Air Flow Aliran Udara 空气流量	Stage 1: 500 L/min Stage 2: 280 L/min Stage 3: 550 L/min
Dimensions (L x W x H) Dimensi 体积	257x85x206mm (10-1/8"x3-3/8"x8-1/8")
Net Weight Berat Bersih 净重	0.72kg (1.6lbs.)
Power Supply Cord Kabel Wayar 电源线	2.0m (6.6ft)

Cordless
Tali Wayar Tanpa Tali

LED Flashlight
Lampu Sinar LED
1500MBATT

Vacuum Cleaner
Penyedut Vakuum
2.5/200W

Drilling / Fastening
Borak / Pasang
M10 / 1.8kW

Impact Drilling / Demolition
Borak / Perseki
6.5/3.5kW

Cutting / Removing
Potong / Hilang

Grinding / Smoothing
Giling / Halus

Sawing
Gajet

Planing / Routing
Ratakan / Ratakan

Others
Lain-lain

Outdoor Power Equipment
Alatan Yaitu Luar
0.8B-7.5kW

Makita
1915

OTHERS



HG6031VK

Heat Gun

Pistol Udara Panas
热风枪



- **9-temperature settings (50 - 600°C) for a variety of applications**

9 tetapan suhu (50 - 600°C) sesuai untuk pelbagai aplikasi
9个温度设定 (50 - 600°C) 适合于各种用途

Standard Equipment: Glass Protection Nozzle, Reflector Nozzle, Reduction Nozzle, Wide Slot Nozzle



Continuous Rating Input Input Kuasa Berterusan 额定输入功率	1,800W
Air Temperature (°C) / Flow (L/min) Suhu Udara 气温	Switch 1: 50 - 400 / 250 Switch 2: 100 - 600 / 500
Dimensions (L x W x H) Dimensi 体积	257x85x206mm (10-1/8"x3-3/8"x8-1/8")
Net Weight Berat Bersih 淨重	0.67kg (1.5lbs)
Power Supply Cord Kabel Wayar 电源线	2.0m (6.6ft)

HG5030K

Heat Gun

Pistol Udara Panas
热风枪

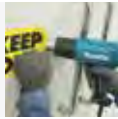

- **2 temperature settings (350 and 500°C)**

2 tetapan suhu (350 dan 500°C)
2个温度设定 (350和500°C)

Standard Equipment: Glass Protection Nozzle, Reflector Nozzle, Reduction Nozzle, Wide Slot Nozzle



Continuous Rating Input Input Kuasa Berterusan 额定输入功率	1,600W
Air Temperature (°C) / Flow (L/min) Suhu Udara 气温	Switch 1: 350 / 300 Switch 2: 500 / 500
Dimensions (L x W x H) Dimensi 体积	233x80x208mm (9-1/8"x3-1/8"x8-3/16")
Net Weight Berat Bersih 淨重	0.56kg (1.2lbs)
Power Supply Cord Kabel Wayar 电源线	2.0m (6.6ft)

SK104Z

Cross Line Laser

Laser Garis Salib
十字线激光

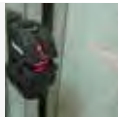

- **Accuracy +/- 3mm @ 10m**

Ketepatan +/- 3mm @ 10m
精确度 +/- 3mm @ 10m

Standard Equipment: Wall Mount Bracket, Target Plate, AA Battery, Pouch with strap

Measuring Range Jarak Mengukur 测量范围	Up to: 15m w/ detector up to: 60m
Leveling Accuracy Menunjukkan Ketepatan 指示精确度	±3mm/ 10m
Self-leveling Range Julat Indikasi Menegak 垂直指示范围	4+1°
Laser Fan Angle Sudut Peminat Laser 激光扇角	Horizontal: 180° Vertical: 180°
Number of Laser Bilangan Garisan Laser 激光线数量	points: 4 lines: 2
Laser Type Jenis Laser 激光类型	Laser class 2: 635nm
Tripod Thread Tripod 脚架	1/4"
Protection Class Tahap Perlindungan 保护等级	IP54
Net Weight Berat Bersih 淨重	0.53kg (1.17lbs)

LD030P

Laser Distance Measure

Langkah Jarak Laser
激光测距



- **Measuring distance operating range up to 30m**

Mengukur jarak operasi jarak sehingga 30m
测量距离可达30米

Measuring Range Jarak Mengukur 测量范围	0.2-30m
Typical Measuring Tolerance Toleransi Mengukur Biasa 典型的测量公差	±2.0mm/ 10m
Max Measuring Tolerance Toleransi Mengukur Maksimum 最大测量公差	±3.0mm/ 10m
Diameter of Laser Point Diameter Titik Laser 激光点的直径	6mm/ 10m
Laser Type Jenis Laser 激光类型	Laser class 2: 635nm
Dimensions (H x D x W) Dimensi 体积	117x53x25mm (4.5"x2.14"x1")
Net Weight Berat Bersih 淨重	0.1kg (0.22lbs)

Cordless
Terdapat Model Tanpa Kabel

LED Flashlight
Lampu Sulu LED
LED LIGHT

Vacuum Cleaner
Penyedut Hava
VACUUM

Drilling / Fastening
Tukul / Pengikat
DRILL / FASTEN

Impact Drilling / Demolition
Gergaji / Penebuk
IMPACT DRILL / DEMOLITION

Cutting
Pemotong
CUTTING

Grinding / Sanding
Mogok / Gores
GRINDING / SANDING

Sawing
Gergaji
SAWING

Planing / Routing
Mogok / Mengukir
PLANING / ROUTING

Others
Lain-lain
OTHERS

Outdoor Power Equipment
Alatan Kuasa Luar
OUTDOOR POWER EQUIPMENT

Makita
MAKITA

OTHERS

Cordless
Tahan Bantut
LED Flashlight
Lampu Senter LED
Vacuum Cleaner
Penyedot Vakum
Drilling / Fastening
Bor / Pasang
Impact Drilling / Demolition
Bor / Pasang / Demolis
Cutting / Finishing
Potong / Finis
Grinding / Sanding
Giling / Pasang
Sawing
Gigit
Planing / Routing
Pengaliran / Rongkah
Others
Lain-lain
Outdoor Power Equipment
Alat Daya Luar
Makita
1911

LD050P

Laser Distance Measure

Langkah Jarak Laser
激光测距



- **Measuring distance operating range up to 50m**
Mengukur jarak operasi jarak sehingga 50m
测量距离可达50米

Standard Equipment: Pouch

Measuring Range Jarak mengukur 测量范围	0.05-50m
Power Supply Bekalan Kuasa 电源	Cell battery : AAA 1.5V x 2pcs
Net Weight Berat Bersih 淨重	0.1kg (0.22lbs)

LD080P / PI

Laser Distance Measure

Langkah Jarak Laser
激光测距



- **Measuring distance operating range up to 80m**
Mengukur jarak operasi jarak sehingga 80m
测量距离可达80米

Standard Equipment: Carrying Strap, Pouch

Measuring Range Jarak mengukur 测量范围	0.05-80m
Power Supply Bekalan Kuasa 电源	Cell battery : AAA 1.5V x 2pcs
Net Weight Berat Bersih 淨重	0.14kg (0.31lbs)

UB1103

303 W

Blower

Mesin Blower
吹风机



- **Two tools in one; quickly converts to a vacuum for added versatility**
Alat 2 dalam 1, vakum dan blower untuk fleksibiliti tambahan
一机2用, 集尘与吹风

Standard Equipment: Nozzle, Dust Bag



Continuous Rating Input Input Kuasa Berterusan 额定输入功率	600W
Max Air Volume Isipadu Angin Maksimum 最大风量	0 - 4.1m³/min
Max Air Velocity Velositi Angin Maksimum 最大风速	0 - 91m/s
Air Pressure Tekanan Udara 气压	0 - 5.7kPa
No Load Speed (RPM) Kelajuan Tanpa Beban 回转数	0 - 16,000
Dimensions (L x W x H) Dimensi 体积	479x185x178mm (18-7/8"x7-1/4"x7")
Net Weight Berat Bersih 淨重	1.9 - 2.2kg (4.3 - 4.8lbs)
Power Supply Cord Kabel Wayar 电源线	2.5m (8.2ft.)

HS100

Hammer Tacker

Alat Manual Memaku Mesin
手动工具敲钉机



Capacity Kapasiti 能力	Width: 12mm Length: 6 - 10mm
Magazine Capacity Bilangan Staples 装订个数	144
Dimensions (L x W x H) Dimensi 体积	281mm
Net Weight Berat Bersih 淨重	0.5kg



OUTDOOR POWER EQUIPMENT



UC3551A 350mm (14") | UC4051A 400mm (16")

153

Electric Chain Saw Gergaji Rantai 电链锯



- **Fast and efficient cutting**
Pemotongan cepat dan cekap
快速高效的切割

Standard Equipment: Saw Chain, Guide Bar, Guide Bar Cover,
Hook Complete



Continuous Rating Input Input Kuasa Berterusan 额定输入功率	1,800W
Chain Speed per Minute Kelajuan Rantai 链条速度	870m (2,900ft)
Guide Bar Length Panjang Bar Panduan 导板长度	350mm (14") UC3551A 400mm (16") UC4051A
Saw Chain Rantai 链条	Pitch : 9.5mm (3/8") Gauge: 1.3mm (0.050")
Dimensions (L x W x H) Dimensi 体积	505x200x220mm (19-7/8"x7-7/8"x8-5/8")
Net Weight Berat Bersih 净重	5.5kg (12.1lbs) UC3551A 5.6kg (12.3lbs) UC4051A
Power Supply Cord Kabel Wayar 电源线	0.3m (0.98ft)

UC3541A 350mm (14") | UC4041A 400mm (16")

132

Electric Chain Saw Gergaji Rantai 电链锯



- **Zero emissions and reduced maintenance**
Tanpa perlepasan asap & penyelenggaraan rendah
无排气及降低保养少维护

Standard Equipment: Saw Chain, Guide Bar, Guide Bar Cover,
Hook Complete



Continuous Rating Input Input Kuasa Berterusan 额定输入功率	1,800W
Chain Speed per Minute Kelajuan Rantai 链条速度	870m (2,900ft)
Guide Bar Length Panjang Bar Panduan 导板长度	350mm (14") UC3541A 400mm (16") UC4041A
Saw Chain Rantai 链条	Pitch : 9.5mm (3/8") Gauge: 1.1mm (0.043")/ 1.3mm (0.050")
Dimensions (L x W x H) Dimensi 体积	455x245x200mm (17-7/8"x9-5/8"x7-7/8")
Net Weight Berat Bersih 净重	4.7 - 4.9kg (10.4 - 10.6lbs)
Power Supply Cord Kabel Wayar 电源线	0.3m (0.98ft)

5016B 405mm (16")

153

Electric Chain Saw Gergaji Rantai 电链锯



- **Compact and lightweight design**
Reka bentuk padat dan ringan
小巧轻便的设计

Standard Equipment: Saw Chain, Oil supply 100ml,
Socket Wrench, File, Screwdriver



Continuous Rating Input Input Kuasa Berterusan 额定输入功率	1,300W
Chain Speed per Minute Kelajuan Rantai 链条速度	400m (1,310ft)
Guide Bar Length Panjang Bar Panduan 导板长度	405mm (16")
Saw Chain Rantai 链条	Pitch : 9.5mm (3/8") Gauge: 1.3" or 0.050"
Overall Length Panjang Keseluruhan 总长度	750mm (29-1/2")
Net Weight Berat Bersih 净重	5.8kg (12.7lbs)
Power Supply Cord Kabel Wayar 电源线	5.0m (16.4ft)

Cordless
Tidak Perlu BekalLED Flashlight
Lampu Bercahaya LED
15000000Vacuum Cleaner
Penyedut Debu
2.5LDrilling / Fastening
Draib / Pasang
1/4" x 1/8"Impact Drilling / Demolition
Draib / Hancurkan
1/4" x 1/8"Cutting
MemotongGrinding / Sanding
Menggosok / Mengkilap
1/4" x 1/8"Sawing
MemotongPlaning / Routing
Mengkilap / Mengkilap
1/4" x 1/8"Others
Lain-lain
1/4" x 1/8"Outdoor Power Equipment
Alat Kuasa Luar
1/4" x 1/8"Makita
1915

OUTDOOR POWER EQUIPMENT

EA3201S40B 400mm (16")

Petrol Chain Saw

Gergaji Rantai Petrol
汽油链锯



CATALYTIC
CONVERTER



Sementara stok masih ada
WHILE STOCK LAST
可購數量有限

- **Touch & stop switch system keeps spark plug from getting wet**
Sistem suis mengelakkan palam cucuh daripada menjadi basah
可防止火花塞受潮的开关系统

Standard Equipment: Guide Bar, Saw Chain, Guide Bar Cover, Steel spike bumper, Socket Wrench, Screwdriver



Saw Chain Rantai 链条	Pitch : 9.5mm (3/8") Gauge: 1.1mm (0.043") or 1.3mm (0.050")
Displacement Sesaran 排量	32mL
Engine Power Kuasa Enjin 发动机功率	1.35kW/ 1.9PS
Fuel Tank Capacity Tangki Minyak 油箱容量	0.4L (13.5US oz)
Chain Oil Tank Volume Tangki Minyak Pelincir 链油箱	0.28L (9.5US oz)
Dimensions (L x W x H) Dimensi 体积	405x269x273mm (16"x10-5/8"x10-3/4")
Power Head Weight Berat Kepala Kuasa 动力头重量	4.2kg (9.3lbs.)

EA4301F45B 450mm (18")

Petrol Chain Saw

Gergaji Rantai Petrol
汽油链锯



Sementara stok masih ada
WHILE STOCK LAST
可購數量有限

- **Increased output power**
Peningkatan kuasa output
增加输出功率

Standard Equipment: Saw Chain, Guide Bar, Guide Bar Cover, Socket Wrench, Hex Wrench, Screwdriver



Saw Chain Rantai 链条	Pitch : 0.325" or 3/8" Gauge: 1.3mm (0.050")
Displacement Sesaran 排量	42.4mL
Engine Power Kuasa Enjin 发动机功率	2.2kW/ 3.0PS
Fuel Tank Capacity Tangki Minyak 油箱容量	0.48L
Chain Oil Tank Volume Tangki Minyak Pelincir 链油箱	0.28L
Dimensions (L x W x H) Dimensi 体积	416x248x279mm (16-3/8"x9-3/4"x11")
Power Head Weight Berat Kepala Kuasa 动力头重量	4.8kg (10.5lbs.)

EA6100P 530mm (21")

Petrol Chain Saw

Gergaji Rantai Petrol
汽油链锯



STRATIFIED
SCAVENGING



- **Up to 20% less fuel consumption and lower emissions**
Kurang penggunaan bahan api sehingga 20% dan pelepasan asap yang lebih rendah
燃料消耗降低20%，排放气降低

Standard Equipment: Saw Chain, Guide Bar Cover, Wrenches



Saw Chain Rantai 链条	Pitch : 9.5mm (3/8") Gauge: 1.5mm (0.058")
Displacement Sesaran 排量	60.7mL
Engine Power Kuasa Enjin 发动机功率	3.4kW/ 4.6PS
Fuel Tank Capacity Tangki Minyak 油箱容量	0.8L (27.1US oz)
Chain Oil Tank Volume Tangki Minyak Pelincir 链油箱	0.48L (16.2US oz)
Dimensions (L x W x H) Dimensi 体积	435x243x312mm (17-1/8"x9-9/16"x12-1/4")
Power Head Weight Berat Kepala Kuasa 动力头重量	6.0kg (13.2lbs.)

EA7900P70E 600mm (24")

Petrol Chain Saw

Gergaji Rantai Petrol
汽油链锯



SCAVENGING
LOSSES REJECTION



- **Adjustable automatic chain lubrication with large oil reservoir**
Pelarasan pelinciran rantai automatik dengan takungan minyak yang besar
可调自动链条润滑

Standard Equipment: Saw Chain, Guide Bar, Guide Bar Cover, Socket Wrench



Saw Chain Rantai 链条	Pitch : 9.5mm (3/8") Gauge: 1.5mm (0.058")
Displacement Sesaran 排量	79mL
Engine Power Kuasa Enjin 发动机功率	4.3kW/ 5.8PS
Fuel Tank Capacity Tangki Minyak 油箱容量	0.75L (25.4US oz)
Chain Oil Tank Volume Tangki Minyak Pelincir 链油箱	0.42L (14.2US oz)
Power Head Weight Berat Kepala Kuasa 动力头重量	6.3kg (13.8lbs.)

DCS520-53 530mm (21")

Petrol Chain Saw

Gergaji Rantai Petrol
汽油链锯



- **Automatic adjustable chain oiler**
Pelarasan minyak rantai automatik
自动调节链条油

Standard Equipment: Saw Chain, Guide Bar Cover, Wrenches



Saw Chain Rantai 链条	Pitch : 9.5mm (3/8") Gauge: 1.5mm (0.058")
Displacement Sesaran 排量	52mL
Power Rating Kuasa Enjin 发动机功率	2.4kW
Fuel Tank Capacity Tangki Minyak 油箱容量	0.56L
Chain Oil Tank Volume Tangki Minyak Pelincir 链油箱	0.28L
Power Head Weight Berat Kepala Kuasa 动力头重量	4.5kg (9.9lbs.)

Cordless
Taliway Kordless

LED Flashlight
Lampu Suis LED
LUMINA

Vacuum Cleaner
Penyedut Debu
VACUUM

Drilling / Flapening
Gergaji / Penghalus
DRILL / FLAPENING

Impact Drilling / Demolition
Gergaji / Patahkan
IMPACT DRILL / DEMOLITION

Cutting
Pemotong
CUTTING

Grinding / Sanding
Halus / Pasir
GRINDING / SANDING

Sawing
Gergaji
SAWING

Planing / Routing
Halus / Rutekan
PLANING / ROUTING

Others
Lain-lain
OTHERS

Outdoor Power Equipment
Alatan Elektrik Luar
OUTDOOR POWER EQUIPMENT

Makita
Makita

OUTDOOR POWER EQUIPMENT

DCS6401-50 500mm (20")

Petrol Chain Saw

Gergaji Rantai Petrol
汽油链锯



- **Vibration damping with tough, long-life steel springs**

Getaran redaman dengan pegas keluli yang tahan lama
减震, 坚韧, 而耐久的 钢弹簧

Standard Equipment: Saw Chain, Guide Bar Cover, Wrenches



Saw Chain Rantai 链条	Pitch : 9.5mm (3/8") Gauge: 1.5mm (0.058")
Displacement Sesaran 排量	64mL
Engine Power Kuasa Enjin 发动机功率	3.5kW/ 4.8PS
Fuel Tank Capacity Tangki Minyak 油箱容量	0.75L
Chain Oil Tank Volume Tangki Minyak Pelincir 链油箱	0.42L
Power Head Weight Berat Kepala Kuasa 动力头重量	6.3kg (13.89lbs.)

DCS7301-60 600mm (24")

Petrol Chain Saw

Gergaji Rantai Petrol
汽油链锯



- **Improved air filtration through the Air master air filter system**

Penapis udara yang lebih baik
改进的空气过滤系统改善空气过滤

Standard Equipment: Saw Chain, Guide Bar Cover, Wrenches



Saw Chain Rantai 链条	Pitch : 3/8" Gauge: 1.5mm (0.058")
Displacement Sesaran 排量	72.6mL
Engine Power Kuasa Enjin 发动机功率	4.2kW/ 5.7PS
Fuel Tank Capacity Tangki Minyak 油箱容量	0.75L
Chain Oil Tank Volume Tangki Minyak Pelincir 链油箱	0.42L
Power Head Weight Berat Kepala Kuasa 动力头重量	6.3kg (13.89lbs.)

SEMENTRA SOKOK HANGAT
WHILE STOCK LAST
平頭 貨 盡

DCS7901-70 700mm (28")

Petrol Chain Saw

Gergaji Rantai Petrol
汽油链锯



- **Improved air filtration through the Air master air filter system**

Penapis udara yang lebih baik
改进的空气过滤系统改善空气过滤

Standard Equipment: Saw Chain, Guide Bar Cover, Wrenches



Saw Chain Rantai 链条	Pitch : 9.5mm (3/8") Gauge: 1.5mm (0.058")
Displacement Sesaran 排量	78.5mL
Engine Power Kuasa Enjin 发动机功率	4.6kW/ 6.3PS
Fuel Tank Capacity Tangki Minyak 油箱容量	0.75L
Chain Oil Tank Volume Tangki Minyak Pelincir 链油箱	0.42L
Power Head Weight Berat Kepala Kuasa 动力头重量	6.3kg (13.89lbs.)

DCS9010-76 740mm (29")

Petrol Chain Saw

Gergaji Rantai Petrol
汽油链锯



- **Heavy timber saw for the hardest working for professionals**

Gergaji kayu berat untuk profesional
适合专业人员的重型木锯

Standard Equipment: Saw Chain, Guide Bar Cover, Wrench, Screwdriver



Saw Chain Rantai 链条	Pitch : 9.5mm (3/8") Gauge: 1.5mm (0.058")
Displacement Sesaran 排量	90mL
Engine Power Kuasa Enjin 发动机功率	4.9kW/ 6.7PS
Fuel Tank Capacity Tangki Minyak 油箱容量	1L
Chain Oil Tank Volume Tangki Minyak Pelincir 链油箱	0.4L
Power Head Weight Berat Kepala Kuasa 动力头重量	8.2kg (18.1lbs.)

EA3110T30B 300mm (12")

Petrol Chain Saw

Gergaji Rantai Petrol
汽油链锯



- **Compact and lightweight body for better handling**

Padat dan ringan
小巧轻便的机身易于操纵

Standard Equipment: Guide Bar, Saw Chain, Guide Bar Cover, Socket Wrench, Screwdriver



Saw Chain Rantai 链条	Pitch : 9.5mm (3/8") Gauge: 1.3mm (0.050")
Displacement Sesaran 排量	30.1mL
Engine Power Kuasa Enjin 发动机功率	1.0kW/ 1.4PS
Fuel Tank Capacity Tangki Minyak 油箱容量	0.24L (8.1US oz)
Chain Oil Tank Volume Tangki Minyak Pelincir 链油箱	0.18L (6.1US oz)
Dimensions (L x W x H) Dimensi 体积	259x236x217mm (10-1/4"x9-1/4"x8-1/2")
Power Head Weight Berat Kepala Kuasa 动力头重量	3.2kg (7.0lbs.)

OUTDOOR POWER EQUIPMENT

UH7580X 750mm (29-1/2")

419

Electric Hedge Trimmer

Pemangkas Tanaman Pagar
电篱笆修剪机



- **Powerful 670W motor**
Motor berkuasa 670W
强劲的670W电机

Standard Equipment: Blade Cover, Hook complete, Belt Hook



Continuous Rating Input Input Kuasa Berterusan 额定输入功率	670W
Blade Length Panjang Bilah 锯片长度	750mm (29-1/2")
Strokes Per Minute (SPM) Kelajuan Strok 冲程速度	3,000
Tooth Spacing Selang Gigi 牙齿间隔	18mm (11/16")
Net Weight Keberatan 净重	4.4kg (9.7lbs.)
Power Supply Cord Kabel Wayar 电源线	0.3m (0.98ft)

EH6000W 600mm (23-5/8")

Petrol Hedge Trimmer

Pemangkas Tanaman Pagar Petrol
汽油篱笆修剪机



CATALYTIC
CONVERTER

- **The lightest 22.2cc petrol hedge trimmer with double-sided blade**
Trimmer petrol yang paling ringan dengan bilah dua sisi
最轻的22.2cc双面刀片汽油绿篱机

Standard Equipment: Blade Cover, Socket Wrench, Hex Wrench



Blade Length Panjang Bilah 锯片长度	600mm (23-5/8")
Displacement Sesaran 排量	22.2mL
Engine Power Kuasa Enjin 发动机功率	0.68kW/ 1.0PS
Fuel Tank Capacity Tangki Minyak 油箱容量	0.4L
Strokes Per Minute (SPM) Kelajuan Strok 冲程速度	4390
Tooth Spacing Selang Gigi 牙齿间隔	35mm (1-3/8")
Dimensions (L x W x H) Dimensi 体积	1,119x262x216mm (44"x10-3/8"x8-1/2")
Net Weight Berat Bersih 净重	5kg (11lbs)

EH5000W 500mm (19-3/4")

Petrol Hedge Trimmer

Pemangkas Tanaman Pagar Petrol
汽油篱笆修剪机



CATALYTIC
CONVERTER

- **Rotatable handle is convenient for various style operation**
Pemegang berputar mudah untuk pelbagai operasi
可旋转的手柄方便各种操作

Standard Equipment: Blade Cover, Socket Wrench, Hex Wrench



Blade Length Panjang Bilah 锯片长度	500mm (19-3/4")
Displacement Sesaran 排量	22.2mL
Engine Power Kuasa Enjin 发动机功率	0.68kW/ 1.0PS
Fuel Tank Capacity Tangki Minyak 油箱容量	0.4L
Strokes Per Minute (SPM) Kelajuan Strok 冲程速度	4390
Tooth Spacing Selang Gigi 牙齿间隔	35mm (1-3/8")
Dimensions (L x W x H) Dimensi 体积	1,014x262x216mm (40"x10-3/8"x8-1/2")
Net Weight Berat Bersih 净重	4.8kg (10.5lbs)

HTR7610 750mm (29-1/2")

Petrol Hedge Trimmer

Pemangkas Tanaman Pagar Petrol
汽油篱笆修剪机



- **Wide-trigger control and soft grip for comfortable operation**
Pencetus dan gengaman lembut untuk operasi yang selesa
宽触发控制和柔软的握柄舒适操作

Standard Equipment: Blade Cover, Tool set



Blade Length Panjang Bilah 锯片长度	750mm (29-1/2")
Displacement Sesaran 排量	24.5mL
Engine Power Kuasa Enjin 发动机功率	0.73kW/ 0.99PS
Fuel Tank Capacity Tangki Minyak 油箱容量	0.6L
Dimensions (L x W x H) Dimensi 体积	1,041x280x258mm (41"x11"x10-1/8")
Strokes Per Minute (SPM) Kelajuan Strok 冲程速度	3,600
Net Weight Berat Bersih 净重	5.4kg (11.9lbs)

EN4951SH 25.4mL 4-stroke

Petrol Pole Hedge Trimmer

Pemangkas Tanaman Pagar Tinggi Petrol
汽油高枝篱笆剪



- **Can be folded in the 180° position for easy transport and storage**
Boleh dilipat di kedudukan 180° untuk memudahkan pengangkutan dan penyimpanan
可以在180°的位置折叠，便于运输和储存

Standard Equipment: Blade Cover, Socket Wrench, Hex Wrench, Band Assembly



Displacement Sesaran 排量	25.4mL
Engine Power Kuasa Enjin 发动机功率	0.77kW/ 1.1PS
Fuel Tank Capacity Tangki Minyak 油箱容量	0.6L
Strokes Per Minute (SPM) Kelajuan Strok 冲程速度	4,200
Blade Length Panjang Batang Gergaji 切割长度	490mm (19-1/4")
Dimensions (L x W x H) Dimensi 体积	2,050x221x241mm (80-1/2"x8-3/4"x9-1/2")
Net Weight Berat Bersih 净重	6.6kg (14.6lbs)

Cordless
Tidak Perlu BekalLED Flashlight
Lampu Boleh LED
1500000 BTVacuum Cleaner
Penyedut Debu
2.5LDrilling / Fastening
Druai / Pasang
1/2"Impact Drilling / Demolition
Druai / Pasang
1/2"Cutting
MemotongGrinding / Sanding
Menggosok / MengkilapSawing
DapatPlaning / Routing
Mengukir / MengukirOthers
Lain-lainOutdoor Power Equipment
Alat Kuasa LuarMakita
1915

OUTDOOR POWER EQUIPMENT

PTR2500 24.5mL

Petrol Pole Trimmer
Pemangkas Tanaman Pagar
Tinggi Petrol
汽油高枝篱剪



- **Very powerful 2-stroke engine**
Enjin 2-strok yang berkuasa
强大的二冲程引擎

Standard Equipment: Band Assembly, Accessory Bag, Tool Set, Wrench, Safety Goggles



Displacement Sesaran 排量	24.5mL
Engine Power Kuasa Enjin 发动机功率	0.73kW / 0.99PS
Fuel Tank Capacity Tangki Minyak 油箱容量	0.65L
Dimensions (L x W x H) Dimensi 体积	2,400x350x220mm (94-1/2"x13-3/4"x8-5/8")
Net Weight Berat Bersih 净重	6.1kg (13.4lbs)

Powerful spray range up to 16m (52ft) horizontally

Penyembur yang berkuasa tinggi boleh menyembur sampai 16m (52ft) secara mendatar 强力喷雾系列，距离长达16m (52英尺)



Mosquito Spray Nozzles Part No. 196499-6 (Optional Accessories)

For users consider to reduce risk of getting disease from mosquito, the best option is using Makita Petrol Mist Blower with mosquito spray nozzle accessories.

Muncung penyembur untuk mengurangkan nyamuk

Untuk pengguna yang ingin mengurangkan risiko jangkitan dari nyamuk yang berpenyakit, pilihan yang terbaik adalah menggunakan Petrol Penyembur Makita dengan aksesori muncung penyembur nyamuk.

为降低蚊子疾病感染的风险，Makita 汽油喷雾机与蚊子喷嘴配件的搭配是最佳选择。

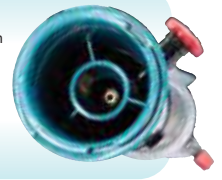

PM7650H 75.6mL 4-stroke

Mist Blower
Penyembur Petrol
汽油喷雾器



- **Excellent spray range performance up to 16m (52 ft) horizontally**
Semburan yang berprestasi tinggi sehingga 16m (52 kaki) secara mendatar
优秀的喷射性能水平高达16米(52英尺)

Standard Equipment: Hand Strap, Screwdriver, Diffusion Cover, Hose Clamp, Flexible Pipe, Straight Pipe



Displacement Sesaran 排量	75.6mL
Fuel Tank Capacity Tangki Minyak 油箱容量	1.8L
Max Air Volume Isipadu Angin Maksimum 最大风量	14.1m ³ /min (497CFM) The velocity of the wind (w/o blower pipes) 85m/s
Dimensions (L x W x H) Dimensi 体积	420x440x595mm (16-1/2"x17-1/4"x23-1/2")
Net Weight Keberatan 净重	13.9kg (30.6lbs)

EB7660TH 75.6mL 4-Stroke

Petrol Blower
Mesin Penghembus Angin Petrol
背负式汽油吹风机



- **Powerful fuel efficient 75.6mL MM4 commercial duty engine**
Enjin MM4 komersial 75.6mL yang cekap
强力工业用途四冲程吹风机

Standard Equipment: Oil (195532-1), Socket Wrench, Driver, Flexible Pipe, Swivel Pipe, Hose Clamp, End Nozzle, Flat Nozzle, Long Pipe, Short Pipe, Cable Holder, Accessory Bag



Displacement Sesaran 排量	75.6mL
Power Rating Kuasa 额定功率	3.0kW (4.1PS)
Max Air Volume Isipadu Angin Maksimum 最大风量	20m ³ /min (706CFM)
Max Air Velocity Velositi Angin Maksimum 最大风速	92m/s (205MPH)
Fuel Tank Capacity Tangki Minyak 油箱容量	1.9L (64oz.)
No Load Speed (RPM) Kelajuan Tanpa Beban 回转数	2,800 - 7,200
Max Torque Pemutaran Tenaga Maksimum 最大扭矩	4.7N·m
Dimensions (L x W x H) Dimensi 体积	332x460x480mm (13-1/8"x18-1/8"x18-7/8")
Net Weight Berat Bersih 净重	11.9 - 12.1kg (26.2 - 26.7lbs.)

EB5300TH 52.5mL 4-Stroke

Petrol Blower
Mesin Penghembus Angin Petrol
背负式汽油吹风机



- **Heavy duty anti-vibration mounts between frame and engine for improved operator comfort**
Bertugas berat dan anti getaran
强力，低振动和舒适的设计

Standard Equipment: Oil (198279-6), Box Wrench, Driver, Flexible Pipe, Swivel Pipe, Hose Clamp, End Nozzle, Flat Nozzle, Long Pipe, Short Pipe, Cable Holder, Accessory Bag



VIDEO CLIP
EB5300TH
Models and specs may vary by country

Displacement Sesaran 排量	52.5mL
Power Rating Kuasa 额定功率	1.8kW (2.5PS)
Max Air Volume Isipadu Angin Maksimum 最大风量	15m ³ /min (516CFM)
Max Air Velocity Velositi Angin Maksimum 最大风速	98m/s (220MPH)
Fuel Tank Capacity Tangki Minyak 油箱容量	1.8L (61oz.)
No Load Speed (RPM) Kelajuan Tanpa Beban 回转数	2,800 - 6,400
Max Torque Pemutaran Tenaga Maksimum 最大扭矩	3.0N·m
Dimensions (L x W x H) Dimensi 体积	320x450x475mm (12-5/8"x17-3/4"x18-3/4")
Net Weight Berat Bersih 净重	8.9kg (19.7lbs.)

Cordless
Tali Daya (Kord) / 充电式

LED Flashlight
Lampu Sesebuah LED
LED 闪光灯

Vacuum Cleaner
Penyedut Debu
吸尘器

Drilling / Flapening
Gasing / Pengaliran
电钻 / 磨床

Impact Drilling / Demolition
Gasing / Patahkan
电钻 / 电锤

Cutting
Penyempul
切割机

Grinding / Sanding
Majlis / Pasut
磨床 / 砂光机

Sawing
Gasing
电锯

Pruning / Rastering
Majlis / Pasut
电剪 / 电剪

Others
Lain-lain
其他

Outdoor Power Equipment
Alatan Elektrik Luar
户外动力设备

Makita
Makita

OUTDOOR POWER EQUIPMENT

BHX2500 24.5mL 4-stroke

Petrol Blower

Mesin Penghembus Angin Petrol
汽油吹风机



- 4-stroke engine requires no fuel mix. 4-stroke for low noise and low emission
Enjin 4 strok tidak perlu campuran minyak, bunyi rendah dan perlepasan asap rendah
四冲程引擎，无需混合燃料，低噪音，无排气

Standard Equipment: Pipe, Nozzle, Socket Wrench



Displacement Sesaran 排量	24.5mL
Power Rating Kuasa 额定功率	0.81kW
Max Air Volume Isipadu Angin Maksimum 最大风量	10.1m ³ /min (356CFM)
Max Air Velocity Velositi Angin Maksimum 最大风速	65m/s (145MPH)
Fuel Tank Capacity Tangki Minyak 油箱容量	0.52L (17.6oz.)
No Load Speed (RPM) Kelajuan Tanpa Beban 回转速数	3,500 - 7,800
Dimensions (L x W x H) Dimensi 体积	350x231x368mm (13.8"x9.1"x14.5")
Net Weight Berat Bersih 淨重	4.5kg (9.8lbs)

ELM4121 410mm (16-1/8")

Electric Lawn Mower

Mesin Pemotong Rumput
电手推割草机



- Robust steel cutting deck for increased durability
Dek keluli memotong untuk meningkat ketahanan
钢制切割台提高其耐用性

Standard Equipment: Blade, Wrench, Mulch Plug



Continuous Rating Input Input Kuasa Berterusan 额定输入功率	1,600W
Hole Diameter Diameter Lubang 孔直径	8mm (5/16")
Cutting Width Lebar Keratan 切割宽度	410mm (16-1/8")
Cutting Height Ketinggian Pemotongan 切割高度	20 - 75mm (13/16" - 2-15/16")
No Load Speed (RPM) Kelajuan Tanpa Beban 回转速数	3,400
Recommended mowing area up to Julat Memotong yang Disyorkan 推荐的割草范围	600m ²
Grass Box Capacity Kapasiti Kotak Rumput 草箱容量	50L
Wheel Size Saiz Roda 轮片尺寸	Front / Rear: 156 / 200mm (6-1/8 / 7-7/8")
Dimensions (L x W x H) Dimensi 体积	1,465x530x905-1,135mm (57-3/4"x20-7/8"x35-5/8" - 44-3/4")
Net Weight Berat Bersih 淨重	17.5 - 19.1kg (38.6 - 42.1lbs.)

ELM3720 370mm (14-1/2")

Electric Lawn Mower

Mesin Pemotong Rumput
电手推割草机



- Stays upright for easy maintenance and cleaning
Penyelenggaraan dan pembersihan lebih mudah
简单维护和清洁

Standard Equipment: Blade, Wrench



Continuous Rating Input Input Kuasa Berterusan 额定输入功率	1,400W
Hole Diameter Diameter Lubang 孔直径	8mm (5/16")
Cutting Width Lebar Keratan 切割宽度	370mm (14-1/2")
Cutting Height Ketinggian Pemotongan 切割高度	20 - 55mm (13/16" - 2-3/16")
No Load Speed (RPM) Kelajuan Tanpa Beban 回转速数	3,400
Recommended mowing area up to Julat Memotong yang Disyorkan 推荐的割草范围	500m ²
Grass Box Capacity Kapasiti Kotak Rumput 草箱容量	40L
Wheel Size Saiz Roda 轮片尺寸	Front / Rear: 139 / 178mm (5-1/2 / 7")
Dimensions (L x W x H) Dimensi 体积	1,330x415x890-1,120mm (52-3/8"x16-3/8"x35" - 44")
Net Weight Berat Bersih 淨重	11.6kg (25.6lbs.)

ELM3711X 370mm (14-1/2")

Electric Lawn Mower

Mesin Pemotong Rumput
电手推割草机

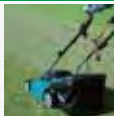

- Silent and NO emission
Senyap dan tanpa perlepasan asap
低噪音，无排气

Standard Equipment: Blade



Continuous Rating Input Input Kuasa Berterusan 额定输入功率	1,400W
Cutting Width Lebar Keratan 切割宽度	370mm (14-1/2")
Cutting Height Ketinggian Pemotongan 切割高度	20,40,55mm (13/16, 1-9/16, 2-3/16")
No Load Speed (RPM) Kelajuan Tanpa Beban 回转速数	2,900
Recommended Mowing Area up to Julat memotong yang disyorkan 推荐的割草范围	500m ²
Grass Box Capacity Kapasiti Kotak Rumput 草箱容量	35L
Dimensions (L x W x H) Dimensi 体积	662x412x312mm (26"x16-1/2"x12-5/8")
Net Weight Berat Bersih 淨重	14.8kg (32.6lbs)

ELM3320 330mm (13")

Electric Lawn Mower

Mesin Pemotong Rumput
电手推割草机

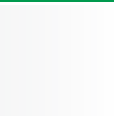

- Stays upright for easy maintenance and cleaning
Penyelenggaraan dan pembersihan lebih mudah
简单维护和清洁

Standard Equipment: Blade, Wrench



Continuous Rating Input Input Kuasa Berterusan 额定输入功率	1,200W
Hole Diameter Diameter Lubang 孔直径	8mm (5/16")
Cutting Width Lebar Keratan 切割宽度	330mm (13")
Cutting Height Ketinggian Pemotongan 切割高度	20 - 55mm (13/16" - 2-3/16")
No Load Speed (RPM) Kelajuan Tanpa Beban 回转速数	3,400
Recommended mowing area up to Julat Memotong yang Disyorkan 推荐的割草范围	400m ²
Grass Box Capacity Kapasiti Kotak Rumput 草箱容量	30L
Wheel Size Saiz Roda 轮片尺寸	Front / Rear: 139 / 178mm (5-1/2 / 7")
Dimensions (L x W x H) Dimensi 体积	1,230x380x870-1,110mm (48-1/2"x15"x34-1/4" - 43-3/4")
Net Weight Berat Bersih 淨重	10.2kg (22.5lbs.)

OUTDOOR POWER EQUIPMENT

ELM3311X 330mm (13")

Electric Lawn Mower

Mesin Pemotong Rumput
电手推割草机

- **Wheels tucked under body to enhance performance**
Roda bawah badan mesin untuk meningkatkan prestasi
轮子隐藏在机身下提高性能



Sementara stok masih ada 售完即止
WHILE STOCK LAST

Continuous Rating Input Input Kuasa Berterusan 额定输入功率	1,100W
Cutting Width Lebar Keratan 切割宽度	330mm (13")
Cutting Height Ketinggian Pemotongan 切割高度	20,40,55mm (13/16, 1-9/16, 2-3/16")
No Load Speed (RPM) Kelajuan Tanpa Beban 回转数	2,900
Recommended Mowing Area up to Julat memotong yang disyorkan 推荐的割草范围	400m ²
Grass Box Capacity Kapasiti Kotak Rumput 草箱容量	27L
Dimensions (L x W x H) Dimensi 体积	621x376x312mm (24-1/2"x14-3/4"x12-1/4")
Net Weight Berat Bersih 净重	13.0kg (28.7lbs)



PLM5120N2 510mm (20")

Petrol Lawn Mower

Mesin Pemotong Rumput Petrol
汽油手推割草机

- **4-stroke engine requires no fuel mix**
Enjin 4 strok tidak perlu campuran minyak
四冲程引擎，无需混合燃料



Engine Enjin 发动机	B&S625E R/S, 150mL
Engine Power Kuasa Enjin 发动机功率	2.2kW/ N/A PS
Cutting Width Lebar Keratan 切割宽度	510mm (20")
Cutting Height Ketinggian Pemotongan 切割高度	25 - 70mm (1" - 2-3/4")
No Load Speed (RPM) Kelajuan Tanpa Beban 回转数	2,800
Recommended Mowing Area up to Julat Memotong yang Disyorkan 推荐的割草范围	1,500m ²
Fuel Tank Capacity Tangki Minyak 油箱容量	0.8L (N/A oz.)
Oil Tank Capacity Kapasiti Tangki Minyak 润滑油箱	0.47L (N/A oz.)
Dimensions (L x W x H) Dimensi 体积	850x560x375mm (33-1/2"x22"x14-3/4")
Net Weight Berat Bersih 净重	25.5kg (57.3lbs.)

Standard Equipment: Blade, Box Wrench,
Side Discharge Channel



PLM4620N2 460mm (18-1/8")

Petrol Lawn Mower

Mesin Pemotong Rumput Petrol
汽油手推割草机

- **Brake for maximum productivity and increased operator safety**
Brek untuk produktiviti maksimum dan keselamatan pengguna
电刹车器增加使用者的安全



Sementara stok masih ada 售完即止
WHILE STOCK LAST

Engine Enjin 发动机	B&S625E R/S, 150mL
Engine Power Kuasa Enjin 发动机功率	2.2kW/ N/A PS
Cutting Width Lebar Keratan 切割宽度	460mm (18-1/8")
Cutting Height Ketinggian Pemotongan 切割高度	25 - 70mm (1" - 2-3/4")
No Load Speed (RPM) Kelajuan Tanpa Beban 回转数	2,800
Recommended Mowing Area up to Julat Memotong yang Disyorkan 推荐的割草范围	1,200m ²
Grass Box Capacity Kapasiti Kotak Rumput 草箱容量	60L
Fuel Tank Capacity Tangki Minyak 油箱容量	Fuel: 0.8L (N/A oz.) Oil: 0.47L (N/A oz.)
Dimensions (L x W x H) Dimensi 体积	800x540x400mm (31-1/2"x21-1/4"x15-3/4")
Net Weight Berat Bersih 净重	27.6kg (60.9lbs.)

Standard Equipment: Blade, Box Wrench, Mulch plug



EK7651H / X1 355mm (14")

Power Cutter

Pemotong Berkuasa
汽油切断机

- **Save cost of the power cutter with fuel savings alone**
Kos operasi yang rendah
节省燃油



- **X1: Come with Diamond Wheel (B-13465), Oil (195532-D)**



EK7651H

VIDEO CLIP
Models and specs may vary by country



Wheel Diameter Diameter Roda 轮片直径	355mm (14")
Engine Enjin 发动机	75.6mL
Max Cutting Depth Kedalaman Pemotongan Maksimum 最大切割深度	122mm (4-13/16")
No Load Speed (RPM) Kelajuan Tanpa Beban 回转数	4,300
Circumferential Speed Kelajuan 圆周速度	80m/s
Engine Power Kuasa Enjin 发动机功率	3.0kW/ 4.1PS
Fuel Tank Capacity Tangki Minyak 油箱容量	1.1L
Dimensions (L x W x H) Dimensi 体积	780x310x455mm (30-3/4"x12-1/4"x17-7/8")
Net Weight Berat Bersih 净重	14.2kg (31.3lbs)

EK6101 355mm (14")

Power Cutter

Pemotong Berkuasa
汽油切断机

- **Smaller hub and drive wheel for increases maximum cutting depth**
Hab kecil dan roda pemacu untuk meningkatkan pemotongan kedalaman maksimum
较小的轮毂和驱动轮可增加最大切割深度



Wheel Diameter Diameter Roda 轮片直径	355mm (14")
Engine Enjin 发动机	61mL
Max Cutting Depth Kedalaman Pemotongan Maksimum 最大切割深度	130mm (5-1/8")
No Load Speed (RPM) Kelajuan Tanpa Beban 回转数	4,400
Circumferential Speed Kelajuan 圆周速度	80m/s
Engine Power Kuasa Enjin 发动机功率	3.2kW/ 4.4PS
Fuel Tank Capacity Tangki Minyak 油箱容量	0.7L
Overall Length Dimensi 体积	730mm (28-3/4")
Net Weight Berat Bersih 净重	8.8kg (19.4lbs)

Standard Equipment: Wrenches, Screwdriver



Cordless
Taliwaykutan (B&S)

LED Flashlight
Lampu suluh LED
- LCM001

Vacuum Cleaner
Penyedut Debu
- VCS01

Drilling / Flapening
Gergaji / Penghalus
- DR01 / DR02

Impact Drilling / Demolition
Gergaji / Patahkan
- DR03 / DR04

Impact Drilling / Demolition
Gergaji / Patahkan
- DR05 / DR06

Cutting
Pemotong
- CLP

Grinding / Sanding
Gergaji / Pasut
- GR01 / GR02

Sawing
Gergaji
- S01

Pruning / Rastering
Pajutan / Tautan
- PR01 / PR02

Others
Lain-lain
- J01

Outdoor Power Equipment
Alatan kuasa luar
- OPE

Trakita
- TRK

OUTDOOR POWER EQUIPMENT

Cordless
無線電動工具

LED Flashlight
LED 高亮 LED
150000000

Vacuum Cleaner
吸尘器
2000W

Drilling / Fastening
钻孔 / 紧固
MAX. 1000

Impact Drilling / Demolition
冲击钻 / 拆除
6.5MM, 1.3MM, 2.2

Cutting
切割
2000W

Grinding / Sanding
打磨 / 砂光
2000W

Sawing
锯切
2000W

Planing / Routing
刨平 / 铣削
2000W

Others
其他
2000W

Outdoor Power Equipment
户外动力设备
2000W

Makita
MAKITA



Powerful Washing

VARIOUS OPTIONS
Pelbagai pilihan
各种选择

- Trigger gun set
Part No. 197842-2
- Variable nozzle set
Part No. 197822-8
- Cyclone jet nozzle set
Part No. 197824-4
- Cyclone guard set
Part No. 197864-2
- Variospray lance set
Part No. 197876-5
- Under body spray lance set
Part No. 198909-9
- Extension pipe set
Part No. 197870-7
- Rotating brush set
Part No. 197831-7
- Wash brush set
Part No. 197828-6
- Foam nozzle set
Part No. 197886-2
- Pipe cleaning hose
Part No. 197837-5
- Self-suction hose set
Part No. 197873-1

Makita
MAKITA

OUTDOOR POWER EQUIPMENT



HW1300

High Pressure Washer

Pembersih Tekanan Tinggi
高压清洗机



- **Eco-friendly for reduced water**
Mesra alam dengan pengurangan kegunaan air
环保与减少用水量

Standard Equipment: Trigger Gun, Vario-Power Spray Lance, Cyclone jet nozzle, Detergent Bottle, Cleaner Pin, Coupling Sleeve, High Pressure Hose 10m, Water Hose Connector, Foam Nozzle, Connector



Continuous Rating Input Input Kuasa Berterusan 额定输入功率	1,800W
Max Pressure Tekanan Maksimum 最大水压	13MPa (130bar, 1,885PSI)
Max Flow Rate Aliran Air Maksimum 最大流量	420L/h
Max Input Temperature Ketahanan Suhu Air 最大输入温度	40°C (104°F)
High Pressure Hose Length Hos Tekanan 高压软管长度	10m (33ft.)
Dimensions (L x W x H) Dimensi 体积	292x358x830mm (11-1/2"x14-1/8"x32-3/4")
Net Weight Berat Bersih 净重	12.7kg (28.0lbs.)
Power Supply Cord Kabel Wayer 电源线	5.0m (16.4ft.)

HW1200

High Pressure Washer

Pembersih Tekanan Tinggi
高压清洗机



- **Uses up to 80% less water than a garden hose while delivering up to 50X the pressure**
Memberikan tekanan 50 kali ganda lebih daripada hos biasa dan menjimatkan 80% penggunaan air berbanding dengan hos biasa
用水量比园艺软管少80%，同时可提供高达50倍的水压力

Standard Equipment: Trigger Gun, Vario-Power Spray Lance, Cyclone jet nozzle, Detergent Bottle, Cleaner Pin, Coupling Sleeve, High Pressure Hose 10m, Water Hose Connector, Foam Nozzle, Connector



Continuous Rating Input Input Kuasa Berterusan 额定输入功率	1,800W
Max Pressure Tekanan Maksimum 最大水压	12MPa (120bar, 1,740PSI)
Max Flow Rate Aliran Air Maksimum 最大流量	420L/h
Max Input Temperature Ketahanan Suhu Air 最大输入温度	40°C (104°F)
High Pressure Hose Length Hos Tekanan 高压软管长度	10m (33 ft.)
Dimensions (L x W x H) Dimensi 体积	292x358x830mm (11-1/2"x14-1/8"x32-3/4")
Net Weight Berat Bersih 净重	11.0kg (24.3lbs.)
Power Supply Cord Kabel Wayer 电源线	5.0m (16.4ft.)

HW121

High Pressure Washer

Pembersih Tekanan Tinggi
高压清洗机



- **Made for frequent usage on larger, dirty or very dirty areas**
Sesuai untuk pembersihan kerap di tempat yang luas dan kotoran yang degil
适用于清洗较大的面积和极度肮脏的地方

Continuous Rating Input Kuasa 额定输入功率	2,100W
Max Pressure Tekanan Maksimum 最大水压	13MPa (130bar, 1,885PSI)
Max Flow Rate Aliran Air Maksimum 最大流量	390L/h
Motor Type Enjin 马达类型	Induction
Max Input Temperature Ketahanan Suhu Air 最大输入温度	50°C (122°F)
High Pressure Hose Length Hos Tekanan 高压软管长度	8m (26.3ft.)
Net Weight Berat Bersih 净重	17.8kg (39.2lbs.)

HW102

High Pressure Washer

Pembersih Tekanan Tinggi
高压清洗机



- **Lightweight and compact power washer for home**
Ringan dan padat, sesuai untuk kegunaan rumah
轻量家用高压清洗机

Continuous Rating Input Kuasa 额定输入功率	1,300W
Max Pressure Tekanan Maksimum 最大水压	10MPa (100bar, 1,450PSI)
Max Flow Rate Aliran Air Maksimum 最大流量	360L/h
Motor Type Enjin 马达类型	Universal
Max Input Temperature Ketahanan Suhu Air 最大输入温度	50°C (122°F)
High Pressure Hose Length Hos Tekanan 高压软管长度	5m (16.4ft.)
Net Weight Berat Bersih 净重	5.8kg (12.8lbs.)



Cordless
Taliway (Kabel) (無線)

LED Flashlight
Lampu Sinar LED
LED (無線)

Vacuum Cleaner
Penyedut Debu
(無線)

Drilling / Flapening
Dua / Penebat
M12 / M14

Impact Drilling / Demolition
Dua / Penebat
M12 / M14 / M16 / M18

Cutting
Penebat
CUT

Grinding / Sanding
Penebat / Penebat
M12 / M18

Sawing
Dua
SIC

Planing / Routing
Penebat / Penebat
M12 / M18

Others
Lain-lain
LAIN

Outdoor Power Equipment
Alatan Kaji Laju
LAIN-LAIN

Makita
Makita

Cordless
Tanpa Kabel Listrik

LED Flashlight
Lampu Suhu LED
LED Lamp

Vacuum Cleaner
Pembersih Vakum
吸尘器

Drilling | Fastening
Gerudi | Pengikat
钻孔 | 紧固

Impact Drilling | Demolition
Gerudi | Pemecah
石工钻孔 | 砸裂加工

Cutting
Pemotong
切割

Grinding | Sanding
Pengisar | Pelsih
研磨 | 打磨

Sawing
Gergaji
锯切

Planing | Routersing
Pergesam | Tanggam
刨削 | 雕刻

Others
Lain-lain
其他

Outdoor Power Equipment
Alat-alat Kerja Luar
園林·戶外



M6501G / M6501B 6.5mm (1/4") 85

High Speed Drill
Gerudi Kelajuan Tinggi
高速钻

- Ideal for drilling smaller holes in wood & steel
• Sesuai untuk penggerudian lubang lebih kecil pada bahan kayu atau logam
• 适用于木材和钢材上钻孔



Standard Equipment: Chuck Key



Continuous Rating Input Input Kuasa Berterusan 额定输入功率	230W
Capacity Kapasiti 能力	Steel: 6.5mm (1/4") Wood: 9mm (11/32")
No Load Speed (RPM) Kelajuan Tanpa Beban 回转数	0 - 4,500
Dimensions (L x W x H) Dimensi 体积	203x63x171mm (8"x2-1/2"x6-3/4")
Net Weight Berat Bersih 净重	0.95kg (2.1lbs)
Power Supply Cord Panjang Kord 电源线	2.0m (6.6ft.)

M0600G / M0600B 10mm (3/8") 64

Drill
Gerudi
电钻

- Powerful 350W motor for continuous operation
• Motor berkuasa 350W untuk operasi berterusan
• 强力350W马达可持续运作



Standard Equipment: Chuck Key, Chuck Key Holder



Continuous Rating Input Input Kuasa Berterusan 额定输入功率	350W
Capacity Kapasiti 能力	Steel: 10mm (3/8") Wood: 20mm (13/16")
No Load Speed (RPM) Kelajuan Tanpa Beban 回转数	0 - 3,000
Dimensions (L x W x H) Dimensi 体积	230x66x176mm (9"x2-5/8"x6-15/16")
Net Weight Berat Bersih 净重	1.2kg (2.6lbs)
Power Supply Cord Panjang Kord 电源线	2.0m (6.6ft.)

M6001G / M6001B 10mm (3/8") 85

Drill
Gerudi
电钻

- Powerful 450W motor for continuous operation
• Motor berkuasa 450W untuk operasi berterusan
• 强力450W马达可持续运作



Standard Equipment: Chuck Key



Continuous Rating Input Input Kuasa Berterusan 额定输入功率	450W
Capacity Kapasiti 能力	Steel: 10mm (3/8") Wood: 25mm (1")
No Load Speed (RPM) Kelajuan Tanpa Beban 回转数	0 - 3,000
Dimensions (L x W x H) Dimensi 体积	229x64x175mm (9"x2-1/2"x6-7/8")
Net Weight Berat Bersih 净重	1.3kg (2.9lbs)
Power Supply Cord Panjang Kord 电源线	2.0m (6.6ft.)

M6200G / M6200B 13mm (1/2") 303

Drill
Gerudi
电钻

- Powerful 800W motor with variable speed for improved mixing and drilling performance
• Motor berkuasa 800W dengan Pilihan kawalan kelajuan berubah untuk prestasi pencampuran dan penggerudian yang lebih baik
• 强力800W马达配备变速控制功率提高混合和钻孔性能

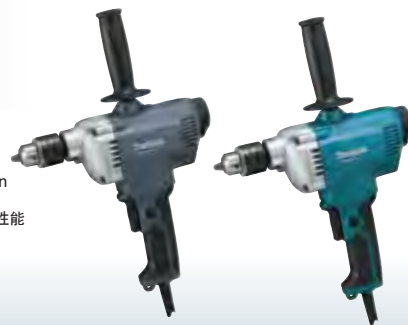

Standard Equipment: Chuck Key, Top Grip



Continuous Rating Input Input Kuasa Berterusan 额定输入功率	800W
Capacity Kapasiti 能力	Steel: 13mm (1/2") Wood: 36mm (1-7/16")
No Load Speed (RPM) Kelajuan Tanpa Beban 回转数	0 - 700
Dimensions (L x W x H) Dimensi 体积	267x86x388mm (10-1/2"x3-3/8"x15-1/4")
Net Weight Berat Bersih 净重	2.7kg (6.0lbs.)
Power Supply Cord Panjang Kord 电源线	2.0m (6.6ft.)

M6600XG / M6600XB 303

Mixer
Pengadun
搅拌机

- Powerful 800W motor for improved mixing and drilling performance
• Motor berkuasa 800W untuk prestasi pencampuran dan penggerudian yang lebih baik
• 强力800W马达提高混合和钻孔性能

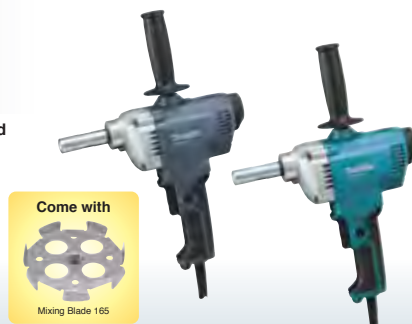

Standard Equipment: Mixing Blade, Shaft, Top Grip, Wrenches



Continuous Rating Input Input Kuasa Berterusan 额定输入功率	800W
Blade Diameter Diameter Bilah 锯片直径	165mm (6-1/2")
No Load Speed (RPM) Kelajuan Tanpa Beban 回转数	0 - 700
Dimensions (L x W x H) Dimensi 体积	280x86x388mm (11"x3-3/8"x15-1/4")
Net Weight Berat Bersih 净重	2.6kg (5.7lbs.)
Power Supply Cord Panjang Kord 电源线	2.0m (6.6ft.)

Cordless
Tempa Kord 无绳式

LED Flashlight
Lampu Suhu LED
LED照明灯

Vacuum Cleaner
Pembersih Vakuum
吸尘器

Drilling | Fastening
Gerudi | Pengikat
钻孔 | 紧固

Impact Drilling | Demolition
Gerudi | Pemecah
石工钻孔 | 拆毁加工

Cutting
Pemotong
切割

Grinding | Sanding
Pengisar | Pelsin
研磨 | 打磨

Sawing
Gergaji
锯切

Planing | Routing
Pengaliran | Tanggaman
刨削 | 雕花

Others
Lain-lain
其他

Outdoor Power Equipment
Alatan Kerja Luar
园机/户外



Cordless
Tanpa Kord Listrik

LED Flashlight
Lampu Suluh LED
LED 照明灯

Vacuum Cleaner
Pembersih Vakum
吸尘器

Drilling / Fastening
Gerudi / Pengikat
钻孔 / 紧固

Impact Drilling / Demolition
Gerudi / Pemecah
石工钻孔 / 砸裂加工

Cutting
Pemotong
切割

Grinding / Sanding
Pengisar / Pelsih
研磨 / 打磨

Sawing
Gergaji
锯切

Planing / Routing
Pengalir / Tanggung
刨削 / 雕刻

Others
Lain-lain
其他

Outdoor Power Equipment
Alat-alat Kerja Luar
园林-户外

M8103G / M8103B 13mm (1/2")

85

Hammer Drill

Gerudi Tukul
冲击电钻



- 2-mode operation for hammering with rotation or rotation only
Operasi 2 mod, penukulan dengan putaran atau hanya putaran
2档模式变换: 旋转并锤击或仅旋转

Standard Equipment: Chuck Key, Side Grip, Chuck Key Holder



Continuous Rating Input Input Kuasa Berterusan 额定输入功率	430W
Capacity Kapasiti 能力	Concrete: 13mm (1/2") Steel: 13mm (1/2") Wood: 18mm (11/16")
Impacts Per Minute (IPM) Impak Per Minit 冲击数	0 - 33,000
No Load Speed (RPM) Kelajuan Tanpa Beban 回转数	0 - 3,000
Dimensions (L x W x H) Dimensi 体积	255x72x193mm (10"x2-13/16"x7-5/8")
Net Weight Berat Bersih 净重	1.8kg (3.9lbs)
Power Supply Cord Panjang Kord 电源线	2.0m (6.6ft)

M0801G / M0801B 16mm (5/8")

85

Hammer Drill

Gerudi Tukul
冲击电钻



- 2-mode operation for hammering with rotation or rotation only
Operasi 2 mod, penukulan dengan putaran atau hanya putaran
2档模式变换: 旋转并锤击或仅旋转

Standard Equipment: Chuck Key, Side Grip



Continuous Rating Input Input Kuasa Berterusan 额定输入功率	500W
Capacity Kapasiti 能力	Concrete: 16mm (5/8") Steel: 13mm (1/2") Wood: 20mm (13/16")
Impacts Per Minute (IPM) Impak Per Minit 冲击数	0 - 48,000
No Load Speed (RPM) Kelajuan Tanpa Beban 回转数	0 - 3,200
Dimensions (L x W x H) Dimensi 体积	261x69x195mm (10-1/4"x2-3/4"x7-5/8")
Net Weight Berat Bersih 净重	1.7kg (3.7lbs)
Power Supply Cord Panjang Kord 电源线	2.0m (6.6ft)

M8100G / M8100B 16mm (5/8")

85

Hammer Drill

Gerudi Tukul
冲击电钻



- 2-mode operation for hammering with rotation or rotation only
Operasi 2 mod, penukulan dengan putaran atau hanya putaran
2档模式变换: 旋转并锤击或仅旋转

Standard Equipment: Chuck Key, Side Grip, Depth Gauge



Continuous Rating Input Input Kuasa Berterusan 额定输入功率	710W
Capacity Kapasiti 能力	Concrete: 16mm (5/8") Steel: 13mm (1/2") Wood: 30mm (1-3/16")
Impacts Per Minute (IPM) Impak Per Minit 冲击数	0 - 48,000
No Load Speed (RPM) Kelajuan Tanpa Beban 回转数	0 - 3,200
Dimensions (L x W x H) Dimensi 体积	296x77x202mm (11-5/8"x3"x8")
Net Weight Berat Bersih 净重	2.1kg (4.6lbs.)
Power Supply Cord Panjang Kord 电源线	2.0m (6.6ft.)

M8700G / M8700B 22mm (7/8")

459

Rotary Hammer

Tukul Putar
电锤



- 2-mode operation for hammering with rotation or rotation only
Operasi 2 mod, penukulan dengan putaran atau hanya putaran
2档模式变换: 旋转并锤击或仅旋转

Standard Equipment: Side Grip, Depth Gauge



Continuous Rating Input Input Kuasa Berterusan 额定输入功率	710W
Impact Energy Kekuatan Impak 单次最大锤击力	EPTA-Procedure 05/2009: 1.9J Our experimental conditions: N/A J
Capacity Kapasiti 能力	Concrete: 22mm (7/8") Core Bit: 54mm (2-1/8") Diamond Core Bit (Dry Type): 65mm (2-9/16") Steel: 13mm (1/2") Wood: 32mm (1-1/4")
Impacts Per Minute (IPM) Impak Per Minit 冲击数	0 - 4,350
No Load Speed (RPM) Kelajuan Tanpa Beban 回转数	0 - 1,100
Dimensions (L x W x H) Dimensi 体积	362x71x194mm (14-1/4"x2-13/16"x7-5/8")
Net Weight Berat Bersih 净重	2.5 - 2.9kg (5.6 - 6.4lbs)
Power Supply Cord Panjang Kord 电源线	4.0m (13.1ft.)

M8701X3G / M8701X3B

459

Combination Hammer

Tukul Kombinasi
冲击电钻电锤



- 3-mode operating - rotation only, hammering with rotation, hammering only
Operasi 3 mod: hanya putaran, penukulan dengan putaran, hanya penukulan
3档模式变换: 仅旋转, 旋转并锤击, 仅锤击

Standard Equipment:
Side Grip, Depth Gauge, Drill Chuck, SDS-Plus Chisel Assortment 3pcs Set (D-30134)



Continuous Rating Input Input Kuasa Berterusan 额定输入功率	800W
Impact Energy Kekuatan Impak 单次最大锤击力	EPTA-Procedure 05/2009 : 2.3J Our experimental conditions: N/A J
Capacity Kapasiti 能力	Concrete : 26mm (1") Core Bit: 68mm (2-11/16") Diamond Core Bit (Dry Type): 80mm (3-1/8") Steel : 13mm (1/2") Wood : 32mm (1-1/4")
Impacts per minute (ipm) Impak Per Minit 冲击数	0-4,500
No Load Speed (RPM) Kelajuan Tanpa Beban 回转数	0-1,200
Dimensions (L x W x H) Dimensi 体积	362x71x194mm (14-1/4"x2-13/16"x7-5/8")
Net Weight Berat Bersih 净重	2.7kg (6.0lbs)
Power Supply Cord Panjang Kord 电源线	4.0m (13.1ft)

M8600G / M8600B 17mm (11/16") Hex Shank

105

Demolition Hammer

Tukul Elektrik
电动锤

- Satisfactory chipping performance
Prestasi penyerpihan yang memuaskan
卓越碎击性能



Standard Equipment: Bull Point, Side Grip



Continuous Rating Input Input Kuasa Berterusan 额定输入功率	900W
Impact Energy Kekuatan Impak 单次最大锤击力	7.2J
Impacts Per Minute (IPM) Impak Per Minit 冲击数	2,900
Dimensions (L x W x H) Dimensi 体积	406x99x232mm (16"x3-7/8"x9-1/8")
Net Weight Berat Bersih 净重	5.4kg (12lbs)
Power Supply Cord Panjang Kord 电源线	2.5m (8.2ft)

Cordless
Tangas Kord 无绳式

LED Flashlight
Lampu Suluh LED
LED照灯

Vacuum Cleaner
Pembersih Vakuum
吸尘器

Drilling | Fastening
Gerudi | Pasang
钻孔 | 紧固

Impact Drilling | Demolition
Gerudi | Pemecah
石工钻孔 | 凿裂加工

Cutting
Pemotong
切割

Grinding | Sanding
Pengisar | Pelsin
研磨 | 砂磨

Sawing
Gergaji
锯切

Planing | Routing
Pengaliran | Tanggaman
刨削 | 雕刻

Others
Lain-lain
其他

Outdoor Power Equipment
Alatan Kerja Luar
园机/户外



M9509G / M9509B

Slide Switch
Suis Gelasar 滑动开关

M9513G / M9513B

Toggle Switch
Suis Togol 后置式开关

325

M9509G / M9509B | M9513G / M9513B 100mm (4")

Angle Grinder
Pengisar Sudut 角向磨光机

- Powerful 850W motor for the most demanding applications
Motor berkuasa 850W untuk aplikasi yang paling mencabar
强力850W马达适合严峻使用

Standard Equipment: M9509G: Side Grip, Lock Nut Wrench
M9513G: Side Grip



Continuous Rating Input Input Kuasa Berterusan 额定输入功率	850W
Wheel Diameter Diameter Roda 轮片直径	100mm (4")
No Load Speed (RPM) Kelajuan Tanpa Beban 回转数	11,000
Dimensions (L x W x H) Dimensi 体积	276x118x101mm M9509G (10-7/8"x4-5/8"x4") 273x118x101mm M9513G (10-3/4"x4-5/8"x4")
Net Weight Berat Bersih 净重	1.8kg (3.9lbs)
Power Supply Cord Panjang Kord 电源线	2.0m (6.6ft)

M9506G / M9506B

Slide Switch
Suis Gelasar 滑动开关

M9512G / M9512B

Toggle Switch
Suis Togol 后置式开关

459

M9506G / M9506B | M9512G / M9512B 100mm (4")

Angle Grinder
Pengisar Sudut 角向磨光机

- Powerful 720W motor for the most demanding applications
Motor berkuasa 720W untuk aplikasi yang paling mencabar
强力720W马达适合严峻使用

Standard Equipment: Side Grip, Lock Nut Wrench



Continuous Rating Input Input Kuasa Berterusan 额定输入功率	720W
Wheel Diameter Diameter Roda 轮片直径	100mm (4")
No Load Speed (RPM) Kelajuan Tanpa Beban 回转数	11,000
Dimensions (L x W x H) Dimensi 体积	261x118x101mm M9506G (10-1/4"x4-5/8"x4") 258x118x101mm M9512G (10-1/8"x4-5/8"x4")
Net Weight Berat Bersih 净重	1.6kg (3.6lbs)
Power Supply Cord Panjang Kord 电源线	2.0m (6.6ft)

M0900G / M0900B

Top Slide Switch
Suis Gelasar Atas 顶部滑动开关
Convenient for left & right handed
Mudah diguna dengan tangan
kiri atau kanan 方便左右手

M0910G / M0910B

Toggle Switch
Suis Togol 后置式开关

459

M0900G / M0900B | M0910G / M0910B 100mm (4")

Angle Grinder
Pengisar Sudut 角向磨光机

- High performance and durability
Prestasi dan ketahanan tinggi
高性能与持久耐用

Standard Equipment: Lock Nut Wrench



Continuous Rating Input Input Kuasa Berterusan 额定输入功率	540W
Wheel Diameter Diameter Roda 轮片直径	100mm (4")
No Load Speed (RPM) Kelajuan Tanpa Beban 回转数	12,000
Dimensions (L x W x H) Dimensi 体积	251x118x97mm M0900G (9-7/8"x4-5/8"x3-13/16") 251x118x93mm M0910G (9-7/8"x4-5/8"x3-5/8")
Net Weight Berat Bersih 净重	1.6kg (3.5lbs)
Power Supply Cord Panjang Kord 电源线	2.0m (6.6ft)

M9504G 100mm (4")

411

Angle Grinder
Pengisar Sudut
角向磨光机

Toggle Switch
Suis Togol 后置式开关

- High performance and durability
Prestasi dan ketahanan tinggi
高性能与持久耐用

Standard Equipment:
Lock Nut Wrench

Continuous Rating Input 570W

Input Kuasa Berterusan 额定输入功率

Wheel Diameter 100mm (4")

Diameter Roda 轮片直径

No Load Speed (RPM) 12,000

Kelajuan Tanpa Beban 回转速数

Dimensions (L x W x H) 256x118x92mm

Dimensi 体积

Net Weight 1.8kg (4.0lbs.)

Berat Bersih 净重

Power Supply Cord 2.0m (6.6ft)

Panjang Kord 电源线

M9511G / M9511B 125mm (5")

325

Angle Grinder
Pengisar Sudut
角向磨光机

Slide Switch
Suis Gelangsar 滑动开关

- Slimmer barrel grip with easy gripping
and handling
Memberikan prestasi kawalan unggul dan keselesaan
提供更优异的控制性能和舒适度

Standard Equipment:
Side Grip, Lock Nut Wrench

Continuous Rating Input 850W

Input Kuasa Berterusan 额定输入功率

Wheel Diameter 125mm (5")

Diameter Roda 轮片直径

No Load Speed (RPM) 11,000

Kelajuan Tanpa Beban 回转速数

Dimensions (L x W x H) 276x140x111mm

Dimensi 体积

Net Weight 2.0kg (4.5lbs)

Berat Bersih 净重

Power Supply Cord 2.0m (6.6ft)

Panjang Kord 电源线

M9508G / M9508B 125mm (5")

459

Angle Grinder
Pengisar Sudut
角向磨光机

Slide Switch
Suis Gelangsar 滑动开关

- Compact and lightweight for high production work
Kompak dan ringan untuk kerja pengeluaran yang tinggi
紧凑轻巧型，更有效率地工作

Standard Equipment:
Side Grip, Lock Nut Wrench,
Wheel Cover

Continuous Rating Input 720W

Input Kuasa Berterusan 额定输入功率

Wheel Diameter 125mm (5")

Diameter Roda 轮片直径

No Load Speed (RPM) 11,000

Kelajuan Tanpa Beban 回转速数

Dimensions (L x W x H) 261x140x111mm

Dimensi 体积

Net Weight 1.9kg (4.1lbs)

Berat Bersih 净重

Power Supply Cord 2.0m (6.6ft)

Panjang Kord 电源线

M9503G / M9503B 125mm (5")

411

Angle Grinder
Pengisar Sudut
角向磨光机

Top Slide Switch
Suis Gelangsar Atas 顶部滑动开关
Convenient for left & right handed
Mudah diguna dengan tangan
kiri atau kanan 方便左右手

- Ideal for welders, fabricators, masons,
maintenance/ repair and more
Ideal untuk pengimpal, fabrikasi,
tukang batu, penyelenggaraan atau
pembaikan dan banyak lagi
适用于焊工、制造商、
泥瓦匠、维修与修理等

Standard Equipment:
Side Grip, Lock Nut Wrench

Continuous Rating Input 570W

Input Kuasa Berterusan 额定输入功率

Wheel Diameter 125mm (5")

Diameter Roda 轮片直径

No Load Speed (RPM) 11,000

Kelajuan Tanpa Beban 回转速数

Dimensions (L x W x H) 270x140x110mm

Dimensi 体积

Net Weight 2.0kg (4.4lbs)

Berat Bersih 净重

Power Supply Cord 2.0m (6.6ft)

Panjang Kord 电源线

M9002G / M9002B 125mm (5")

303

Angle Grinder
Pengisar Sudut
角向磨光机

Trigger Switch
Suis Pemicu 扳机开关

- High performance and durability
Prestasi dan ketahanan tinggi
高性能与持久耐用

Standard Equipment:
Side Grip, Lock Nut Wrench

Continuous Rating Input 1,050W

Input Kuasa Berterusan 额定输入功率

Wheel Diameter 125mm (5")

Diameter Roda 轮片直径

No Load Speed (RPM) 11,000

Kelajuan Tanpa Beban 回转速数

Dimensions (L x W x H) 361x140x124mm

Dimensi 体积

Net Weight 2.8kg (6.1lbs.)

Berat Bersih 净重

Power Supply Cord 2.0m (6.6ft)

Panjang Kord 电源线

M9000G / M9000B 180mm (7")

204

Angle Grinder
Pengisar Sudut
角向磨光机

Trigger Switch
Suis Pemicu 扳机开关

- **Powerful 2,000W motor for the most demanding applications**
Motor berkuasa 2,000W untuk aplikasi yang paling mencabar
强力2,000W马达适合严峻使用



Standard Equipment:
Side Grip, Lock Nut Wrench



Continuous Rating Input Input Kuasa Berterusan 额定输入功率	2,000W
Wheel Diameter Diameter Roda 轮片直径	180mm (7")
No Load Speed (RPM) Kelajuan Tanpa Beban 回转数	8,500
Dimensions (L x W x H) Dimensi 体积	466x200x138mm (18-3/8"x7-7/8"x5-7/16")
Net Weight Berat Bersih 净重	5.4kg (12.0lbs.)
Power Supply Cord Panjang Kord 电源线	2.0m (6.6ft.)

Cordless
Tempa Kord 无绳式

LED Flashlight
Lampu Suluh LED
LED照明灯

Vacuum Cleaner
Pembersih Vakuum
吸尘器

M9001G / M9001B 230mm (9")

204

Angle Grinder
Pengisar Sudut
角向磨光机

Trigger Switch
Suis Pemicu 扳机开关

- **Powerful 2,000W motor for the most demanding applications**
Motor berkuasa 2,000W untuk aplikasi yang paling mencabar
强力2,000W马达适合严峻使用



Standard Equipment:
Side Grip, Lock Nut Wrench



Continuous Rating Input Input Kuasa Berterusan 额定输入功率	2,000W
Wheel Diameter Diameter Roda 轮片直径	230mm (9")
No Load Speed (RPM) Kelajuan Tanpa Beban 回转数	6,600
Dimensions (L x W x H) Dimensi 体积	466x250x138mm (18-3/8"x9-7/8"x5-7/16")
Net Weight Berat Bersih 净重	5.7kg (12.6lbs.)
Power Supply Cord Panjang Kord 电源线	2.0m (6.6ft.)

Drilling | Fastening
Cecuil | Pengikat
钻孔 | 紧固

Impact Drilling | Demolition
Gerudi | Pemecah
石工钻孔 | 凿裂加工

M9400G / M9400B 100mm (4")

153

Belt Sander
Pengampelas
带式砂光机

- **Powerful 940W motor for faster material removal**
Motor berkuasa 940W untuk pengiraan yang lebih cepat
功率强大的940W马达提供更快的研磨



Standard Equipment: Abrasive Belt, Dust Bag (1233280), Carbon Plate, Step



Continuous Rating Input Input Kuasa Berterusan 额定输入功率	940W
Belt Size Saiz Tali Pinggang 皮带尺寸	100 x 610mm (4" x 24")
Belt Speed Kelajuan Tali Pinggang 皮带速度	380m/min (1,250ft/min)
Dimensions (L x W x H) Dimensi 体积	354x175x169mm (14"x6-7/8"x6-5/8")
Net Weight Berat Bersih 净重	6.2kg (13.7lbs.)
Power Supply Cord Panjang Kord 电源线	2.0m (6.6ft.)

Cutting
Pemotong
切割

Grinding | Sanding
Pengisar | Pelsin
研磨 | 砂磨

M9204G / M9204B 125mm (5")

419

Random Orbit Sander
Pengampelas
砂光机

- **Available with dust bag and also connectable to vacuum cleaners without adapter**
Dengan beg debu dan juga boleh disambungkan ke pembersih vakum tanpa penyusuai
配有防尘袋且可连接到没有连接器的吸尘器



Standard Equipment: Dust Bag, Abrasive Paper



Continuous Rating Input Input Kuasa Berterusan 额定输入功率	240W
Pad Size Saiz Pad 垫子尺寸	123mm (4-7/8")
Abrasive Paper Size Saiz Kertas Pasir 砂纸尺寸	125mm (5")
Orbits Per Minute (OPM) Bilangan Putaran 轨道转数	12,000
Strokes Per Minute (SPM) Kelajuan Strok 冲程速度	24,000
Orbit Diameter Jejaki Diameter 轨道直径	2.8mm (1/8")
Dimensions (L x W x H) Dimensi 体积	153x123x144mm (6"x4-7/8"x5-5/8")
Net Weight Berat Bersih 净重	1.2kg (2.6lbs)
Power Supply Cord Panjang Kord 电源线	2.0m (6.6ft.)

Sawing
Gergaji
锯切

Planing | Routing
Pengalir | Tunggam
刨削 | 雕刻

Others
Lain-lain
其他

M9202G / M9202B

419

Random Orbit Sander
Pengampelas
砂光机

- **Rocker on/off switch for efficient operation**
Suis gelangsar untuk operasi yang cekap
滑动式按钮开关有效操作



Standard Equipment: Abrasive Paper



Continuous Rating Input Input Kuasa Berterusan 额定输入功率	240W
Pad Size Saiz Pad 垫子尺寸	123mm (4-7/8")
Abrasive Disc Size Saiz Cakera 磨盘尺寸	125mm (5")
Orbits Per Minute (OPM) Bilangan Putaran 轨道转数	12,000
Strokes Per Minute (SPM) Kelajuan Strok 冲程速度	24,000
Orbit Diameter Jejaki Diameter 轨道直径	2.8mm (1/8")
Dimensions (L x W x H) Dimensi 体积	127x123x142mm (5"x4-7/8"x5-5/8")
Net Weight Berat Bersih 净重	1.1kg (2.4lbs)
Power Supply Cord Panjang Kord 电源线	2.0m (6.6ft.)

Outdoor Power Equipment
Alatan Kerja Luar
园林户外

M9200G / M9200B

419

Finishing Sander

Mesin Pengamplasan
砂光机

- 14,000OPM for fast and smooth finish sanding
14,000OPM untuk pelicin dengan cepat
14000OPM用于快速研磨



Standard Equipment: Abrasive paper



Continuous Rating Input Input Kuasa Berterusan 额定输入功率	180W
Pad Size Saiz Pad 垫子尺寸	112 x 102mm (4-3/8" x 4")
Abrasive Paper Size Saiz Kertas Pasir 砂纸尺寸	114 x 140mm (4-1/2" x 5-1/2")
Orbits Per Minute (OPM) Bilangan Putaran 轨道转速	14,000
Dimensions (L x W x H) Dimensi 体积	110x112x133mm (4-5/16"x4-3/8"x5-1/4")
Net Weight Berat Bersih 净重	0.9kg (2lbs)
Power Supply Cord Panjang Kord 电源线	2.0m (6.6ft)

M9201G / M9201B

64

Finishing Sander

Mesin Pengamplasan
砂光机

- Compact and lightweight body for better handling
Padat dan ringan
小巧轻便的机身易于操纵



Standard Equipment: Abrasive Paper



Continuous Rating input Input Kuasa Berterusan 额定输入功率	180W
Pad Size Saiz Pad 垫子尺寸	93 x 185mm (3-5/8" x 7-1/4")
Abrasive Paper Size Saiz Kertas Pasir 砂纸尺寸	93 x 228mm (3-5/8" x 9")
Orbits Per Minute (OPM) Bilangan Putaran 轨道转速	12,000
Dimensions (L x W x H) Dimensi 体积	214x92x147mm (8-3/8"x3-5/8"x5-3/4")
Net Weight Berat Bersih 净重	1.4kg (3.1lbs)
Power Supply Cord Panjang Kord 电源线	2.0m (6.6ft)

M5801G / M5801B 185mm (7-1/4")

303

Circular Saw

Gergaji Piring
圆锯

- High performance and durability
Prestasi dan ketahanan tinggi
高性能兼耐用



Standard Equipment: TCT Saw Blade, Guide Rule, Hex Wrench



Continuous Rating Input Input Kuasa Berterusan 额定输入功率	1,050W
Blade Diameter Diameter Bilah 锯片直径	185mm (7-1/4")
Max Cutting Capacity Kapasiti Pemotongan Maksimum 最大切割能力	90°: 66mm (2-5/8") 45°: 44mm (1-3/4")
No Load Speed (RPM) Kelajuan Tanpa Beban 回转数	4,900
Dimensions (L x W x H) Dimensi 体积	284x231x243mm (11-1/8"x9-1/8"x9-9/16")
Net Weight Berat Bersih 净重	3.7kg (8.1lbs)
Power Supply Cord Panjang Kord 电源线	2.0m (6.6ft)

M2300G / M2300B 255mm (10")

JM23000123

Compound Miter Saw

Gergaji Komaun Miter
斜断锯

- Powerful 1,500W motor
Motor berkuasa 1,500W
强力1,500W马达



Standard Equipment: Wrench, Dust Bag, Triangular Rule, Vise Assembly, Set Plate, Verticle Vise



Continuous Rating Input Input Kuasa Berterusan 额定输入功率	1,500W
Blade Diameter Diameter Bilah 锯片直径	255mm (10")
Miter Angle Sudut Miter 斜接角	45°L / 45°R
Bevel Angle Sudut Bevel 斜角	45°L
Max Cutting Capacity Kapasiti Pemotongan Maksimum 最大切割能力	90° Miter: 75 x 130mm (2-15/16" x 5-1/8") 45° Miter, L/R: 75 x 90mm (2-15/16" x 3-9/16")
No Load Speed (RPM) Kelajuan Tanpa Beban 回转数	4,200
Dimensions (L x W x H) Dimensi 体积	610x485x515mm (24"x19-1/8"x20-1/4")
Net Weight Berat Bersih 净重	14.7kg (32.5lbs)
Power Supply Cord Panjang Kord 电源线	2.5m (8.2ft)

M4302G / M4302B

411

Jig Saw

Gergaji Jig
线锯机

- Heavy duty aluminum gear housing for increased durability
Gear aluminium tugas berat untuk meningkatkan ketahanan
重型铝制齿轮组件结构提高耐用性



Standard Equipment: 2x Jig Saw Blade (B-13 & No. 51), Hex Wrench



Continuous Rating Input Input Kuasa Berterusan 额定输入功率	450W
Max Cutting Capacity at 90° Kapasiti Pemotongan Maksimum 最大切割能力	Wood: 55mm (2-3/16") Steel: 6mm (1/4")
Length of Stroke Panjang Strok 冲程长度	26mm (1")
Strokes Per Minute (SPM) Kelajuan Strok 冲程速度	0 - 3,100
Dimensions (L x W x H) Dimensi 体积	219x85x191mm (8-5/8"x3-3/8"x7-1/2")
Net Weight Berat Bersih 净重	2.5kg (5.5lbs.)
Power Supply Cord Panjang Kord 电源线	2.0m (6.6ft)

M4301G / M4301B

64

Jig Saw
Gergaji Jig
线锯机

- **Powerful 450W motor**
Motor berkuasa 450W
强力450W马达



Standard Equipment: Jig Saw Blade (B-10), Hex Wrench



Continuous Rating Input Input Kuasa Berterusan 额定输入功率	450W
Max Cutting Capacity at 90° Kapasiti Pemotongan Maksimum 最大切割能力	Wood: 65mm (2-9/16") Steel: 6mm (1/4")
Length of Stroke Panjang Strok 冲程长度	18mm (11/16")
Strokes Per Minute (SPM) Kelajuan Strok 冲程速度	0 - 3,100
Dimensions (L x W x H) Dimensi 体积	214x75x202mm (8-3/8"x2-15/16"x8")
Net Weight Berat Bersih 净重	1.9kg (4.1lbs)
Power Supply Cord Panjang Kord 电源线	2.0m (6.6ft)

M4501G / M4501B

303

Recipro Saw
Gergaji Resipro
往复锯

- **Powerful 1,010W motor for improved performance**
Motor berkuasa 1,010W untuk prestasi lebih baik
强劲的1,010W马达提高性能



Continuous Rating Input Input Kuasa Berterusan 额定输入功率	1,010W
Length of Stroke Panjang Strok 冲程长度	28mm (1-1/8")
Strokes Per Minute (SPM) Kelajuan Strok 冲程速度	0 - 2,800
Capacity Kapasiti 能力	Pipe : 130mm (5-1/8") Wood: 255mm (10")
Dimensions (L x W x H) Dimensi 体积	457x98x170mm (18"x3-7/8"x6-11/16")
Net Weight Berat Bersih 净重	3.2kg (7lbs)
Power Supply Cord Panjang Kord 电源线	2.0m (6.6ft)

M0400G / M0400B 110mm (4-3/8")

303

Cutter
Pemotong
切割机

- **Powerful 1,200W motor**
Motor berkuasa 1,200W
强力1,200W马达



Standard Equipment: Wrench, Hex Wrench
(Tool does not come with Diamond Wheel)



Continuous Rating Input Input Kuasa Berterusan 额定输入功率	1,200W
Blade Diameter Diameter Bilah 锯片直径	110mm (4-3/8")
Max Cutting Capacity Kapasiti Pemotongan Maksimum 最大切割能力	90°: 32mm (1-1/4")
No Load Speed (RPM) Kelajuan Tanpa Beban 回转数	13,800
Dimensions (L x W x H) Dimensi 体积	224x195x164mm (8-7/8"x7-5/8"x6-1/2")
Net Weight Berat Bersih 净重	2.5kg (5.6lbs.)
Power Supply Cord Panjang Kord 电源线	2.0m (6.6ft)

M4100G / M4100B 110mm (4-3/8")

303

Cutter
Pemotong
切割机

- **Compact and lightweight for reduced operator fatigue**
Kompak dan ringan untuk mengurangkan keletihan pengguna
小巧轻便, 减少疲劳



Standard Equipment: Wrench, Hex Wrench, Water Supply Set
(Tool does not come with Diamond Wheel)



Continuous Rating Input Input Kuasa Berterusan 额定输入功率	1,200W
Blade Diameter Diameter Bilah 锯片直径	110mm (4-3/8")
Max Cutting Capacity Kapasiti Pemotongan Maksimum 最大切割能力	90°: 32mm (1-1/4")
No Load Speed (RPM) Kelajuan Tanpa Beban 回转数	13,000
Dimensions (L x W x H) Dimensi 体积	227x209x166mm (8-15/16"x8-1/4"x6-1/2")
Net Weight Berat Bersih 净重	2.9kg (6.4lbs)
Power Supply Cord Panjang Kord 电源线	2.0m (6.6ft.)

M2400G 355mm (14")

203

Portable Cut-off
Mesin Pemotong
型材切割机

- **Powerful 2,000W motor**
Motor berkuasa 2,000W
强力2,000W马达



Standard Equipment: Abrasive Cut-Off Wheel, Socket Wrench



Continuous Rating Input Input Kuasa Berterusan 额定输入功率	2,000W
Wheel Diameter Diameter Roda 轮片直径	355mm (14")
No Load Speed (RPM) Kelajuan Tanpa Beban 回转数	3,800
Dimensions (L x W x H) Dimensi 体积	500x280x620mm (19-3/4"x11"x24-3/8")
Net Weight Berat Bersih 净重	15.7kg (34.6lbs)
Power Supply Cord Panjang Kord 电源线	2.5m (8.2ft)

Cordless
Tempt Kord 无绳式

LED Flashlight
Lampu Suluh LED
LED照明灯

Vacuum Cleaner
Pembersih Vakuum
吸尘器

Drilling | Fastening
Gerudi | Pengikat
钻孔 | 紧固

Impact Drilling | Demolition
Gerudi | Pemecah
石工钻孔 | 砸裂加工

Cutting
Pemotong
切割

Grinding | Sanding
Pengisar | Pelsin
研磨 | 打磨

Sawing
Gergaji
锯切

Planing | Routing
Pengaliran | Tanggaman
刨削 | 雕刻

Others
Lain-lain
其他

Outdoor Power Equipment
Alatan Kerja Luar
园机/户外

M2401G / M2401B 355mm (14")

203

Portable Cut-off

Mesin Pemotong

型材切割机

- Large cutting capacity; Cuts up to 127mm (5") round and 102mm (4") x 194mm (7-5/8") rectangular
- Kapasiti pemotongan tinggi
切割能力高



Standard Equipment: Abrasive Cut-Off Wheel, Hex Wrench



Continuous Rating Input Input Kuasa Berterusan 额定输入功率	2,000W
Wheel Diameter Diameter Roda 轮片直径	355mm (14")
No Load Speed (RPM) Kelajuan Tanpa Beban 回转速数	3,800
Dimensions (L x W x H) Dimensi 体积	500x280x620mm (19-3/4"x11"x24-3/8")
Net Weight Berat Bersih 净重	13.7kg (30.2lbs.)
Power Supply Cord Panjang Kord 电源线	2.5m (8.2ft.)

M1100G / M1100B 82mm (3-1/4")

303

Planer

Planer

电刨

- Easy blade setting system for fast blade installation
- Sistem pemasangan bilah mudah
刀片易安装系统



Standard Equipment: Planer Blade, Sharpening Holder Assembly (for resharpenable blade), Blade Gauge, Socket Wrench, Guide Rule



Continuous Rating Input Input Kuasa Berterusan 额定输入功率	750W
Planing Width Lebar Pelan 刨削宽度	82mm (3-1/4")
Planing Depth Kedalaman Pelan 刨削深度	3mm (1/8")
No Load Speed (RPM) Kelajuan Tanpa Beban 回转速数	18,000
Dimensions (L x W x H) Dimensi 体积	390x175x140mm (15-3/8"x6-7/8"x5-1/2")
Net Weight Berat Bersih 净重	4.6kg (10.2lbs.)
Power Supply Cord Panjang Kord 电源线	2.0m (6.6ft.)

M1901G / M1901B | M1902G / M1902B 82mm (3-1/4")

411

Planer

Planer

电刨

- High performance and durability
- Prestasi dan ketahanan tinggi
高性能耐用



Standard Equipment:

M1901G: Planer Blade, Sharpening Holder Assembly (for resharpenable blade), Blade Gauge, Socket Wrench, Guide Rule

M1902G: Planer Blade, Sharpening Holder Assembly (for resharpenable blade), Blade Gauge, Guide Rule



Continuous Rating Input Input Kuasa Berterusan 额定输入功率	580W
Planing Width Lebar Pelan 刨削宽度	82mm (3-1/4")
Planing Depth Kedalaman Pelan 刨削深度	2mm (1/16") M1901G 1mm (1/32") M1902G
No Load Speed (RPM) Kelajuan Tanpa Beban 回转速数	16,000
Dimensions (L x W x H) Dimensi 体积	285x157x160mm (11-1/4"x6-3/16"x6-5/16")
Net Weight Berat Bersih 净重	2.8 - 2.9kg (6.1 - 6.4lbs)
Power Supply Cord Panjang Kord 电源线	2.0m (6.6ft.)

M3600G / M3600B 12mm (1/2")

203

Router

Pemangkas

雕刻机

- Conveniently located plunge lock lever for efficient operation
- Pelarasn tuil yang mudah untuk operasi yang cekap
便利的插入式锁定杆可实现高效操作



Standard Equipment: Straight Guide, Templet Guide, Guide Holder, Collet Sleeve, Straight Bit, Wrench



Continuous Rating Input Input Kuasa Berterusan 额定输入功率	1,650W
Collet Capacity Kapasiti Collet 夹头直径	12mm (1/2")
Plunge Capacity Kapasiti Plunge 能力	0 - 60mm (0 - 2-3/8")
No Load Speed (RPM) Kelajuan Tanpa Beban 回转速数	22,000
Dimensions (L x W x H) Dimensi 体积	284x148x300mm (11-1/8"x5-7/16"x11-3/4")
Net Weight Berat Bersih 净重	5.5kg (12.2lbs.)
Power Supply Cord Panjang Kord 电源线	2.0m (6.6ft.)

M3601G / M3601B 6mm (1/4"), 8mm (3/8")

106

Router

Pemangkas

雕刻机

- Powerful 900W motor
- Motor berkuasa 900W
强力900W马达



Standard Equipment: Straight Guide, Straight Bit (733238-9), Wrench



Continuous Rating Input Input Kuasa Berterusan 额定输入功率	900W
Collet Capacity Kapasiti Collet 夹头直径	6 mm (1/4") 8 mm (3/8")
Plunge Capacity Kapasiti Plunge 能力	0 - 35mm (0 - 1-3/8")
No Load Speed (RPM) Kelajuan Tanpa Beban 回转速数	27,000
Dimensions (L x W x H) Dimensi 体积	256x110x218mm (10-1/8"x4-5/16"x8-5/8")
Net Weight Berat Bersih 净重	2.7kg (6.0lbs)
Power Supply Cord Panjang Kord 电源线	2.0m (6.6ft.)

M9800G / M9800B

459

Multi Tool

Mesin Pemotong Berbilang Fungsi
多功能切割打磨机

Lightweight Design

Reka bentuk yang padat dan ringan
紧凑轻巧的设计



Standard Equipment: Hex Wrench



Oscillations Per Minute (OPM) Kelajuan Ayunan 摆动速度	15,000 - 22,000
Oscillation Angle Sudut Ayunan 摆动角度	Left: 1.6° Right: 1.6° Total: 3.2°
Dimensions (L x W x H) Dimensi 体积	283x68x98mm (11-1/8"x2-11/16"x3-7/8")
Net Weight Berat Bersih 净重	1.2 - 1.3kg (2.7 - 3.0 lbs.)
Power Supply Cord Panjang Kord 电源线	2.0m (6.6ft)

M3700G / M3700B 6mm (1/4")

411

Trimmer

Mesin Perapi
修边雕刻机

Compact and lightweight body for better handling

Padat dan ringan
小巧轻便的机身易于操纵



Standard Equipment: Trimmer Guide, Straight Guide, Templet Guide, Straight Bit, Chip Deflector, Wrench



Continuous Rating Input Input Kuasa Berterusan 额定输入功率	530W
Collet Capacity Kapasiti Collet 夹头直径	6mm or 1/4"
Plunge Capacity Kapasiti Plunge 铣削能力	0 - 42mm (0 - 1-5/8")
No Load Speed (RPM) Kelajuan Tanpa Beban 回转数	35,000
Dimensions (L x W x H) Dimensi 体积	82x90x199mm (3-1/4"x3-1/2"x7-7/8")
Net Weight Berat Bersih 净重	1.4kg (3.1lbs.)
Power Supply Cord Panjang Kord 电源线	2.0m (6.6ft.)

M3701G / M3701B 6mm (1/4")

411

Trimmer

Mesin Perapi
修边雕刻机

Aluminium housing for higher durability

Cangkang aluminium untuk ketahanan yang lebih tinggi
铝外壳更高的耐用性



Standard Equipment: Trimmer Guide, Straight Guide Assembly, Templet Guide, Straight Bit (733238A9), Chip Deflector, Wrench

M4000G / M4000B

85

Blower

Mesin Blower
吹风机

Compact and lightweight increased operator comfort

Kompak dan ringan operasi yang selesa
小巧轻便操作舒适



Standard Equipment: Nozzle Assembly, Sash Nozzle



Continuous Rating Input Input Kuasa Berterusan 额定输入功率	530W
Air Volume Isipadu Angin 风量	1.2-2.9m³/min
No Load Speed (RPM) Kelajuan Tanpa Beban 回转数	8,500 - 16,000
Dimensions (L x W x H) Dimensi 体积	427x161x212mm (16-3/4"x6-3/8"x8-3/8")
Net Weight Berat Bersih 净重	1.5kg (3.4lbs)
Power Supply Cord Panjang Kord 电源线	2.0m (6.6ft)

M4001G / M4001B

303

Blower

Mesin Blower
吹风机

Two tools in one; quickly converts to a vacuum for added versatility

Alat 2 dalam 1, vakum dan blower untuk fleksibiliti tambahan
一机2用, 集尘与吹风



Standard Equipment: Nozzle, Dust Bag



Continuous Rating Input Input Kuasa Berterusan 额定输入功率	600W
Max Air Volume Isipadu Angin Maksimum 最大风量	0 - 4.1m³/min
Max Air Velocity Velositi Angin Maksimum 最大风速	0 - 91m/s
Air Pressure Tekanan Udara 气压	0 - 5.7kPa
No Load Speed (RPM) Kelajuan Tanpa Beban 回转数	0 - 16,000
Dimensions (L x W x H) Dimensi 体积	480x185x178mm (18-7/8"x7-1/4"x7")
Net Weight Berat Bersih 净重	1.9 - 2.0kg (4.3 - 4.5lbs)
Power Supply Cord Panjang Kord 电源线	2.0m (6.6ft.)

Cordless
Tempa Kord 无绳式

LED Flashlight
Lampu Suluh LED
LED照明灯

Vacuum Cleaner
Pembersih Vakum
吸尘器

Drilling | Fastening
Gerudi | Pengikat
钻孔 | 紧固

Impact Drilling | Demolition
Gerudi | Pemecah
石工钻孔 | 拆毁加工

Cutting
Pemotong
切割

Grinding | Sanding
Pengisar | Pelsin
研磨 | 打磨

Sawing
Gergaji
锯切

Planing | Routing
Pengaliran | Tanggaman
刨削 | 雕刻

Others
Lain-lain
其他

Outdoor Power Equipment
Alatan Kerja Luar
园机/户外

Makita
imt



12 MONTHS WARRANTY

Waranti 12 bulan • 12个月保修期

* Applicable on all Makita Tools, except heat gun (period of 6 months warranty)

* Untuk semua Makita Tool, kecuali Heat Gun (waranti 6 bulan) | *有效于所有 Makita 工具, 热风机除外 (享有6个月保修)

Makita Standard Warranty

Piawaian Waranti Makita • Makita 保修服务说明

Every Makita Product is thoroughly inspected and tested before leaving the factory. Subject to the following terms and conditions, the Product (Tool, Battery, Charger) is warranty against defective materials and manufacturing defects for a period of twelve (12) months from the date of purchase (applicable for purchases made from 1st October 2017 onwards) as evidenced from the sale or tax invoice (with tool serial number) and Makita Authorised Service Centre or Makita Service Centre undertakes, at our option, to repair or replace, free of charge.

Conditions of warranty

This warranty will NOT cover or shall be null & void in any of the following events even during the warranty period:-

1. Damage resulting from normal wear and tear (Carbon brush/ holder/ cap, switch, gear, grinding/ cutting wheels, bits, saw blades, etc..)
2. Damage resulting from use of improper accessories, non genuine replacement parts, disassembly, tampering, alteration and repairing in any way that affects its performance.
3. Damage resulting from negligence, accident, disaster, improper storage or maintenance, abuse and misuse in evident caused by overloading the tool beyond its capacity.
4. Abnormal voltage or the usage of generator, wrong usage not in accordance with the Operating Manual.
5. If the serial number on the tool, seal on the battery and charger has been defaced or removed.
6. If the receipt or invoice that display the date of purchase could not be present.

Setiap produk Makita diperiksa dan diuji dengan teliti dari kilang. Waranti produk (Alat, Bateri, Pengcas Bateri) tertakluk kepada terma dan syarat berikut, sekiranya terdapat kecacatan pada bahan atau kerosakan disebabkan pemuatan dari kilang dalam tempoh 12 bulan bermula dari tarikh pembelian (untuk pembelian bermula dari 1hb Oktober 2017), dengan bukti pembelian pada resit atau invoice bercukai (dengan nombor siri alat), terikat kepada keputusan Pusat Servis diiktiraf oleh Makita atau Pusat Servis Makita untuk membaiki secara percuma.

Syarat-syarat waranti

Waranti ini TIDAK akan meliputi atau akan dibatalkan & tidak sah sekiranya berlaku salah satu kejadian yang berikut semasa berada dalam tempoh waranti:-

1. Kerosakan akibat daripada haus dan lusuh biasa (karbon/ pemegang/ tukup, suis, gear, cakera mencanai/ memotong, mata gerudi, bilah gergaji, dll..)
2. Kerosakan akibat daripada penggunaan aksesori yang tidak sesuai, alat ganti yang tidak asli, pembukaan, perbuatan merosakkan, pengubahan dan pembaikan yang mempengaruhi prestasinya.
3. Kerosakan akibat kecuaihan, kemalangan, bencana, penyimpanan atau penyelenggaraan yang tidak wajar, penyalahgunaan yang jelas disebabkan oleh beban yang melebihi kemampuannya.
4. Voltan tidak normal atau penggunaan penjana, cara penggunaan yang salah dan tidak mengikut Manual Operasi.
5. Jika nombor siri pada alat, balut/ cap pada bateri dan pengcas tercacat atau ditanggalkan.
6. Jika resit atau invoice yang memaparkan tarikh pembelian tidak dapat ditunjukkan.

每个 Makita 产品生产制造都经过彻底检查和测试并严格把关确认品质。根据以下保修条件, 产品保修 (工具, 电池, 充电器) 涵盖材质和生产上的瑕疵, 于销售单据 (附上工具生产编号) 与税收发票上所显示的购买日期起十二 (12) 个月内 (从1-10-2017选购开始), 以 Makita 授权服务中心或 Makita 服务中心的判断为准而提供无收费维修。

保修规定

Makita 均不承担基于以下违反保修行为而造成的产品故障、工作异常或损坏的责任。

1. 正常消耗零件。(例如: 碳刷/支架/盖, 开关, 齿轮, 研磨/切割片, 钻头, 锯片等)。
2. 使用不正确的配件, 更换非原装零件, 拆除和改造等任何影响其性能而引起的损坏。
3. 因人为疏忽, 意外, 灾难, 不正确的保管或保养, 滥用和误用, 超出工具负荷能力等原因导致的损坏。
4. 使用非工具所规定电压和发电机, 未按说明书安装及使用工具。
5. 工具上的编号, 电池和充电器上的印章已被污损或除去。
6. 无法提供销售单据或税收发票。

** Makita reserved the rights of amend conditions of warranty without prior notice. In the event of differences arising between the English, Bahasa Malaysia and Chinese versions, the English version shall prevail.
Makita berhak untuk meminda syarat-syarat waranti pada bila-bila masa tanpa sebarang notis. Jika terdapat perbezaan antara bahasa, maka maklumat versi Bahasa Inggeris harus digunapakai.
Makita 保留修改保修规定的权利, 恕不另行通知。如果内容有任何差异或不一致, 概以英文版本为准。



Please visit our website for contact of nearest
AUTHORISED SERVICE CENTRE
www.makita.my/Customer-Services/

Sila layari laman web kami untuk maklumat Pusat Servis Diiktiraf
请浏览我们的网页以获取授权服务中心的详细信息



MAKITA SERVICE CENTRE
SERVIS & BAIK-PULIH 售后服务及维修
www.makita.my/makita-service-centre/



PRODUCT RANGE
SIRI PRODUK 产品系列
www.makita.my/cordless-tools-batteries/



ACCESSORIES
AKSESORI 配件
www.makita.my/accessories/



ABOUT US
MENGENAI KAMI 公司简介
www.makita.my/makita-malaysia/



LATEST INFO & PROMOTION
INFO & PROMOSI TERKINI 最新信息和促销
www.makita.my/news-events/



E-CATALOGUE
KATALOG PRODUK 商品目录
<https://www.makita.my/catalogue/>





TRADEMARK | Tanda Dagangan | 商标



Tanda dagang di atas telah dipatenkan oleh Perbadanan Harta Intelek Malaysia. Makita Power Tools (Malaysia) Sdn. Bhd. berhak untuk mengambil tindakan undang-undang bagi mana-mana pelanggaran tanda dagang di atas, termasuk perkilangan, borong atau menjual sama ada mesin atau aksesori yang dicetak dengan tanda di atas tanpa mendapat kebenaran Makita Power Tools (Malaysia) Sdn. Bhd

上述商标已经在马来西亚知识产权公司办理注册专利。对于任何侵犯上述商标专用权之行为，包括未经许可制造，批发或零售附有上述商标之电动工具及配件，本公司必定追究法律责任。

Above trademarks have been patented at the Intellectual Property Corporation of Malaysia. Makita Power Tools (Malaysia) Sdn. Bhd. reserves the right to take legal action for any infringement of the above trademarks, including manufacturing, wholesale or selling either the power tools or accessories printed with the above trademarks without getting permission of Makita Power Tools (Malaysia) Sdn. Bhd.

*In the event of differences arising between the English, Bahasa Malaysia and Chinese versions, the English version shall prevail.

Jika terdapat perbezaan antara bahasa, maka maklumat versi Bahasa Inggeris harus digunakan. 如果内容有任何差异或不一致，概以英文版本为准。

*Items of standard equipment and specifications may vary by country or area. Net weight and dimensions may differ depending on the type of battery(ies) used. All pictures shown are for illustration purposes only.

Spesifikasi standard mungkin berbeza mengikut negara. Berat bersih dan dimensi berbeza bergantung pada jenis bateri yang digunakan. Imej yang ditunjukkan hanya untuk tujuan ilustrasi sahaja. 注：规格可能因销往国家之不同而异。重量与尺寸因附件(包括电池组)而异。图片仅供参考。



Makita Power Tools (Malaysia) Sdn. Bhd. Co. Registration No.: 201301001778 (1031615-M)

HQ & Service Centre
总部和服务与展示中心

Lot 824, Jalan Subang 5, Subang Industrial Area,
47500 Subang Jaya, Selangor.
Tel: 03-8023 0824 (General) | Fax: 03-8022 1448
03-8022 1443 (Service)

Johor (Johor Bahru) Service Centre
柔佛(新山)服务与展示中心

No.12 & 14, Jalan Rosmerah 2/9,
Taman Johor Jaya,
81100 Johor Bahru, Johor.
Tel: 07-364 9406 | Fax: 07-364 9407

Sarawak (Kuching) Service Centre
砂拉越(古晋)服务与展示中心

Lot 1227, Lorong Demak Indah 2A,
Demak Laut Industrial Area, Phase 2A,
93050 Kuching, Sarawak.
Tel: 082-496 800 | Fax: 082-496 900

Sabah (Kota Kinabalu) Service Centre
沙巴(亚庇)服务与展示中心

Lot 19, Jalan Buah Duku,
Kolombong Light Industrial Estate, Off Kolombong,
Kolombong Zone 1, 88450 Inanam, Kota Kinabalu, Sabah.
Tel: 088-388 278 | Fax: 088-388 279



www.makita.my
makita@makita.my